



Rainbow[®]
Agencia de Comunicación

CATÁLOGO 2018-2019

226



AGENDAS

227

TERRA

229

CLÁSICAS

232

ELITE

8



BEBIDAS

9

CILINDROS

9

- CILINDROS PLÁSTICOS

33

- CILINDROS METÁLICOS

39

TERMOS

64

VASOS

68

TAZAS

462



BIENESTAR

463

SALUD

463

- ARTÍCULOS PARA MÉDICOS

465

- PASTILLEROS

470

- HIGIENE Y CUIDADO PERSONAL

480

- ANTI-STRESS

489

BELLEZA

489

- ESPEJOS Y CEPILLOS

493

- COSTUREROS

494

- SETS DE BROCHAS Y MANICURE

498

- COSMETIQUERAS Y ALHAJEROS

504



HERRAMIENTAS

505

NAVAJAS

507

LÁMPARAS

513

DESARMADORES Y FLEXÓMETROS

518

**SET DE HERRAMIENTAS Y
MULTIFUNCIONALES**

525

AUTOMÓVIL

420



HOGAR

421

ACCESORIOS DE COCINA

432

BBQ

436

BAR

448

RELOJES

448

- RELOJES DE ESCRITORIO

450

- RELOJES DE PARED

451

PORTARRETRATOS

459

MASCOTAS

530



NIÑOS

531

ARTÍCULOS ESCOLARES

539

JUGUETES

546

ALCANCÍAS

84



OFICINA

85

ESCRITURA

85

- BOLÍGRAFOS PLÁSTICOS

114

- BOLÍGRAFOS FUNCIONES

131

- BOLÍGRAFOS METÁLICOS

143

LLAVEROS

143

- LLAVEROS FUNCIONES

155

- LLAVEROS METÁLICOS

168

ACCESORIOS DE ESCRITORIO

168

- SET PARA ESCRITORIO Y ORGANIZADORES

176

- TARJETEROS

180

- PORTA NOTAS

186

- CALCULADORAS

188

- PORTAGAFETES

191

- CALENDARIOS

192

LIBRETAS Y CARPETAS

192

- LIBRETAS DE BOLSILLO

197

- LIBRETAS ECOLÓGICAS

205

- LIBRETAS DE ESCRITORIO

217

- CARPETAS

354



TECNOLOGÍA

355

SMARTPHONE Y TABLET

380

AUDIO

381

- AUDÍFONOS

391

- BOCINAS

398

CÓMPUTO

405

USB

234



TEXTILES

235

GORRAS Y SOMBREROS

246

PLAYERAS

251

CHAMARRAS Y CHALECOS

256

PARAGUAS E IMPERMEABLES

264

HIELERAS Y LONCHERAS

282

BOLSAS

303

MOCHILAS

303

- MOCHILAS ESCOLARES

315

- MOCHILAS CASUALES

322

- MOCHILAS EJECUTIVAS

326

PORTAFOLIOS

334

MALETAS

334

- MALETAS SPORT

345

- MALETAS DE VIAJE

548



TIEMPO LIBRE

549

VIAJE

549

- ACCESORIOS PARA PLAYA

553

- COMPLEMENTOS DE EQUIPAJE

562

- CARTERAS Y PORTA DOCUMENTOS

566

DEPORTES

567

- SOCCER

569

- GOLF

572

- ACCESORIOS DEPORTIVOS

573

ENTRETENIMIENTO



CATÁLOGO
2018-2019

XO-TOOL[®]



STARTECHNO[®]



ZEGNO®
ESCRITURA



ZEGNO®



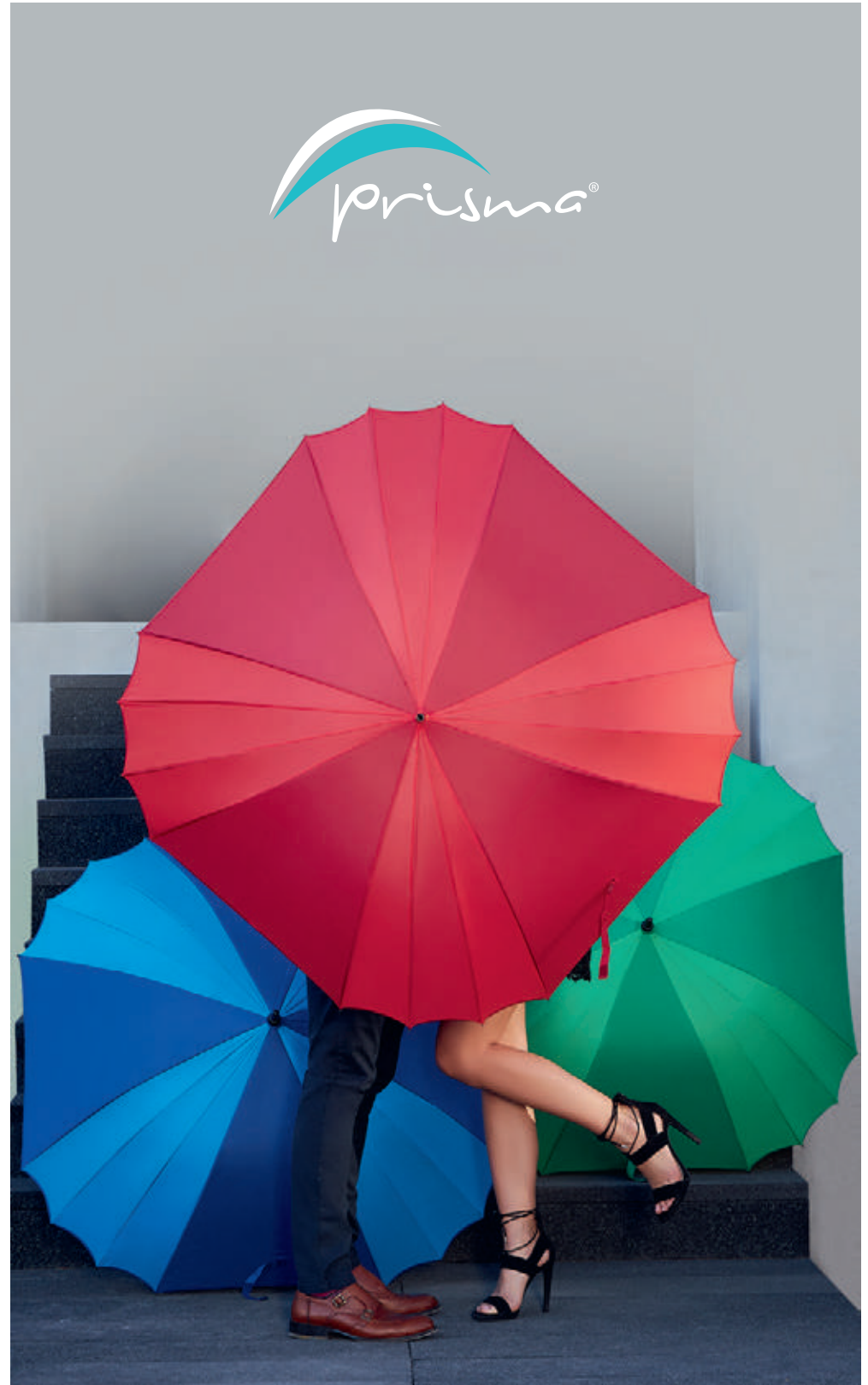



tossh[®]





BEBIDAS





LAS ESPECIFICACIONES ESTÁN SUJETAS A CAMBIOS Y MEJORAS SIN PREVIO AVISO. EN LA REALIDAD EL PRODUCTO PUEDE SER DIFERENTE DE LAS IMÁGENES MOSTRADAS EN ESTE CATÁLOGO. LAS ÁREAS Y TÉCNICAS DE IMPRESIÓN Y GRABADO QUE SE MUESTRAN EN ESTE CATÁLOGO SON RECOMENDACIONES; LA APLICACIÓN DE CUALQUIER TÉCNICA DE IMPRESIÓN, GRABADO, ETC., SOBRE LOS ARTÍCULOS ES RESPONSABILIDAD DE QUIEN LO REALIZA. LOS LOGOTIPOS Y LAS MARCAS QUE SE PUBLICAN EN ESTE CATÁLOGO SON DE CARÁCTER ILUSTRATIVO Y SON PROPIEDAD DE QUIEN EJERCE LOS DERECHOS LEGALES SOBRE DE Ellas. LAS FOTOGRAFÍAS CUENTAN CON DERECHOS DE AUTOR POR LO QUE LA REPRODUCCIÓN TOTAL O PARCIAL REQUIERE PERMISO POR ESCRITO DEL MISMO.

COPYRIGHT © DERECHOS RESERVADOS



CILINDROS



A



■ ANF 049

CILINDRO CHEMIN

Material: PET / Silicón

Medida: 7.4 x 24.5 cm

Área de Impresión: 5 x 13 cm

Técnica de Impresión: Serigrafía / Tampografía

Capacidad: 850 ml

Colores: A/N/O/P/R/V/Y

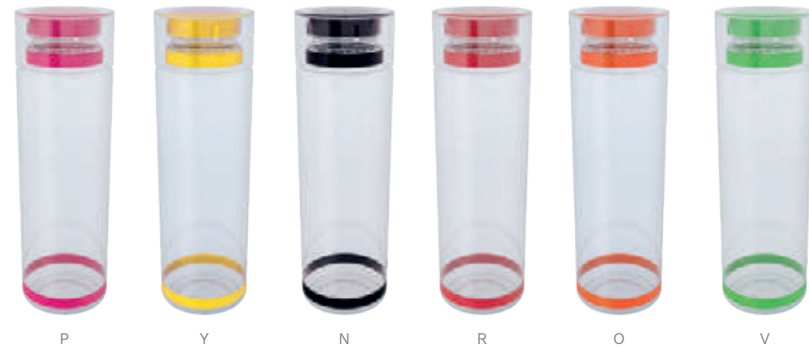
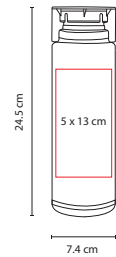

P

Y

N

R

O

V

Sistema de rosca twist-off que permite abrir y cerrar la tapa en un giro.
Cuenta con dos bandas elásticas de silicón.



O



N



M



■ ANF 006

CILINDRO LAKE

Material: PET

Medida: 7.4 x 24.5 cm

Área de Impresión: 5 x 13 cm

Técnica de Impresión: Serigrafía / Tampografía

Capacidad: 850 ml

Colores: A/B/H/M/N/O/P/R/V/Y

Colores GTM: A/B/H/N/O/P/R/V/Y



R



ROSCA



V



H



Y



A



B



P

Sistema de rosca twist-off que permite abrir y cerrar la tapa en un giro.





BS



■ ANF 003

CILINDRO TWISTER

Material: PET
 Medida: 7.5 x 24.7 cm
 Área de Impresión: 3.8 x 5.8 cm
 Técnica de Impresión: Serigrafía / Tampografía
 Capacidad: 700 ml

Colores: A/B/H/R/V/Y Translúcidos / AS/BS/RS Sólidos

Colores GTM: A/B/H/R/V/Y Translúcidos / AS/BS/RS Sólidos

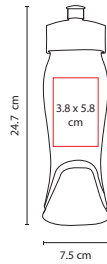

V

B

AS

RS

Y

R

H

A

Tapa con válvula de seguridad.



A



■ ANF 037

CILINDRO NEIVA

Material: Plástico
 Medida: 8.1 x 26 cm
 Área de Impresión: 6 x 5 cm
 Técnica de Impresión: Serigrafía / Tampografía
 Capacidad: 750 ml

Colores: A/H/R

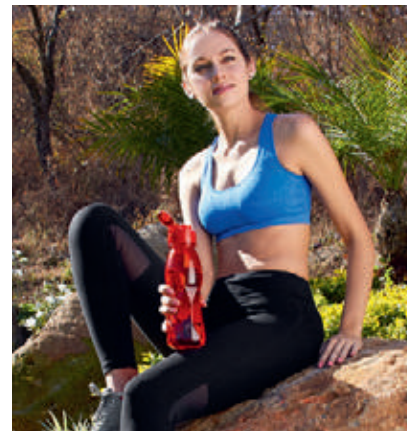
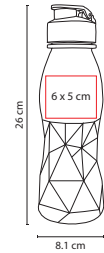

H



R

Tapa con válvula de seguridad.



B



H



R



O



■ ANF 040

CILINDRO TRIBEC

Material: PET
 Medida: 7.3 x 24.5 cm
 Área de Impresión: 4.5 x 17 cm
 Técnica de Impresión: Serigrafía
 Capacidad: 960 ml
 Colores: A/B/H/O/R/V/Y
 ■ ■ Colores GTM: A/B/R

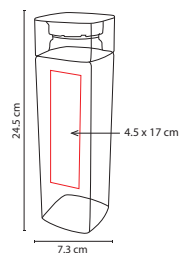

A



V



Y



Sistema de rosca twist-off que permite abrir y cerrar la tapa en un giro.





V



ROSCA

TEXTURA



■ ANF 021

CILINDRO VAUS

Material: PET

Medida: 7.3 x 25 cm

Área de Impresión: 5 x 9 cm

Técnica de Impresión: Serigrafía /

Tampografía

Capacidad: 700 ml

Colores: A/B/H/R/V/Y

Colores GTM: A/B/R/V

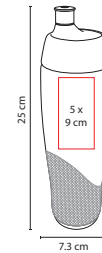

R



H



B



A



Y

Incluye válvula de seguridad y rosca twist-off que permite abrir y cerrar la tapa en un giro.



R



■ ANF 023

CILINDRO RELIEVE CORAZÓN

Material: PET
 Medida: 7.5 x 24.5 cm
 Área de Impresión: 5 x 9 cm
 Técnica de Impresión: Serigrafía /
 Tampografía
 Capacidad: 850 ml
 Colores: B/R

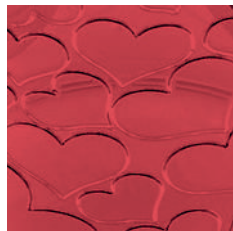
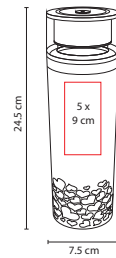

TEXTURA



B

Tapa con sistema de rosca.



A



■ ANF 010

CILINDRO MILO

Material: Plástico
 Medida: 7.7 x 25.5 cm
 Área de Impresión: 5.2 x 11.5 cm
 Técnica de Impresión: Serigrafía / Tampografía
 Capacidad: 610 ml
 Colores: A/M/N/O/P/R/V/Y
 Colores GTM: A/M/N/O/R/V

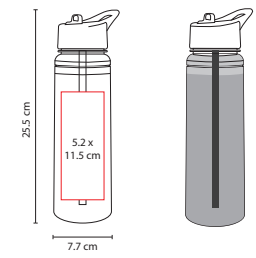

M



Y



N



R



P



V



O

Doble pared. Incluye válvula de seguridad y popote.





■ ANF 030

CILINDRO BOCINA SIRET

Material: Plástico

Medida: 7 x 25 cm

Área de Impresión: 5 x 11 cm

Técnica de Impresión: Serigrafía / Tampografía

Capacidad: 530 ml

Colores: Blanco

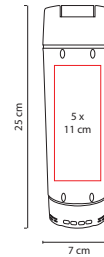

Cilindro con bocina bluetooth, controles de volumen y reproducción de audio, función manos libres, disparador de cámara al sincronizar con el smartphone. Incluye cable USB y batería recargable. Base para tablet y smartphone, bocina removible y con efectos de luces.



■ ANF 044

CILINDRO DOHA

Material: Plástico

Medida: 8.2 x 29 cm

Área de Impresión: 5.5 x 11 cm

Técnica de Impresión: Serigrafía / Tampografía

Capacidad: 600 ml

Colores: Blanco

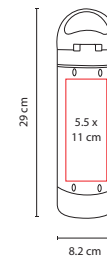

El cilindro cuenta con base para tablet y smartphone. Incluye batería auxiliar para smartphone removible, capacidad 5000 mAh. Incluye cable cargador compatible con USB y micro USB.





P



■ ANF 026

CILINDRO RELIEVE LISTÓN

Material: PET
 Medida: 7.5 x 24.5 cm
 Área de Impresión: 5 x 13 cm
 Técnica de Impresión: Serigrafía /
 Tampografía
 Capacidad: 850 ml
 Colores: A/P
 ■ Colores GTM: Rosa

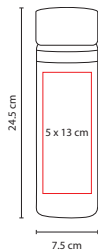

A

Tapa con sistema de rosca.

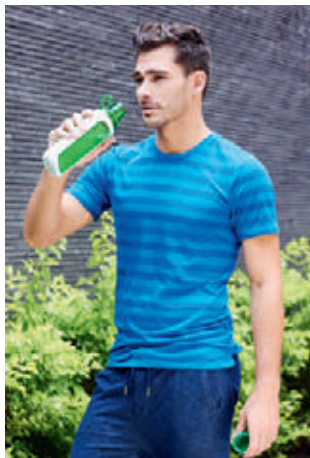

M



■ ANF 008

CILINDRO KALI

Material: Plástico Tritan
 Medida: 7.7 x 25 cm
 Área de Impresión: 4.8 x 11 cm
 Técnica de Impresión: Serigrafía / Tampografía
 Capacidad: 600 ml
 Colores: A/B/M/O/R/V
 ■ Colores GTM: A/B/R/V

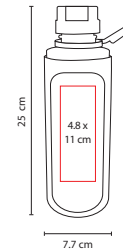

O

A

R

B

V

Tapa de rosca, con gancho de plástico incluido.



■ ANF 031

CILINDRO SHAKER OVENS

Material: Plástico

Medida: 8 x 25 cm

Área de Impresión: 5 x 10 cm

Técnica de Impresión: Serigrafía / Tampografía

Capacidad: 625 ml

Colores: A/N/O/R/V

■ Colores GTM: A/R

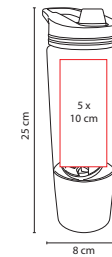

N



V



A



O



R

BEBIDAS



CILINDROS PLÁSTICOS





V



■ ANF 017

CILINDRO TISZA

Material: Plástico
Medida: 7 x 28 cm

Área de Impresión: 4.5 x 15 cm

Técnica de Impresión: Serigrafía / Tampografía

Capacidad: 800 ml

Colores: A/H/O/P/R/V

■ Colores GTM: A/H/R/V

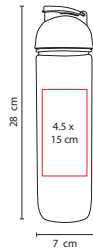

A

P

R

O

H

Cilindro con infusor para frutas o bolsas de té. Tapa con sistema de rosca.



N



■ ANF 034

CILINDRO SHAKER OLTEN

Material: PET
Medida: 7.4 x 26.3 cm

Área de Impresión: 5 x 13 cm

Técnica de Impresión: Serigrafía / Tampografía

Capacidad: 850 ml

Colores: A/N/R

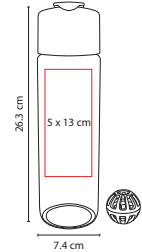

A

R

Tapa con válvula de seguridad. Incluye agitador.



V



Y



R



H



■ ANF 022

CILINDRO WESER

Material: PET

Medida: 7 x 25 cm

Área de Impresión: 5 x 10 cm

Técnica de Impresión: Serigrafía / Tampografía

Capacidad: 700 ml

Colores: A/B/H/R/V/Y Translúcidos / AS/BS/OS/RS/VS/YS Sólidos

■ ■ Colores GTM: A/B/R/V Translúcidos

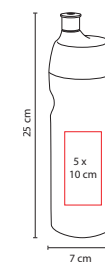

AS



ROSCA



OS



BS



VS



RS



YS



A



B





M

■ ANF 005

CILINDRO MABIRA

Material: Plástico
 Medida: 11.7 x 26.5 cm
 Área de Impresión: 7 x 14 cm
 Técnica de Impresión: Serigrafía
 Capacidad: 410 ml
 Colores: A/B/M/O/P/R/V
 Colores GTM: A/B/P/R/V

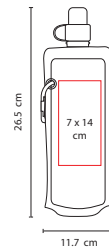

A

R

B

P

O

V

Enrollable. Incluye gancho.



O

■ ANF 029

CILINDRO SEPIK

Material: Plástico
 Medida: 8.5 x 24 cm
 Área de Impresión: 4 x 10 cm
 Técnica de Impresión: Serigrafía /
 Tampografía
 Capacidad: 800 ml
 Colores: A/O/R/V

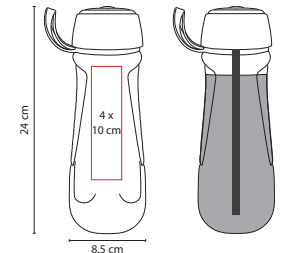

R

V

A

Incluye popote, agarradera y válvula para abrir y cerrar.



N



■ ANF 042

CILINDRO MENAFRA

Material: Plástico
 Medida: 9.5 x 24.7 cm
 Área de Impresión: 5.5 x 7.5 cm
 Técnica de Impresión: Serigrafía / Tampografía
 Capacidad: 500 ml
 Colores: A/N/R/V

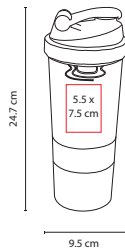

A

R

V

Incluye agitador.
 Cuenta con dos compartimentos especiales en la parte inferior y divisor de pastillas.



R



■ ANF 004

CILINDRO SHADOW

Material: PET
 Medida: 7.2 x 24.5 cm
 Área de Impresión: 4 x 8 cm
 Técnica de Impresión: Serigrafía / Tampografía
 Capacidad: 700 ml

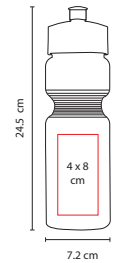

Colores: A/B/H/R/V/Y Translúcidos / Blanco Sólido
 Colores GTM: A/B/H/R/V/Y Translúcidos / Blanco Sólido



B

A

Y

V

H

BS

Tapa con válvula de seguridad.





■ ANF 039

CILINDRO CORUS

Material: Plástico / Silicón

Medida: 8 x 24 cm

Área de Impresión: 3.5 x 8 cm

Técnica de Impresión: Serigrafía / Tampografía

Capacidad: 625 ml

Colores: A/O/R/V

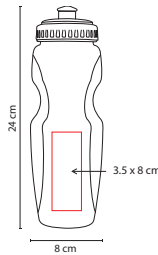

Tapa con válvula de seguridad.



■ ANF 028

CILINDRO TORRENS

Material: Plástico

Medida: 7.5 x 24.5 cm

Área de Impresión: 5 x 11 cm

Técnica de Impresión: Serigrafía / Tampografía

Capacidad: 700 ml

Colores: A/H/O/R/V

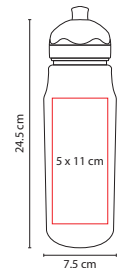

Tapa con sistema giratorio para ocultar chupón.



VS



■ ANF 045

CILINDRO PAMBOLERO LISO

Material: PET

Medida: 7.4 x 24.5 cm

Área de Impresión: 5 x 10 cm

Técnica de Impresión: Serigrafía / Tampografía

Capacidad: 750 ml

Colores: AS/BS/OS/RS/VS

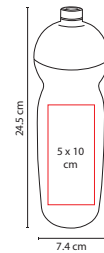

OS

AS

RS

BS

BEBIDAS



CILINDROS PLÁSTICOS



Incluye válvula de seguridad y rosca twist-off que permite abrir y cerrar la tapa en un giro.



o



■ ANF 035

CILINDRO REISA

Material: Plástico
 Medida: 9.8 x 22.8 cm
 Área de Impresión: 7 x 10 cm
 Técnica de Impresión: Tampografía
 Capacidad: 1150 ml
 Colores: A/O/R/V

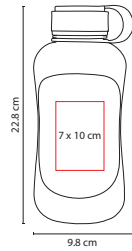

A



V



R

Tapa de rosca con agarradera.



■ ANF 038

CILINDRO ALBAY

Material: Plástico
 Medida: 12 x 20 cm
 Área de Impresión: 9.5 x 14 cm
 Técnica de Impresión: Serigrafía
 Capacidad: 500 ml
 Colores: Transparente

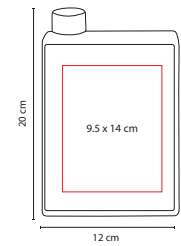

Tapa con sistema de rosca.



■ ANF 007

CILINDRO **SPRING**

Material: PET
 Medida: 7.4 x 24.5 cm
 Área de Impresión: 5 x 13 cm
 Técnica de Impresión: Serigrafía / Tampografía
 Capacidad: 850 ml
 Colores: A/H/O/P/R/V/Y Translúcidos / AS/RS/VS Sólidos
 ■ ■ Colores GTM: A/R/V

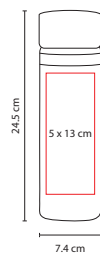

Tapa con sistema de rosca.



■ ANF 025

CILINDRO RELIEVE **PANEL**

Material: PET
 Medida: 7.5 x 24.5 cm
 Área de Impresión: 5 x 11 cm
 Técnica de Impresión: Serigrafía / Tampografía
 Capacidad: 850 ml
 Colores: A/B/R
 ■ ■ Colores GTM: A/B/R

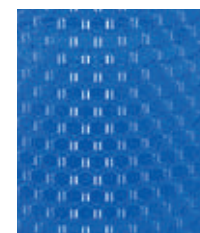
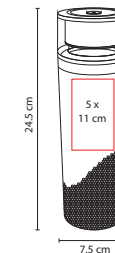

TEXTURA



Tapa con sistema de rosca.





V



■ ANF 016

CILINDRO TANDY

Material: PET
 Medida: 7,4 x 26,3 cm
 Área de Impresión: 5 x 13 cm
 Técnica de Impresión: Serigrafía / Tampografía
 Capacidad: 850 ml
 Colores: A/M/N/O/P/R/V/Y

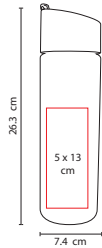

A O M P Y R N

Tapa con válvula de seguridad.



05



■ SOC 180

CILINDRO DEPORTIVO

Material: PET
 Medida: 8,7 x 24,5 cm
 Área de Impresión: 3,5 x 10 cm
 Técnica de Impresión: Serigrafía / Tampografía
 Capacidad: 700 ml
 Colores: Blanco

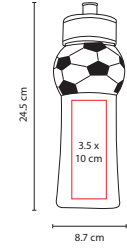

01 02 03 04 06 07

Tapa con válvula de seguridad.



R



■ ANF 013

CILINDRO BAURI

Material: PET

Medida: 6 x 17.5 cm

Área de Impresión: 5 x 10 cm

Técnica de Impresión: Serigrafía / Tampografía

Capacidad: 500 ml

Colores: A/M/N/O/R/V/Y

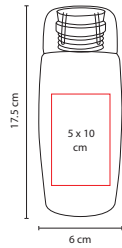

O

A

Y

N

V

M

Tapa con sistema de rosca. Cuenta con boquilla de silicón.



Y



■ ANF 012

CILINDRO EVORY

Material: PET

Medida: 6 x 20.5 cm

Área de Impresión: 5 x 10 cm

Técnica de Impresión: Serigrafía / Tampografía

Capacidad: 500 ml

Colores: A/AC/M/O/P/R/V/Y

Colores GTM: A/R/V

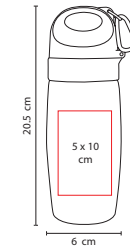

O

R

V

A

AC

P

M

Incluye gancho, botón pulsador y válvula de seguridad.





O



A

H

V

Y



ROSCA

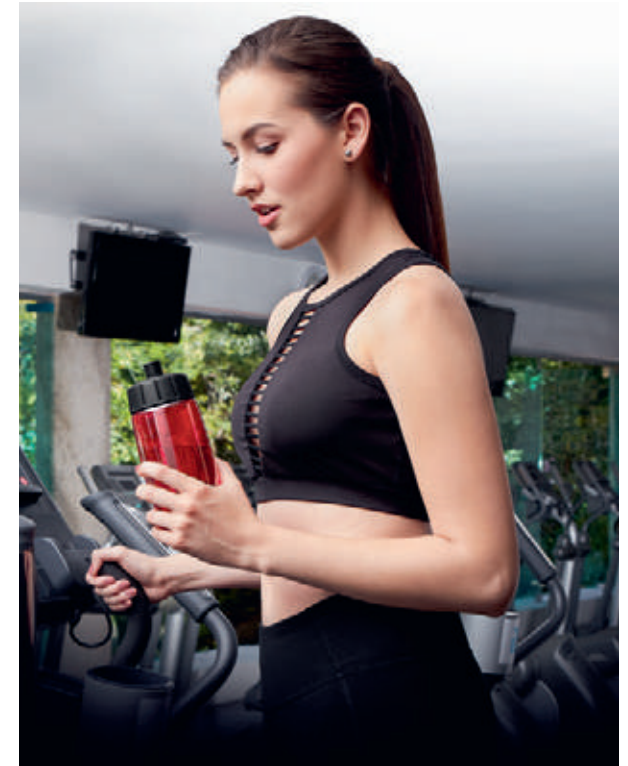

■ ANF 009

CILINDRO SINKER

Material: PET

Medida: 6 x 18.9 cm

Área de Impresión: 5 x 10 cm

Técnica de Impresión: Serigrafía / Tampografía

Capacidad: 575 ml

Colores: A/B/H/O/R/V/Y Translúcidos /
AS/BS/N/OS/RS/SS/VS/YS Sólidos

■ Colores GTM: A/B/H/O/R/V/Y Translúcidos /
AS/BS/N/OS/RS/SS/VS/YS Sólidos

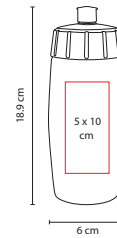

COMPARATIVO ANF 009 CON ANF 003



BS



YS



AS



N



R



B



RS



SS



OS



VS

Incluye válvula de seguridad y rosca twist-off que permite abrir y cerrar la tapa en un giro.



A



■ ANF 033

TARRO HAYLING

Material: Plástico / Aluminio
 Medida: 8.5 x 14 cm
 Área de Impresión: 5.5 x 6.5 cm
 Técnica de Impresión: Serigrafía / Tampografía
 Capacidad: 600 ml
 Colores: A/B/O/R/V



B

R

O

V

Tapa de rosca e incluye popote.



ROSCA



V



■ ANF 036

CILINDRO NAOLI

Material: PET
 Medida: 6 x 18.9 cm
 Área de Impresión: 5 x 10 cm
 Técnica de Impresión: Serigrafía / Tampografía
 Capacidad: 575 ml
 Colores: A/M/O/P/R/V

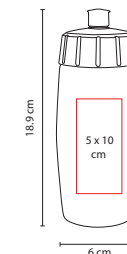

A

R

M

O

P

Incluye válvula de seguridad y rosca twist-off que permite abrir y cerrar la tapa en un giro.





ROSCA



BS



■ SOC 185

CILINDRO PAMBOLERO

Material: PET
 Medida: 7.4 x 24.5 cm
 Área de Impresión: 5 x 10 cm
 Técnica de Impresión: Serigrafía / Tampografía
 Capacidad: 750 ml
 Colores: AS/BS/RS

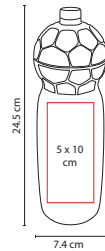

AS



RS

Incluye válvula de seguridad y rosca twist-off que permite abrir y cerrar la tapa en un giro.



H



■ ANF 032

CILINDRO ISSET

Material: Plástico
 Medida: 7.5 x 25 cm
 Área de Impresión: 4.5 x 10 cm
 Técnica de Impresión: Tampografía
 Capacidad: 625 ml
 Colores: A/H/R

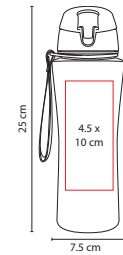

A



R

Tapa de rosca con agarradera.



■ ANF 027

CILINDRO ORIVESI

Material: Plástico
Medida: 7 x 25 cm

Área de Impresión: 5 x 10 cm

Técnica de Impresión: Serigrafía / Tampografía

Capacidad: 600 ml

Colores: A/O/P/R/V

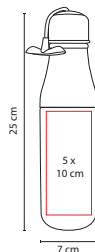

Tapa doble rosca con agarradera.



R



■ ANF 043

CILINDRO HAWARA

Material: Plástico
Medida: 8.5 x 24 cm

Área de Impresión: 6.5 x 10 cm

Técnica de Impresión: Serigrafía / Tampografía

Capacidad: 1000 ml

Colores: A/H/R

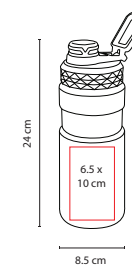

H



A

Tapa de rosca con agarradera.





CILINDROS METÁLICOS



V



■ TMPS 102

CILINDRO NUARANG

Material: Aluminio

Medida: 7.3 x 22 cm

Área de Impresión: 5.5 x 10 cm

Técnica de Impresión: Láser / Serigrafía / Tampografía

Capacidad: 700 ml

Colores: A/R/S/V

Colores GTM: A/R/S

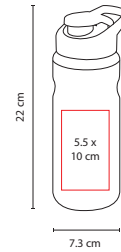

S



A



R

Incluye tapa con agarradera.



R



■ TMPS 45

CILINDRO NAVY

Material: Acero Inoxidable

Medida: 6.9 x 24.2 cm

Área de Impresión: 4.7 x 9.8 cm

Técnica de Impresión: Láser / Pantógrafo /

Serigrafía / Tampografía

Capacidad: 700 ml

Colores: A/N/R/S/V

■ Colores GTM: A/R/S

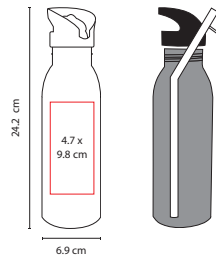

S

N

A

V

Incluye válvula de seguridad y popote.



A



■ TMPS 103

CILINDRO BANNAYA

Material: Aluminio

Medida: 7.3 x 24 cm

Área de Impresión: 5.5 x 13 cm

Técnica de Impresión: Láser / Serigrafía / Tampografía

Capacidad: 700 ml

Colores: A/G/R

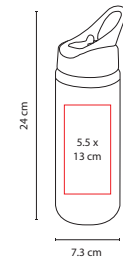

R

G

Incluye válvula de seguridad, agarradera y popote.





A



■ TMPS 101

CILINDRO INTERLAKEN

Material: Aluminio
 Medida: 7.3 x 24.5 cm
 Área de Impresión: 5.5 x 8.2 cm / 5.5 x 3.3 cm
 Técnica de Impresión: Láser / Serigrafía / Tampografía
 Capacidad: 800 ml
 Colores: A/N/R/S

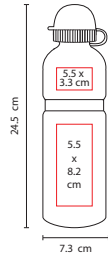

N



S



R

Incluye válvula de seguridad.



S



■ TMPS 400

MINI CILINDRO ALPES

Material: Aluminio
 Medida: 6.6 x 15.5 cm
 Área de Impresión: 4.2 x 5.8 cm
 Técnica de Impresión: Láser / Serigrafía / Tampografía
 Capacidad: 300 ml
 Colores: A/R/S

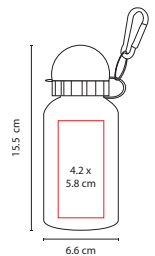

TAMAÑOS TMPS 400 Y TMPS 101



A



R

Incluye gancho y válvula de seguridad.



A



■ TMPS 61

CILINDRO LEMAN

Material: Aluminio
 Medida: 7.2 x 24 cm
 Área de Impresión: 5 x 15 cm
 Técnica de Impresión: Láser /
 Serigrafía / Tampografía
 Capacidad: 750 ml
 Colores: A/O/R/V

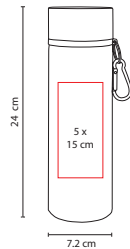

V

O

R

Tapa doble rosca con gancho.



■ TMPS 300

CILINDRO CURIEL

Material: Aluminio
 Medida: 7.3 x 24.6 cm
 Área de Impresión: 4.2 x 9 cm
 Técnica de Impresión: Láser / Serigrafía / Tampografía
 Capacidad: 500 ml
 Colores: Gris Metálico

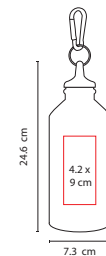

Cilindro triangular. Incluye gancho.





S



■ TMPS 60

CILINDRO MOLTON

Material: Acero Inoxidable
 Medida: 7.7 x 23 cm
 Área de Impresión: 3 x 6 cm
 Técnica de Impresión: Láser / Tampografía
 Capacidad: 650 ml
 Colores: A/N/R/S

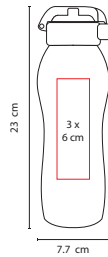

R



A



N

Incluye válvula de seguridad.



N



■ TMPS 80

CILINDRO OWEN

Material: Aluminio
 Medida: 7.3 x 28 cm
 Área de Impresión: 4.8 x 7.8 cm /
 4.8 x 3.1 cm
 Técnica de Impresión: Láser /
 Serigrafía
 Capacidad: 860 ml
 Colores: A/N/R/S/V

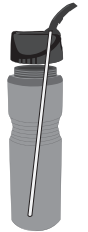
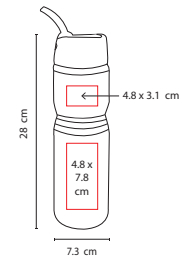

R



V



A



S

Incluye popote-gancho.



O



■ TMPS 86

CILINDRO INARI

Material: Aluminio
Medida: 7.2 x 24 cm

Área de Impresión: 5 x 14 cm

Técnica de Impresión: Láser / Serigrafía /
Tampografía

Capacidad: 750 ml

Colores: A/O/R/V

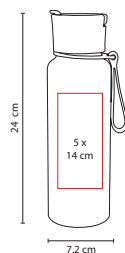

A



V



R

Incluye agarradera de silicón y válvula de seguridad.



R



■ TMPS 59

CILINDRO NEMIRA

Material: Aluminio
Medida: 7.4 x 23.5 cm

Área de Impresión: 5 x 14 cm

Técnica de Impresión: Láser / Serigrafía / Tampografía

Capacidad: 750 ml

Colores: A/O/R/V

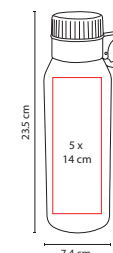

O



V



A

Tapa con sistema de rosca, agarradera y gancho.



TERMOS



R



■ TMPS 72

TERMO DABUS

Material: Plástico
Medida: 8 x 19.7 cm

Área de Impresión: 4.5 x 10 cm

Técnica de Impresión: Serigrafía / Tampografía

Capacidad: 350 ml

Colores: A/O/R

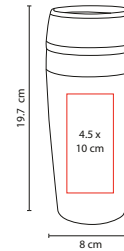

O



A



Doble pared. Con válvula especial para abrir y cerrar.





A



■ TMPS 76

VASO AOPA

Material: Plástico
Medida: 8.8 x 19.7 cm
Área de Impresión: 6 x 7 cm
Técnica de Impresión: Serigrafía / Tampografía
Capacidad: 600 ml
Colores: A/O/R/V

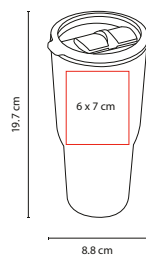

R



V



O

Doble pared. Incluye válvula de seguridad.



R



■ TT 09

TERMO NOVA

Material: Plástico
Medida: 6 x 18 cm
Área de Impresión: 5 x 7 cm
Técnica de Impresión: Serigrafía / Tampografía
Capacidad: 450 ml
Colores: A/N/R/V/Y

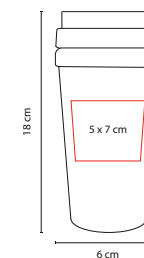

N



Y



V



A

Incluye válvula de seguridad.





B



■ TMPS 39

TERMO CLOVELLY

Material: Acero Inoxidable / Plástico
 Medida: 7.5 x 14.5 cm
 Área de Impresión: 4.5 x 7 cm
 Técnica de Impresión: Serigrafía / Tampografía
 Capacidad: 250 ml
 Colores: A/B/O/R/V

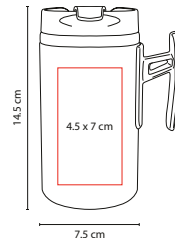

O

R

A

V

Doble pared. Incluye válvula de seguridad.



P



■ TMPS 53

TERMO LOVAT

Material: Plástico
 Medida: 8 x 21.5 cm
 Área de Impresión: 4.5 x 11 cm
 Técnica de Impresión: Serigrafía / Tampografía
 Capacidad: 400 ml
 Colores: A/O/P/R/V

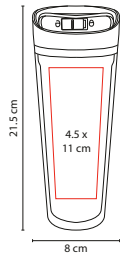

V

R

A

O

Doble pared. Válvula con seguro para abrir y cerrar.



V



■ TMPS 11

TERMO SPACE

Material: Plástico
 Medida: 8.5 x 20 cm
 Área de Impresión: 4.2 x 10.5 cm
 Técnica de Impresión: Serigrafía / Tampografía
 Capacidad: 530 ml
 Colores: A/B/N/O/R/V

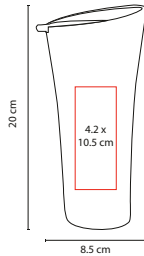

A



B



N



O



R

Doble pared. Con tapa de presión e interior en color negro.



A



■ TMPS 12

TERMO KASAI

Material: Plástico
 Medida: 6.5 x 20 cm
 Área de Impresión: 4 x 10 cm
 Técnica de Impresión: Serigrafía / Tampografía
 Capacidad: 350 ml
 Colores: A/O/R/V
 ■ ■ Colores GTM: A/O/R/V

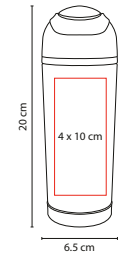

O



R



V

Doble pared. Tapa de rosca con agarradera.





A



■ TMPS 73

VASO HOWTH

Material: Plástico
 Medida: 9.5 x 20 cm
 Área de Impresión: 5.5 x 7.3 cm
 Técnica de Impresión: Serigrafía / Tampografía
 Capacidad: 500 ml
 Colores: A/H/O/R/V

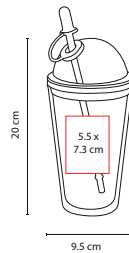

V

R

H

O

Doble pared. Popote incluido.



R



■ TT 02

TERMO LANE

Material: Plástico
 Medida: 8.1 x 17.4 cm
 Área de Impresión: 5 x 8 cm
 Técnica de Impresión: Serigrafía / Tampografía
 Capacidad: 400 ml
 Colores: A/G/R/V/Y
 Colores GTM: A/G/R/V/Y

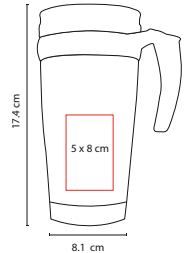

V

A

Y

G

Doble pared. Interior térmico. Incluye válvula de seguridad.



V



■ TMPS 42

TERMO NYUK

Material: Acero Inoxidable / Plástico
 Medida: 6.5 x 16 cm
 Área de Impresión: 4 x 8 cm
 Técnica de Impresión: Láser / Pantógrafo /
 Serigrafía / Tampografía
 Capacidad: 325 ml
 Colores: A/B/N/R/V

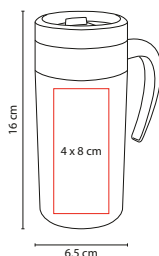

N

A

R

B

Doble pared. Incluye válvula de seguridad.



A



■ TMPS 13

TERMO SKY

Material: Plástico
 Medida: 8.1 x 20.7 cm
 Área de Impresión: 4.5 x 9.3 cm
 Técnica de Impresión: Serigrafía / Tampografía
 Capacidad: 450 ml
 Colores: A/N/O/R/V/Y

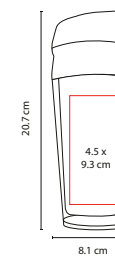

N

R

V

Y

O

Doble pared. Con válvula especial para abrir y cerrar.





R



■ TMPS 31

TERMO BAKU

Material: Acero Inoxidable / Plástico
 Medida: 8.7 x 18.1 cm
 Área de Impresión: 4.3 x 4.8 cm
 Técnica de Impresión: Serigrafía / Tampografía
 Capacidad: 425 ml
 Colores: A/O/R
 Colores GTM: A/R

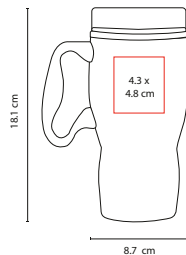

A

O

Doble pared. Incluye válvula de seguridad.



A



■ TMPS 55

TERMO LUGANO

Material: Plástico
 Medida: 8.1 x 22 cm
 Área de Impresión: 4 x 10.5 cm
 Técnica de Impresión: Serigrafía / Tampografía
 Capacidad: 375 ml
 Colores: A/O/R/V
 Colores GTM: A/R/V

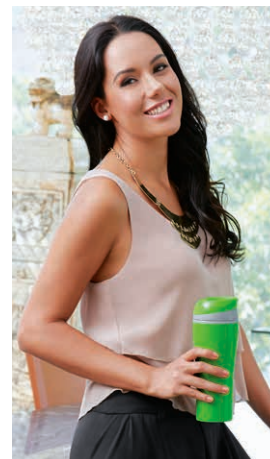
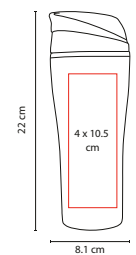

V

O

R

Doble pared. Tapa deslizable con válvula de seguridad.



O



■ TMPS 36

TERMO VITALI

Material: Plástico / Acero Inoxidable

Medida: 8.7 x 22 cm

Área de Impresión: 5 x 13 cm

Técnica de Impresión: Serigrafía / Tampografía

Capacidad: 425 ml

Colores: A/O/R/V

■ Colores GTM: A/R/V

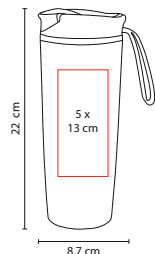

Doble pared con agarradera de silicón. Incluye chupón de succión que permite la fijación a la superficie evitando el derrame por accidente. Incluye válvula de seguridad.



V



■ TMPS 96

TERMO EZIK

Material: Acero Inoxidable / Plástico

Medida: 7 x 25.5 cm

Área de Impresión: 5 x 11 cm

Técnica de Impresión: Pantógrafo /

Láser / Serigrafía / Tampografía

Capacidad: 475 ml

Colores: A/O/V

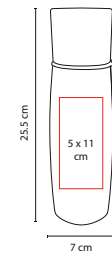

A

O

Doble pared. Incluye válvula de seguridad, vaso en tapa y agarradera de silicón.





R



■ TMPS 58

TERMO VICARE

Material: Acero Inoxidable / Plástico
 Medida: 8.4 x 21 cm
 Área de Impresión: 6 x 7 cm
 Técnica de Impresión: Láser / Serigrafía / Tampografía
 Capacidad: 450 ml
 Colores: A/O/R/V

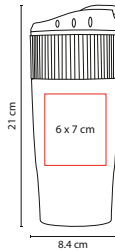

O



A



V

Doble pared. Incluye válvula de seguridad y banda de silicón.



A



■ TMPS 57

TERMO LIPOVEI

Material: Acero Inoxidable / Plástico
 Medida: 7.6 x 25 cm
 Área de Impresión: 5 x 14 cm
 Técnica de Impresión: Láser / Serigrafía / Tampografía
 Capacidad: 450 ml
 Colores: A/B/R

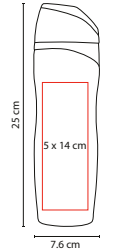

R



B

Doble pared. Cerrado al vacío, incluye botón pulsador para abrir y cerrar.



B



■ TMPS 46

TERMO EYRE

Material: Acero Inoxidable / Plástico

Medida: 7.3 x 21.3 cm

Área de Impresión: 4 x 9 cm

Técnica de Impresión: Pantógrafo / Serigrafía /

Láser / Tampografía

Capacidad: 370 ml

Colores: A/B/R

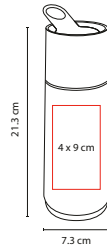

R

A

Doble pared. Cuenta con compartimento especial oculto en la base para guardar cosas pequeñas.



A



■ TMPS 95

TERMO SYBARI

Material: Acero Inoxidable / Plástico

Medida: 7 x 20 cm

Área de Impresión: 4.5 x 7 cm

Técnica de Impresión: Láser / Serigrafía / Tampografía

Capacidad: 425 ml

Colores: A/R

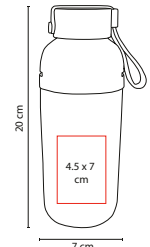

R

Doble pared con agarradera de silicona. Interior metálico removible para grabado.





A



■ TMPS 54

TERMO WIGLEK

Material: Acero Inoxidable / Plástico
 Medida: 7 x 20 cm
 Área de Impresión: 5 x 9 cm
 Técnica de Impresión: Láser / Serigrafía / Tampografía
 Capacidad: 260 ml
 Colores: A/G/R

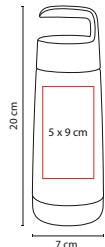

R



■ TMPS 97

TERMO MURRAY

Material: Acero Inoxidable / Plástico
 Medida: 6.5 x 22 cm
 Área de Impresión: 4.5 x 5 cm
 Técnica de Impresión: Serigrafía / Tampografía
 Capacidad: 230 ml
 Colores: A/N/R

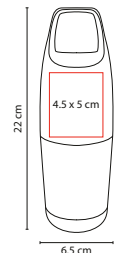

G



R



A



N

Doble pared. Cerrado al vacío y tapa con agarradera.

Doble pared. Cerrado al vacío. Con agarradera.



G



■ TMPS 47

TERMO AREUSE

Material: Acero Inoxidable / Plástico

Medida: 7.2 x 21.8 cm

Área de Impresión: 6 X 4.5 cm

Técnica de Impresión: Láser / Serigrafía / Tampografía

Capacidad: 450 ml

Colores: A/G/R

■ Colores GTM: A/G/R

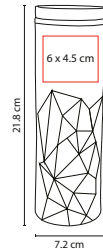

R



A

Doble pared. Cuerpo prismático. Incluye válvula de seguridad.



T



■ TMPS 23

TERMO BANGKOK

Material: Acero Inoxidable / Plástico

Medida: 7.7 x 21.5 cm

Área de Impresión: 4.3 x 9 cm

Técnica de Impresión: Serigrafía / Tampografía

Capacidad: 480 ml

Colores: A/N/R/T

■ Colores GTM: A/R/T

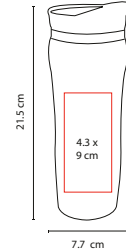

N



R



A

Doble pared. Incluye válvula de seguridad.





R



■ TMPS 17

TERMO LIBERTY

Material: Acero Inoxidable / Plástico
 Medida: 8.8 x 15.3 cm
 Área de Impresión: 5.2 x 4.7 cm
 Técnica de Impresión: Serigrafía / Tampografía
 Capacidad: 450 ml
 Colores: A/R/T
 Colores GTM: A/R/T

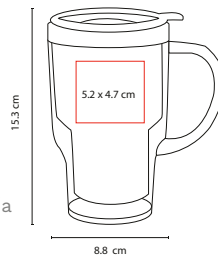

A



T

Doble pared. Cubierta translúcida.



T



■ TMPS 18

TERMO HEAT CON USB

Material: Acero Inoxidable / Plástico
 Medida: 8.7 x 19.9 cm
 Área de Impresión: 5.2 x 5.2 cm Plástico /
 4 x 4.6 cm Metal
 Técnica de Impresión: Serigrafía /
 Tampografía
 Capacidad: 350 ml
 Colores: A/R/T
 Colores GTM: A/R

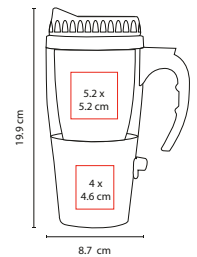

A



R

Doble pared. Fuente corriente, adaptador para automóvil y USB, mantiene la temperatura de las bebidas, no calienta. Incluye válvula de seguridad.



V



■ TMPS 71

TERMO OSAKA

Material: Acero Inoxidable / Plástico

Medida: 7.5 x 18.2 cm

Área de Impresión: 4.5 x 6 cm
Técnica de Impresión: Pantógrafo /
Láser / Serigrafía / Tampografía

Capacidad: 400 ml

Colores: A/R/V

Colores GTM: A/R

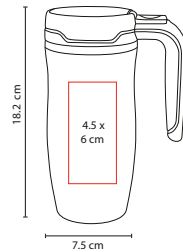

■ TMPS 77

TERMO YUKSHIN

Material: Acero Inoxidable / Plástico

Medida: 8.7 x 17.7 cm

Área de Impresión: 6 x 12 cm
Técnica de Impresión: Pantógrafo /
Serigrafía / Tampografía

Capacidad: 550 ml

Colores: Plata

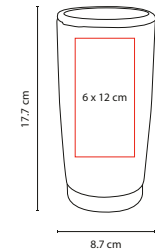

A



R

Doble pared. Incluye botón pulsador para abrir y cerrar.



Doble pared. Cerrado al vacío.





■ TMPS 62

TERMO YANGRA

Material: Acero Inoxidable / Plástico

Medida: 10 x 20.3 cm

Área de Impresión: 7.5 x 7.5 cm

Técnica de Impresión: Pantógrafo /

Serigrafía / Tampografía

Capacidad: 850 ml

Colores: Plata

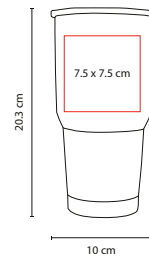

Doble pared. Cerrado al vacío.



■ TMPS 56

TERMO ONEGA

Material: Plástico

Medida: 8.3 x 15.5 cm

Área de Impresión: 7 x 8 cm

Técnica de Impresión: Sublimación /

Serigrafía / Tampografía

Capacidad: 450 ml

Colores: Blanco

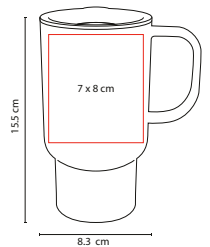

Doble pared. Termo para sublimar. Incluye válvula de seguridad.



■ TMPS 52

TERMO ONELA

Material: Acero Inoxidable / Plástico
Medida: 9.5 x 18.3 cm
Área de Impresión: 6 x 10 cm
Técnica de Impresión: Pantógrafo /
Láser / Serigrafía / Tampografía
Capacidad: 475 ml
Colores: Plata

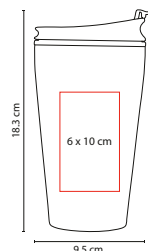

Doble pared. Incluye válvula de seguridad.



R



■ TMPS 64

TERMO BROADPEAK

Material: Acero Inoxidable / Plástico
Medida: 9 x 17 cm
Área de Impresión: 6.5 x 11 cm
Técnica de Impresión: Láser /
Serigrafía / Tampografía
Capacidad: 540 ml
Colores: A/R/S
■ ■ Colores GTM: Plata

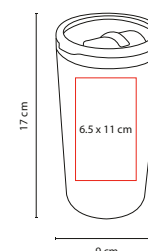

A



S

Doble pared. Incluye válvula de seguridad.





N



■ TMPS 49

TERMO ALLALIN

Material: Acero Inoxidable / Plástico

Medida: 9.3 x 19 cm

Área de Impresión: 7 x 5 cm

Técnica de Impresión: Láser /

Serigrafía / Tampografía

Capacidad: 525 ml

Colores: B/N/S

■ ■ Colores GTM: B/N/S

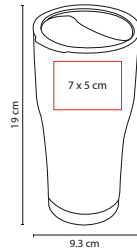

B



S

Doble pared. Cerrado al vacío.



■ TMPS 83

TERMO PIXYS

Material: Acero Inoxidable / Plástico

Medida: 6.9 x 24.5 cm

Área de Impresión: 4.5 x 12 cm

Técnica de Impresión: Serigrafía / Tampografía

Capacidad: 450 ml

Colores: Plata

■ ■ Colores GTM: Plata

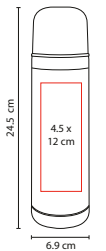

Doble pared. Incluye válvula de seguridad.



■ TMPS 68

TERMO AKAN

Material: Acero Inoxidable / Plástico
Medida: 7.3 x 28.2 cm
Área de Impresión: 5.5 x 14 cm
Técnica de Impresión: Pantógrafo /
Serigrafía / Tampografía
Capacidad: 600 ml
Colores: Plata

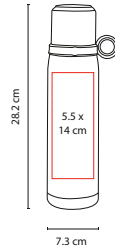

Doble pared. Cerrado al vacío. Incluye taza con agarradera y válvula de seguridad.



■ TMPS 63

TERMO CHONGTAR

Material: Acero Inoxidable / Plástico
Medida: 7 x 21.5 cm
Área de Impresión: 6 x 10 cm
Técnica de Impresión: Pantógrafo /
Serigrafía / Tampografía
Capacidad: 450 ml
Colores: Plata
■ ■ Colores GTM: Plata

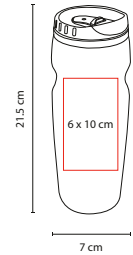

Doble pared. Incluye válvula de seguridad.





■ TMF 07

TERMO CON PAPEL EASY-PRINT

Material: Acero Inoxidable / Plástico
 Medida: 8.7 x 17.5 cm
 Área de Impresión: 29 x 9 cm
 Técnica de Impresión: Pantógrafo / Serigrafía
 Capacidad: 630 ml
 Colores: Plata con Plástico Transparente

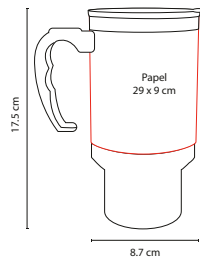

Doble pared. Incluye papel para impresión.



■ TMPS 16

TERMO TRAVEL MUG

Material: Acero Inoxidable / Plástico
 Medida: 8.6 x 14.7 cm
 Área de Impresión: 5.3 x 5.7 cm
 Técnica de Impresión: Pantógrafo / Serigrafía / Láser / Tampografía
 Capacidad: 450 ml
 Colores: Plata

Colores GTM: Plata

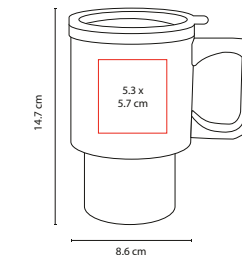

Doble pared. Incluye válvula de seguridad.



■ TMPS 43

TERMO FIESCHER

Material: Acero Inoxidable / Plástico
 Medida: 9 x 16.5 cm
 Área de Impresión: 6.5 x 6.5 cm
 Técnica de Impresión: Pantógrafo / Serigrafía / Láser / Tampografía
 Capacidad: 450 ml
 Colores: Plata

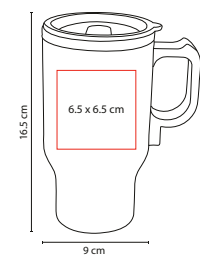

Doble pared. Fuente corriente, adaptador para automóvil y USB, mantiene la temperatura de las bebidas, no calienta. Incluye válvula de seguridad.



■ KTC 029

JARRA VIANA

Material: Plástico
Medida: 14 x 25 cm
Área de Impresión: 6 x 12 cm
Técnica de Impresión: Serigrafía
Capacidad: 1 Litro
Colores: Blanco

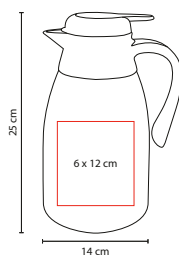

Jarra térmica.



■ TMPS 78

TERMO DELMORE

Material: Acero Inoxidable / Plástico
Medida: 9 x 19.5 cm
Área de Impresión: 7 x 8 cm
Técnica de Impresión: Pantógrafo / Serigrafía / Tampografía
Capacidad: 575 ml
Colores: Plata
Colores GTM: Plata

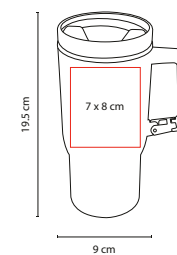

Doble pared. Incluye asa con carabina.





TMPS 14

TERMO KALAU

Material: Acero Inoxidable / Plástico
 Medida: 8.5 x 17 cm
 Área de Impresión: 5 x 8 cm
 Técnica de Impresión: Pantógrafo /
 Láser / Serigrafía / Tampografía
 Capacidad: 400 ml
 Colores: Plata
 Colores GTM: Plata

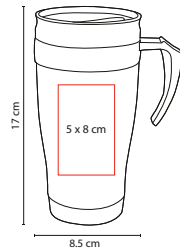

Doble pared. Incluye válvula de seguridad.



TMPS 30

TERMO THUNDER

Material: Acero Inoxidable / Plástico
 Medida: 8.7 x 18.1 cm
 Área de Impresión: 4.3 x 4.8 cm
 Técnica de Impresión: Pantógrafo /
 Láser / Serigrafía / Tampografía
 Capacidad: 425 ml
 Colores: Plata
 Colores GTM: Plata

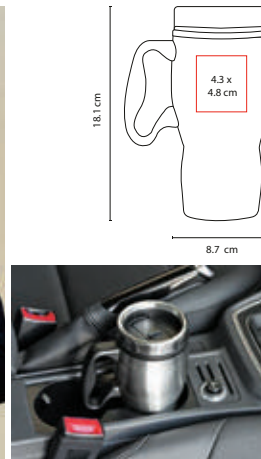

Doble pared. Incluye válvula de seguridad.



TMPS 19

TERMO TURBO COFFEE

Material: Acero Inoxidable / Plástico
 Medida: 8.5 x 18.2 cm
 Área de Impresión: 6 x 3.7 cm
 Técnica de Impresión: Pantógrafo /
 Láser / Serigrafía / Tampografía
 Capacidad: 425 ml
 Colores: Plata
 Colores GTM: Plata

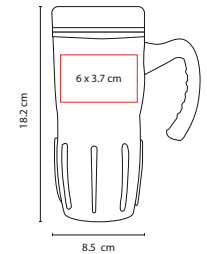

Doble pared. Con barras antiderrapantes y válvula de seguridad.



SISTEMA DE SUCCIÓN



■ TMPS 66

TERMO ADEN

Material: Acero Inoxidable / Plástico

Medida: 8.5 x 19 cm

Área de Impresión: 6 x 4 cm

Técnica de Impresión: Pantógrafo /

Serigrafía / Tampografía

Capacidad: 375 ml

Colores: Plata

■ ■ Colores GTM: Plata

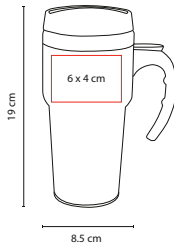

Doble pared. Cerrado al vacío. Incluye chupón de succión que permite la fijación a la superficie evitando el derrame por accidente. Incluye válvula de seguridad.



■ TMPS 67

TERMO ANKARA

Material: Acero Inoxidable / Plástico

Medida: 8 x 22.8 cm

Área de Impresión: 5.5 x 14 cm

Técnica de Impresión: Pantógrafo /

Serigrafía / Tampografía

Capacidad: 525 ml

Colores: Plata

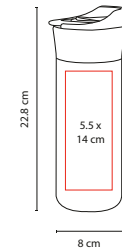

Doble pared. Incluye válvula de seguridad.





■ TMPS 87

TERMO KUMASI

Material: Acero Inoxidable / Plástico
 Medida: 8.5 x 24.2 cm
 Área de Impresión: 4.5 x 13 cm
 Técnica de Impresión: Láser /
 Serigrafía / Tampografía
 Capacidad: 525 ml
 Colores: Gris Oxford Metalizado

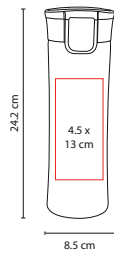

Doble pared. La tapa incluye botón pulsador para abrir y cerrar con sistema desmontable.
 Cerrado al vacío.



■ TMPS 38

TERMO MADISON

Material: Acero Inoxidable / Plástico
 Medida: 7 x 20.2 cm
 Área de Impresión: 4 x 8 cm
 Técnica de Impresión: Pantógrafo /
 Láser / Serigrafía / Tampografía
 Capacidad: 325 ml
 Colores: Gris Oxford Metalizado

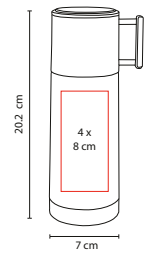

Doble pared. Cerrado al vacío. Incluye taza y válvula de seguridad.



■ TMPS 51

TERMO KOFI

Material: Acero Inoxidable / Plástico
 Medida: 12 x 23 cm
 Área de Impresión: 6 x 4 cm
 Técnica de Impresión: Pantógrafo /
 Serigrafía / Tampografía
 Capacidad: 950 ml
 Colores: Negro

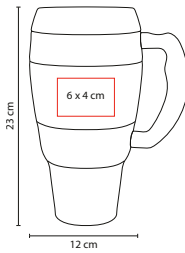

Doble pared. Incluye válvula de seguridad.



■ TMPS 29

TERMO ARES

Material: Acero Inoxidable / Plástico
 Medida: 9.2 x 21.5 cm
 Área de Impresión: 6.5 x 4.5 cm
 Técnica de Impresión: Pantógrafo /
 Láser / Serigrafía / Tampografía
 Capacidad: 740 ml
 Colores: Plata

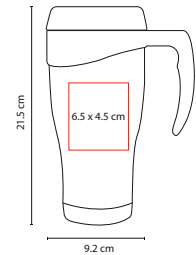

Doble pared. Incluye válvula de seguridad.





■ TMPS 105

TERMO NUUR

Material: Plástico
 Medida: 15 x 26.5 cm
 Área de Impresión: 8 x 9 cm
 Técnica de Impresión: Serigrafía / Tampografía
 Capacidad: 1900 ml
 Colores: Gris

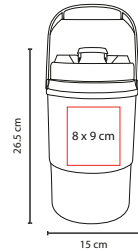

Doble pared. Incluye válvula de seguridad y agarradera.



■ TMPS 15

TERMO DUBLÍN

Material: Acero Inoxidable
 Medida: 7.7 x 28.8 cm
 Área de Impresión: 3.9 x 9.7 cm
 Técnica de Impresión: Pantógrafo /
 Láser / Serigrafía
 Capacidad: 600 ml
 Colores: Plata
 Colores GTM: Plata

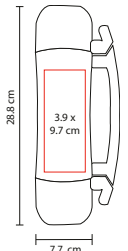

Doble pared. Asa de plástico. Incluye dos tazas metálicas.



O

■ TMPS 74

VASO TIRICH

Material: Plástico
Medida: 9 x 16 cm

Área de Impresión: 5 x 8 cm

Técnica de Impresión: Serigrafía / Tampografía

Capacidad: 475 ml

Colores: A/B/N/O/R/V/Y

Colores GTM: A/B/R

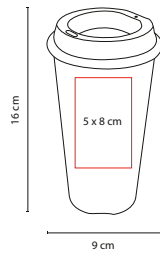

A



R



B



Y



V



N

Incluye tapa.



V

■ TMPS 24

VASO EMBASSY

Material: Plástico
Medida: 9.2 x 16 cm

Área de Impresión: 5.5 x 7.3 cm

Técnica de Impresión: Serigrafía / Tampografía

Capacidad: 500 ml

Colores: A/B/O/R/V

Colores GTM: A/B/R

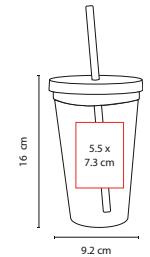

A



R



B



O

Doble pared. Popote incluido.





A



■ TMPS 48

VASO NERIS

Material: Plástico
 Medida: 9.5 x 18.5 cm
 Área de Impresión: 4.5 x 9 cm
 Técnica de Impresión: Serigrafía / Tampografía
 Capacidad: 475 ml
 Colores: A/B/R

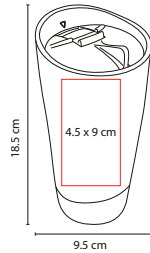

R



B

Incluye válvula de seguridad.



R



■ TMPS 27

VASO LOGAM

Material: Plástico
 Medida: 7.5 x 20 cm
 Área de Impresión: 6 x 10 cm
 Técnica de Impresión: Serigrafía / Tampografía
 Capacidad: 500 ml
 Colores: A/B/M/O/R/V
 Colores GTM: A/B/R

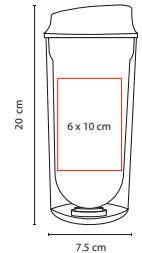

O



M



V



A



B

Doble pared. Incluye válvula de seguridad.



A



■ TMPS 22

VASO ARGENS

Material: Plástico / Silicón
Medida: 8.5 x 16.2 cm

Área de Impresión: 5 x 7 cm

Técnica de Impresión: Serigrafía / Tampografía

Capacidad: 350 ml

Colores: A/N/O/P/R/V

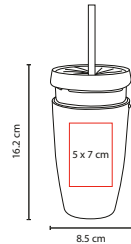

R

N

O

V

P

Doble pared. Cuenta con sistema giratorio para abrir y cerrar la cubierta de silicón. Incluye popote.



V



■ TMPS 21

VASO DEVERON

Material: Plástico / Silicón
Medida: 8.5 x 16.2 cm

Área de Impresión: 5 x 3 cm

Técnica de Impresión: Serigrafía / Tampografía

Capacidad: 480 ml

Colores: A/C/V

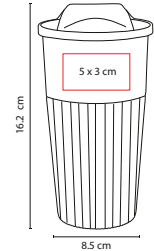

C



A

Incluye válvula de seguridad y protector de silicón.





R



■ TMPS 37

VASO LIA

Material: Plástico
 Medida: 9.5 x 27 cm
 Área de Impresión: 5 x 10 cm
 Técnica de Impresión: Serigrafía / Tampografía
 Capacidad: 450 ml
 Colores: O/R/V

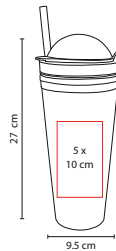

V

O

Compartimento superior para alimentos y botana.
 Doble pared. Incluye popote.



Y



■ TAZ 007

VASO VENETTA

Material: Cerámica / Silicón
 Medida: 8.7 x 17.5 cm
 Área de Impresión: 5.2 x 4.8 cm
 Técnica de Impresión: Serigrafía / Tampografía
 Capacidad: 410 ml
 Colores: A/N/O/R/Y

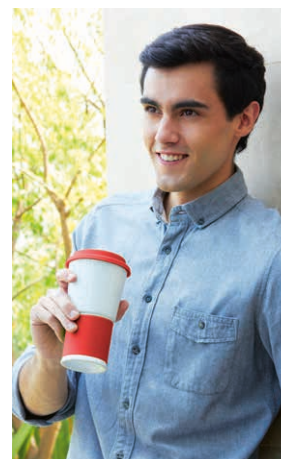
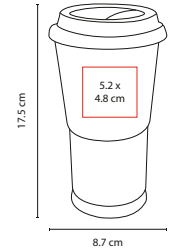

A

R

N

O

Vaso de pared sencilla con recubrimiento y tapa de silicón.
 No usar en microondas ni lavavajillas. Venta individual.

TAZAS



BEBIDAS



TAZAS



■ TAZ 026

TAZA RIMO

Material: Cerámica
Medida: 9 x 10.2 cm

Área de Impresión: 6 x 6 cm

Técnica de Impresión: Grabado en Arena /
Serigrafía / Termocalca

Capacidad: 13 Oz

Colores: A/N/O/R/V

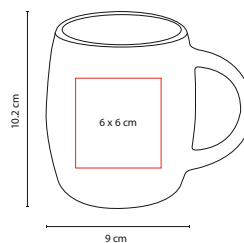

A



O



N



V



R

Venta individual.



■ TAZA 025

TAZA ANZAC

Material: Cerámica

Medida: 10 x 11 cm

Área de Impresión: 6.5 x 6.5 cm

Técnica de Impresión: Grabado en Arena /

Serigrafía / Tampografía

Capacidad: 16 Oz

Colores: Blanco

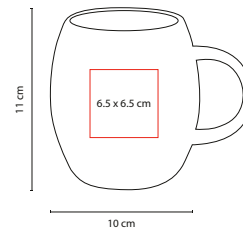

SISTEMA DE SUCCIÓN



Incluye chupón de succión que permite la fijación a la superficie evitando el derrame por accidente.
No usar en microondas ni lavavajillas. Incluye caja de regalo. Venta individual.



■ TAZ 029

SET DE TAZAS IWAO

Material: Cerámica / Bambú

Medida: 20 x 13 cm

Área de Impresión: 3.5 x 3.5 cm Taza /
15 x 2 cm Base

Técnica de Impresión: Láser / Serigrafía

Capacidad: 8 Oz

Colores: Blanco

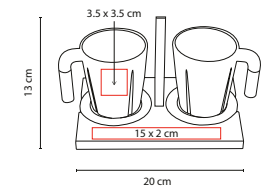

Incluye dos tazas, dos porta tazas de bambú y caja de regalo. No usar en microondas ni lavavajillas.



G



■ TAZ 028

TAZA MORTERATSCH

Material: Porcelana

Medida: 9 x 9.5 cm

Área de Impresión: 6 x 6 cm

Técnica de Impresión: Grabado en Arena / Serigrafía / Termocalca

Capacidad: 13 Oz

Colores: B/G/N

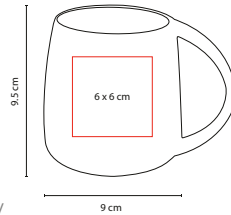

N



B

Venta individual.



■ TAZ 015

TAZA FRISIA

Material: Cerámica

Medida: 8 x 9.6 cm

Área de Impresión: 5.5 x 5.5 cm

Técnica de Impresión: Sublimación / Serigrafía / Grabado en Arena / Termocalca

Capacidad: 11 Oz

Colores: Blanco

Colores GTM: Blanco

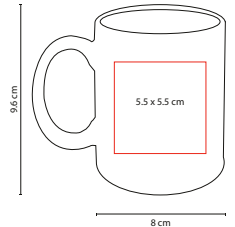

Taza para sublimar. Venta caja cerrada de 36 piezas.



SISTEMA DE SUCCIÓN



■ TAZ 030

TAZA JANNU

Material: Plástico / Acero Inoxidable

Medida: 9.2 x 14.2 cm

Área de Impresión: 6 x 6 cm

Técnica de Impresión: Serigrafía /

Tampografía

Capacidad: 13 Oz

Colores: Gris con Blanco

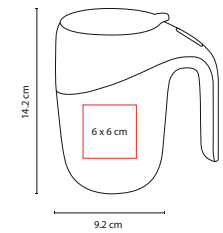

Doble pared. Incluye tapa y chupón de succión que permite la fijación a la superficie evitando el derrame por accidente.





A



■ TAZ 014

TAZA BOGATI

Material: Porcelana
Medida: 6 x 11 cm

Área de Impresión: 5 x 4 cm

Técnica de Impresión: Serigrafía / Tampografía

Capacidad: 10 Oz

Colores: A/Y

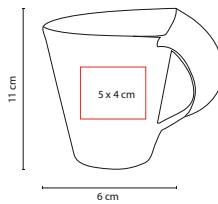

Y

Venta individual.



V



■ TAZ 019

TAZA KABBI

Material: Cerámica
Medida: 8 x 9.5 cm

Área de Impresión: 5.5 x 5.5 cm

Técnica de Impresión: Serigrafía

Capacidad: 11 Oz

Colores: A/O/P/R/V/Y

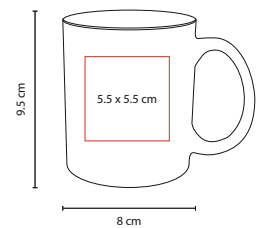

O



P



R



A



Y

Taza con terminado neón. Venta caja cerrada de 36 piezas.



V



■ TAZ 003

TAZA VERONA

Material: Cerámica
Medida: 8 x 9.4 cm

Área de Impresión: 5.3 x 5.9 cm

Técnica de Impresión: Grabado en Arena /
Serigrafía / Termocalca

Capacidad: 11 Oz

Colores: A/N/R/V/Y

Colores GTM: N/R/Y

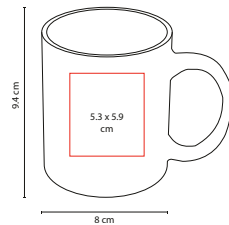

Y



N



A



R

Venta caja cerrada de 36 piezas.



G



■ TAZ 032

TAZA AMPAT

Material: Cerámica
Medida: 8 x 12 cm

Área de Impresión: 5 x 5 cm

Técnica de Impresión: Grabado en Arena /
Serigrafía / Termocalca

Capacidad: 13 Oz

Colores: A/G/O/R/V

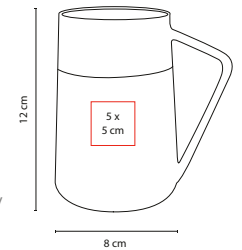

R



V



A



O

Incluye caja de regalo. Venta individual.





A



■ TAZA 023

TAZA NORTIA

Material: Porcelana
Medida: 9.3 x 10 cm

Área de Impresión: 6 x 6 cm

Técnica de Impresión: Grabado en Arena / Serigrafía / Tampografía / Termocalca

Capacidad: 14 Oz
Colores: A/B/G/R

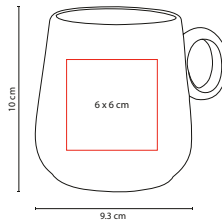

Incluye caja de regalo. Venta individual.



V



■ TAZA 021

TAZA ANNECY

Material: Cerámica / Silicón
Medida: 9.3 x 11.5 cm

Área de Impresión: 6.5 x 6.5 cm

Técnica de Impresión: Grabado en Arena / Serigrafía / Termocalca

Capacidad: 17 Oz
Colores: A/O/R/V

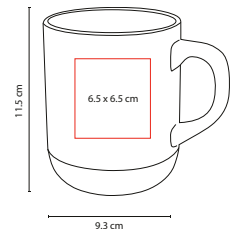

Cuenta con base de silicón. Venta individual.



A



TAZ 002

TAZA DOLCE

Material: Cerámica
 Medida: 8.6 x 11.6 cm
 Área de Impresión: 5.2 x 6.6 cm
 Técnica de Impresión: Grabado en Arena /
 Serigrafía / Termocalca
 Capacidad: 15 Oz
 Colores: A/N/R/V/Y
 Colores GTM: R/Y

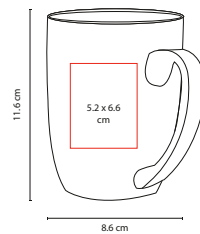

Y



TAZ 022

TAZA COLORÉ

Material: Cerámica
 Medida: 8 x 9.6 cm
 Área de Impresión: 5.5 x 5.5 cm
 Técnica de Impresión: Láser /
 Serigrafía
 Capacidad: 11 Oz
 Colores: A/N/O/R/V/Y

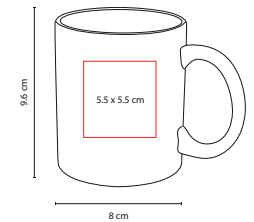

V



N



R



Y

Venta caja cerrada de 36 piezas.



N



O



A



V



R

Taza con recubrimiento interior de color para resaltar el logo una vez aplicado el grabado láser.
 Venta caja cerrada de 36 piezas.





R



■ TAZ 010

TAZA MARSELLA

Material: Cerámica / Silicón

Medida: 8.2 x 12.2 cm

Área de Impresión: 3.7 x 5.3 cm

Técnica de Impresión: Grabado en Arena /

Serigrafía / Termocalca

Capacidad: 11 Oz

Colores: A/N/R

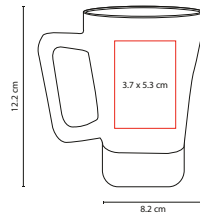

A



N



N



■ TAZ 005

TAZA MOFFY

Material: Cerámica

Medida: 8.3 x 10.3 cm

Área de Impresión: 5.6 x 5.9 cm

Técnica de Impresión: Grabado en Arena /

Serigrafía / Termocalca

Capacidad: 11 Oz

Colores: A/N/R

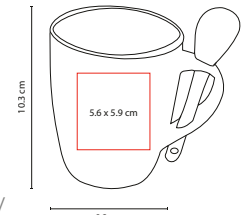

A



R

Cuenta con base de silicón. Venta individual.

Incluye cuchara. Venta caja cerrada de 36 piezas.



A



■ TAZA 012

TAZA TAURÉ

Material: Porcelana / Acero Inoxidable
 Medida: 9 x 10.3 cm
 Área de Impresión: 6.5 x 4 cm Porcelana /
 4 x 1.5 cm Metal
 Técnica de Impresión: Láser /
 Pantógrafo / Tampografía
 Capacidad: 12 Oz
 Colores: A/R/S

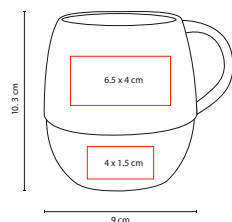

S



R

Incluye caja de regalo. No usar en microondas ni lavavajillas. Venta individual.



O



■ TAZA 027

TAZA GILLEN

Material: Cerámica / Silicón
 Medida: 8.5 x 15.2 cm
 Área de Impresión: 6 x 9 cm
 Técnica de Impresión: Grabado en Arena /
 Serigrafía / Termocalca
 Capacidad: 17 Oz
 Colores: A/G/O/R/V

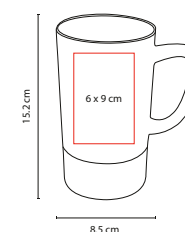

R



V



G



A

Cuenta con base de silicón. Venta individual.





■ TAZ 018

TAZA ATBARA

Material: Plástico / Acero Inoxidable

Medida: 9.8 x 13.2 cm

Área de Impresión: 5 x 5 cm

Técnica de Impresión: Serigrafía /

Tampografía

Capacidad: 16 Oz

Colores: Blanco

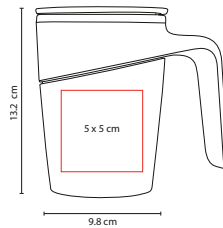

SISTEMA DE SUCCIÓN



Doble pared. Incluye tapa y chupón de succión que permite la fijación a la superficie evitando el derrame por accidente.



R



■ TAZ 016

TAZA AMIA

Material: Fibra de Arroz / Silicón

Medida: 8.5 x 15.5 cm

Área de Impresión: 5.5 x 8 cm

Técnica de Impresión: Serigrafía /

Tampografía

Capacidad: 16 Oz

Colores: A/N/R/V

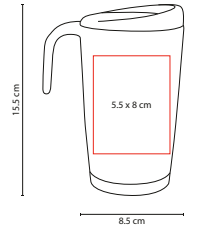

A



N



V

Cuenta con tapa y base de silicón. Venta individual.



R



■ TAZ 001

TAZA ESPIRIT

Material: Cerámica

Medida: 8 x 9.5 cm

Área de Impresión: 5.5 x 5.5 cm

Técnica de Impresión: Grabado en Arena /

Serigrafía / Termocalca

Capacidad: 11 Oz

Colores: A/AR/B/N/O/R/V

■ ■ Colores GTM: A/AR/O/R/V

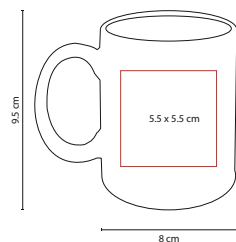

AR

O

A

N

B

V

Venta caja cerrada de 36 piezas.



N



■ TAZ 031

TAZA FIORLAND

Material: Cerámica / Bambú

Medida: 10 x 11 cm

Área de Impresión: 6 x 6 cm

Técnica de Impresión: Grabado en Arena /

Serigrafía / Tampografía

Capacidad: 16 Oz

Colores: B/N

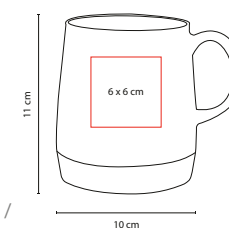

B

Cuenta con base de bambú. No usar en microondas ni lavavajillas. Venta individual.





TAZA RIMO
TAZ 026





Y



■ TMPS 201

TAZA TÉRMICA WAKE CUP

Material: Plástico / Acero Inoxidable

Medida: 9.7 x 14.5 cm

Área de Impresión: 5.5 x 4.4 cm

Técnica de Impresión: Serigrafía /
Tampografía

Capacidad: 12 Oz

Colores: A/Y

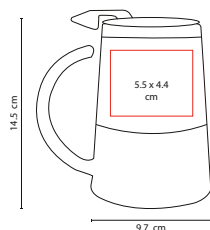

A

Doble pared. Asa de plástico. Incluye válvula de seguridad giratoria.



R



■ TMPS 26

TAZA TÉRMICA BURGOS

Material: Plástico / Acero Inoxidable

Medida: 9 x 12 cm

Área de Impresión: 5.9 x 6.2 cm

Técnica de Impresión: Serigrafía /
Tampografía

Capacidad: 12 Oz

Colores: A/N/R/T/V/Y

■ ■ ■ Colores GTM: A/N/R/T/Y

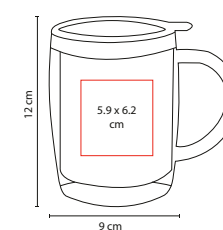

V



T



Y



A



N

Doble pared. Incluye válvula de seguridad giratoria con tapa de presión.





■ TAZ 024

TAZA KINSALE

Material: Acero Inoxidable / Plástico
 Medida: 10.5 x 13 cm
 Área de Impresión: 7 x 7 cm
 Técnica de Impresión: Pantógrafo / Serigrafía / Tampografía
 Capacidad: 14 Oz
 Colores: Plata

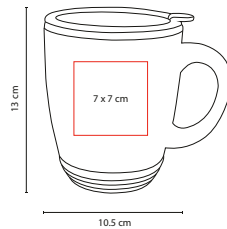

Doble pared.



A



■ TAZ 011

TAZA IRON

Material: Cerámica / Acero Inoxidable
 Medida: 8.7 x 11.9 cm
 Área de Impresión: 5 x 3.8 cm Cerámica / 4.6 x 3 cm Metal
 Técnica de Impresión: Láser / Pantógrafo / Tampografía
 Capacidad: 11 Oz
 Colores: A/B/N/R

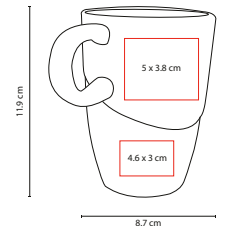

R



B



N

No usar en microondas ni lavavajillas. Venta caja cerrada de 36 piezas.



OFICINA

BOLÍGRAFOS



O



AC



A



R



V



N



B



Y

SH 1135

BOLÍGRAFO SLIM

Material: Plástico

Medida: 0.8 x 14.8 cm

Área de Impresión: 0.7 x 5.5 cm

Técnica de Impresión: Serigrafía

Tinta: Negra

Colores: A/AC/B/N/O/R/V/Y

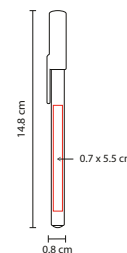

Bolígrafo con tapón.



A

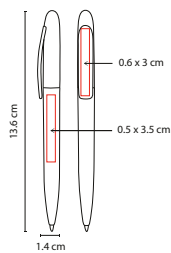

■ SH 1930

BOLÍGRAFO **BALBI**

Material: Plástico

Medida: 1.4 x 13.6 cm

Área de Impresión: 0.5 x 3.5 cm Barril / 0.6 x 3 cm Clip

Técnica de Impresión: Serigrafía

Tinta: Negra

Colores: A/O/R/V



R



V



O

Mecanismo twist.



V

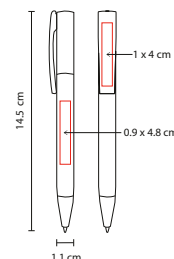

■ SH 1060

BOLÍGRAFO **TAMY**

Material: Plástico

Medida: 1.1 x 14.5 cm

Área de Impresión: 0.9 x 4.8 cm Barril / 1 x 4 cm Clip

Técnica de Impresión: Serigrafía

Tinta: Negra

Colores: A/N/O/R/V

■ ■ Colores GTM: A/N/O/R/V



A



N



O



R

Mecanismo twist.



R

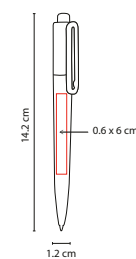

■ SH 1890

BOLÍGRAFO **TAI**

Material: Plástico

Medida: 1.2 x 14.2 cm

Área de Impresión: 0.6 x 6 cm

Técnica de Impresión: Serigrafía / Tampografía

Tinta: Negra

Colores: A/O/P/R/V

■ ■ Colores GTM: A/O/R/V



P



V



O



A

Mecanismo pulsador.



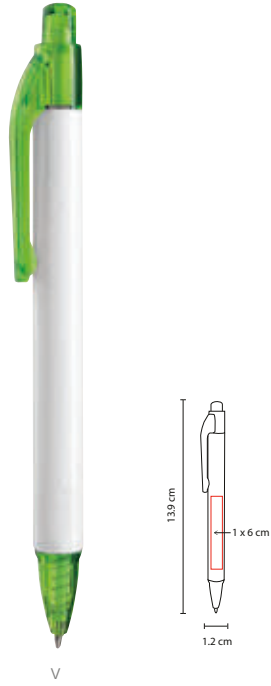

SH 1450

BOLÍGRAFO CHAD

Material: Plástico
 Medida: 1.2 x 13.9 cm
 Área de Impresión: 1 x 6 cm
 Técnica de Impresión: Serigrafía
 Tinta: Azul
 Colores: A/M/N/O/R/V/Y
 Colores GTM: A/M/N/O/R/V/Y



Mecanismo pulsador.



SH 1035

BOLÍGRAFO TXT

Material: Plástico
 Medida: 1 x 14 cm
 Área de Impresión: 0.8 x 4.5 cm
 Técnica de Impresión: Serigrafía
 Tinta: Negra
 Colores: A/N/O/R/V



Mecanismo pulsador.

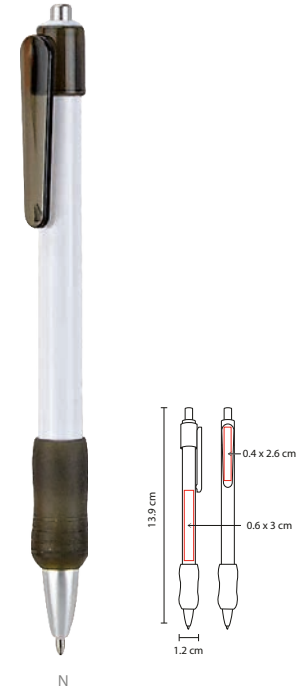

SH 1065

BOLÍGRAFO NAVIA

Material: Plástico
 Medida: 1.2 x 13.9 cm
 Área de Impresión: 0.6 x 3 cm Barril /
 0.4 x 2.6 cm Clip
 Técnica de Impresión: Serigrafía
 Tinta: Negra
 Colores: A/M/N/O/R/V
 Colores GTM: A/M/R/V



Grip antiderrapante. Mecanismo pulsador.



R

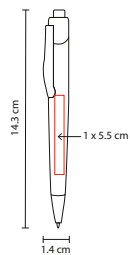

■ SH 2550

BOLÍGRAFO SONIX

Material: Plástico

Medida: 1.4 x 14.3 cm

Área de Impresión: 1 x 5.5 cm

Técnica de Impresión: Serigrafía

Tinta: Negra

Colores: A/O/R/V

Colores GTM: A/O/R/V



O

A

V

Mecanismo pulsador.



O

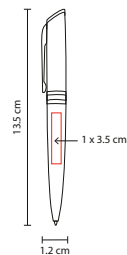

■ SH 1005

BOLÍGRAFO SCRIPT

Material: Plástico

Medida: 1.2 x 13.5 cm

Área de Impresión: 1 x 3.5 cm

Técnica de Impresión: Serigrafía

Tinta: Negra

Colores: A/N/O/R/V

Colores GTM: A/R/V



A

R

V

N

Mecanismo twist.



A

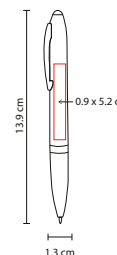

■ SH 2100

BOLÍGRAFO LACEY

Material: Plástico

Medida: 1.3 x 13.9 cm

Área de Impresión: 0.9 x 5.2 cm

Técnica de Impresión: Serigrafía

Tinta: Negra

Colores: A/N/O/R/V

Colores GTM: A/N/R/V



R

V

N

O

Mecanismo twist.





V

■ SH 1123

BOLÍGRAFO VIKINGO

Material: Plástico

Medida: 1.1 x 14.7 cm

Área de Impresión: 0.8 x 5 cm

Técnica de Impresión: Serigrafía

Tinta: Negra

Colores: A/AC/N/O/R/V/Y

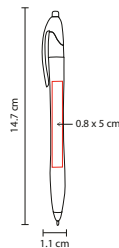

R

Y

A

AC

N

O

Mecanismo pulsador.



O

■ SH 1660

BOLÍGRAFO LIBER

Material: Plástico

Medida: 1.2 x 14 cm

Área de Impresión: 0.7 x 4.5 cm Barril /

0.5 x 3.5 cm Clip

Técnica de Impresión: Serigrafía

Tinta: Negra

Colores: AC/O/P/R/V/Y

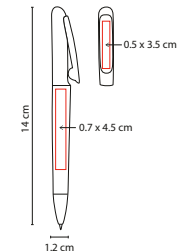

P

R

V

Y

AC

Mecanismo pulsador para ocultar el clip.



AC

■ SH 1315

BOLÍGRAFO OLEH

Material: Plástico

Medida: 1.2 x 14 cm

Área de Impresión: 1 x 3.5 cm Barril /
0.5 x 4 cm Clip

Técnica de Impresión: Serigrafía

Tinta: Negra

Colores: A/AC/M/N/O/R/V

■ ■ Colores GTM: AC/R/V

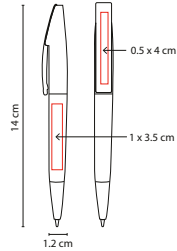

M

V

R

N

O

A

Mecanismo twist.



N

■ SH 2055

BOLÍGRAFO NIESEN

Material: Plástico

Medida: 1.2 x 14.3 cm

Área de Impresión: 0.7 x 3 cm
Técnica de Impresión: Serigrafía

Tinta: Azul

Colores: A/N/O/R/V

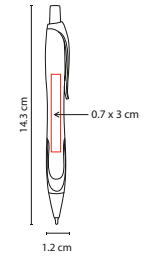

V

R

O

A

Mecanismo pulsador.





A

■ SH 2235

BOLÍGRAFO KILPANI

Material: Plástico
 Medida: 0.9 x 14.5 cm
 Área de Impresión: 0.5 x 5 cm
 Técnica de Impresión: Serigrafía
 Tinta: Azul
 Colores: A/N/O/R/V

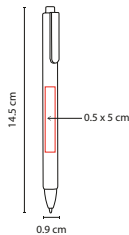

R

N

V

O

Mecanismo pulsador.



R

■ SH 9010

BOLÍGRAFO CLIP UP

Material: Plástico
 Medida: 1.4 x 13.5 cm
 Área de Impresión: 1 x 4.6 cm Barril /
 0.8 x 3.3 cm Clip
 Técnica de Impresión: Serigrafía
 Tinta: Negra
 Colores: A/AC/M/N/O/P/R/S/V/Y

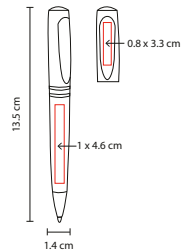

■ Colores GTM: A/AC/M/N/O/P/R/S/V/Y



S

P

V

N

O

Y

A

AC

M

Mecanismo twist para ocultar el clip.



Y

■ SH 1140

BOLÍGRAFO DEO

Material: Plástico

Medida: 1 x 14 cm

Área de Impresión: 0.8 x 2.5 cm

Técnica de Impresión: Serigrafía

Tinta: Negra

Colores: A/N/O/R/V/Y

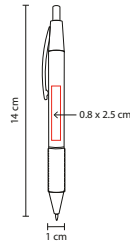

R

V

N

A

O

Grip antiderrapante. Mecanismo pulsador.



V

■ SH 1790

BOLÍGRAFO LISTER

Material: Plástico

Medida: 0.8 x 15.1 cm

Área de Impresión: 0.5 x 7 cm

Técnica de Impresión: Serigrafía

Tinta: Negra

Colores: A/B/M/N/O/P/R/V

Colores GTM: A/B/P/R/V

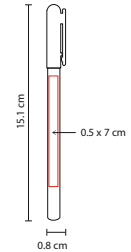

R

N

O

A

B

P

M

Bolígrafo con tapón.



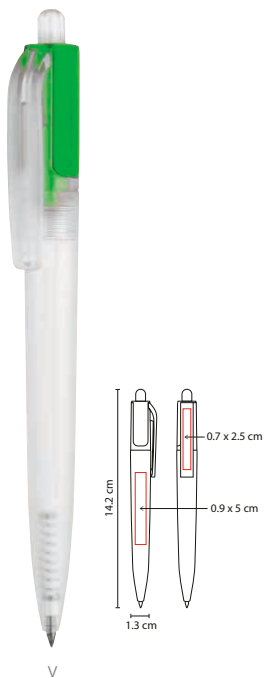

■ GEL 020

BOLÍGRAFO ALIS

Material: Plástico

Medida: 1.3 x 14.2 cm

Área de Impresión: 0.9 x 5 cm Barril /
0.7 x 2.5 cm Clip

Técnica de Impresión: Serigrafía /
Tampografía

Tinta: Gel Negra

Colores: A/N/R/V

Colores GTM: A/N/R/V



A R N

Mecanismo pulsador.



■ SH 2075

BOLÍGRAFO GLACIER

Material: Plástico

Medida: 1.1 x 14.2 cm

Área de Impresión: 0.6 x 3 cm

Técnica de Impresión: Serigrafía

Tinta: Negra

Colores: A/O/R/V/Y

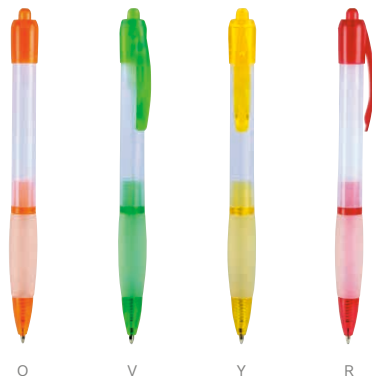

O V Y R

Grip antiderrapante. Mecanismo pulsador.

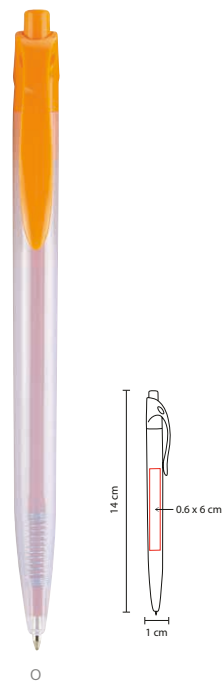

■ SH 1740

BOLÍGRAFO MAIA

Material: Plástico

Medida: 1 x 14 cm

Área de Impresión: 0.6 x 6 cm

Técnica de Impresión: Serigrafía

Tinta: Negra

Colores: A/O/P/V

Colores GTM: A/O/P/V



P A V

Mecanismo pulsador.

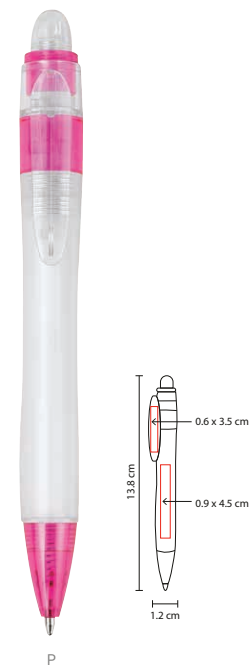

■ SH 1530

BOLÍGRAFO DESTINY

Material: Plástico

Medida: 1.2 x 13.8 cm

Área de Impresión: 0.9 x 4.5 cm Barril /
0.6 x 3.5 cm Clip

Técnica de Impresión: Serigrafía

Tinta: Negra

Colores: A/N/O/P/R/V

Colores GTM: A/N/O/P/R/V



O N V R A

Mecanismo pulsador.



R

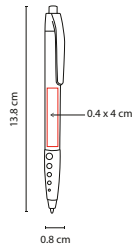

SH 2225

BOLÍGRAFO LUSAKA

Material: Plástico
 Medida: 0.8 x 13.8 cm
 Área de Impresión: 0.4 x 4 cm
 Técnica de Impresión: Serigrafía
 Tinta: Negra
 Colores: A/N/O/R/P/V



A

O

V

P

N

Grip antiderrapante. Mecanismo pulsador.



M

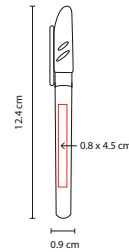

SH 1460

BOLÍGRAFO VENTURE

Material: Plástico
 Medida: 0.9 x 12.4 cm
 Área de Impresión: 0.8 x 4.5 cm
 Técnica de Impresión: Serigrafía
 Tinta: Negra
 Colores: A/M/N/O/R/V
 Colores GTM: A/M/N/O/R/V



A

O

R

N

V

Bolígrafo con tapón.



V

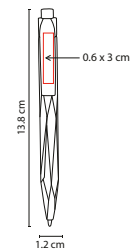

SH 2045

BOLÍGRAFO ALSAFI

Material: Plástico
 Medida: 1.2 x 13.8 cm
 Área de Impresión: 0.6 x 3 cm Clip
 Técnica de Impresión: Serigrafía
 Tinta: Negra
 Colores: A/B/R/V
 Colores GTM: A/B/R/V



B

R

A

Cuerpo con textura prismática. Mecanismo pulsador.



Premec
SWISS WITH PRIDE

Chalk+

SH 8500

BOLÍGRAFO CHALK

Material: Plástico

Medida: 1.2 x 13.9 cm

Área de Impresión: 0.9 x 6 cm

Técnica de Impresión: Serigrafía

Tinta: Negra

Colores: A/AC/B/N/O/P/R/V/Y

Colores GTM: A/AC/B/N/O/P/R/V/Y

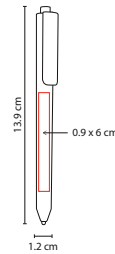

R



N



V



P



O



Y



A



B



AC

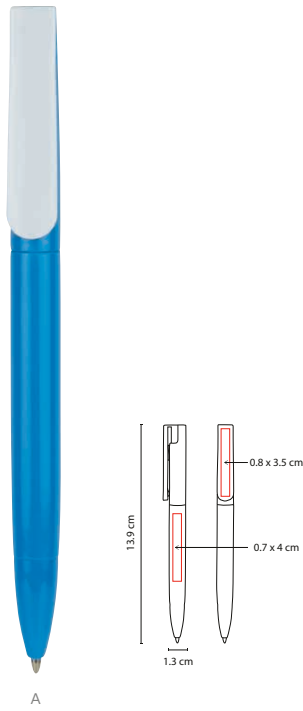

SH 1560

BOLÍGRAFO ISEO

Material: Plástico

Medida: 1.3 x 13.9 cm

Área de Impresión: 0.7 x 4 cm Barril / 0.8 x 3.5 cm Clip

Técnica de Impresión: Serigrafía

Tinta: Negra

Colores: A/O/R/V



Mecanismo pulsador.

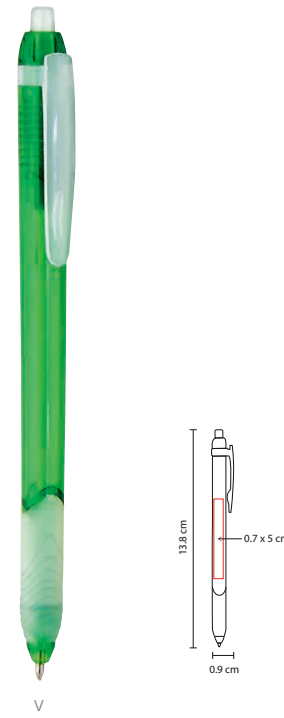

SH 1630

BOLÍGRAFO MAGDE

Material: Plástico

Medida: 0.9 x 13.8 cm

Área de Impresión: 0.7 x 5 cm

Técnica de Impresión: Serigrafía

Tinta: Negra

Colores: A/N/R/V/Y

Colores GTM: A/R/V



Grip antiderrapante. Mecanismo pulsador.

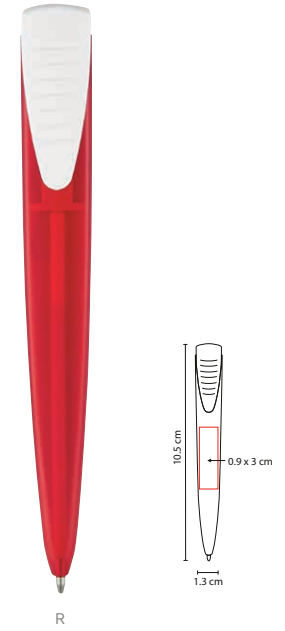

SH 2820

BOLÍGRAFO EZZOR

Material: Plástico

Medida: 1.3 x 10.5 cm

Área de Impresión: 0.9 x 3 cm

Técnica de Impresión: Serigrafía

Tinta: Negra

Colores: A/B/N/R



Cuerpo plano. Mecanismo pulsador.



OT

■ SH 2097

BOLÍGRAFO **FUROR**

Material: Plástico
Medida: 1.1 x 13.8 cm

Área de Impresión: 0.8 x 4.2 cm
Técnica de Impresión: Serigrafía
Tinta: Negra

Colores: AC/AT/OT/PT/RT/VT/WT/YT
■ Colores GTM: AT/RT/VT/WT/YT

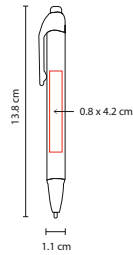

YT

PT

AC

VT

WT

RT

AT

Mecanismo pulsador.



PT

■ SH 1520

BOLÍGRAFO **WALEN**

Material: Plástico
Medida: 1.2 x 13.6 cm

Área de Impresión: 0.6 x 4 cm
Técnica de Impresión: Serigrafía
Tinta: Negra

Colores: AT/BT/NT/OT/PT/RT/VT

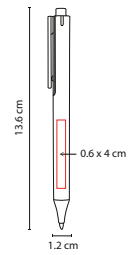

AT

BT

NT

VT

RT

OT

Mecanismo pulsador.





V

■ SH 2215

BOLÍGRAFO **ATKA**

Material: Plástico
 Medida: 1 x 13.5 cm
 Área de Impresión: 0.5 x 3 cm
 Técnica de Impresión: Serigrafía
 Tinta: Negra
 Colores: A/O/R/V

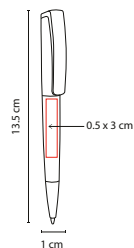

O



R



A

Mecanismo twist.



A

■ SH 2025

BOLÍGRAFO **ROSEG**

Material: Plástico
 Medida: 1.2 x 14 cm
 Área de Impresión: 0.6 x 4 cm Barril /
 0.7 x 3 cm Clip
 Técnica de Impresión: Serigrafía
 Tinta: Azul
 Colores: A/B/N/O/P/R/V/Y
 Colores GTM: A/B/O/R/V

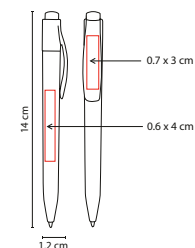

R



V



B



O



Y



N



P

Mecanismo pulsador.

e-venti

 erga

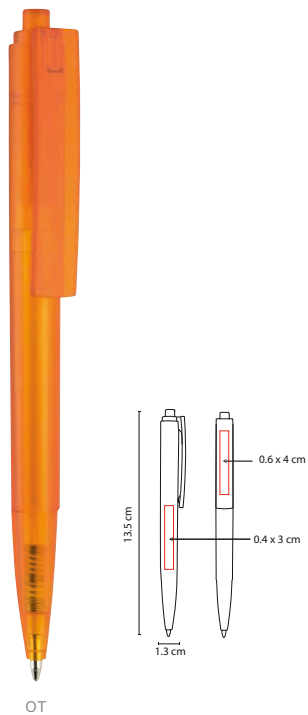

OT

■ SH 2920

BOLÍGRAFO E-VENTI

Material: Plástico
 Medida: 1.3 x 13.5 cm

Área de Impresión: 0.4 x 3 cm Barril / 0.6 x 4 cm Clip

Técnica de Impresión: Serigrafía

Tinta: Negra

Colores: AT/BT/OT/RT/VT



AT

BT

RT

VT

Hecho en Italia. Mecanismo pulsador.

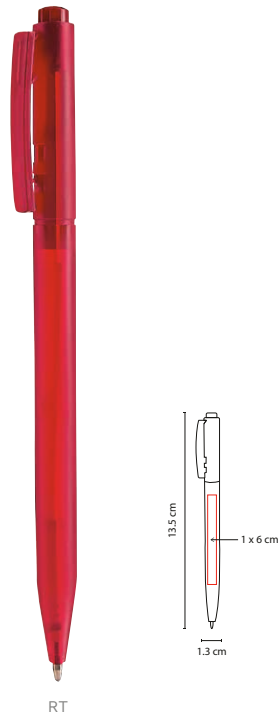

RT

■ SH 1405

BOLÍGRAFO KIVU

Material: Plástico
 Medida: 1.3 x 13.5 cm

Área de Impresión: 1 x 6 cm

Técnica de Impresión: Serigrafía

Tinta: Negra

Colores: Blanco Sólido / AT/RT/VT/YT Translúcidos

 Colores GTM: Blanco Sólido / AT/RT Translúcidos



VT

YT

AT

B

Mecanismo pulsador.

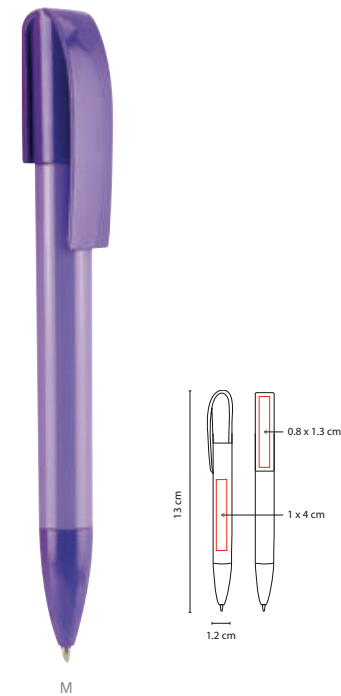

M

■ SH 1750

BOLÍGRAFO BITONO ARIK

Material: Plástico
 Medida: 1.2 x 13 cm

Área de Impresión: 1 x 4 cm Barril / 0.8 x 1.3 cm Clip

Técnica de Impresión: Serigrafía

Tinta: Negra

Colores: A/M/O/P/R/V



R

V

A

P

O

Mecanismo twist.





O

■ SH 2015

BOLÍGRAFO HOLI-HOLY

Material: Plástico
 Medida: 1.1 x 14.3 cm
 Área de Impresión: 0.6 x 5 cm Barril /
 0.5 x 3.5 cm Clip
 Técnica de Impresión: Serigrafía
 Tinta: Azul
 Colores: A/B/N/O/P/R/V/Y

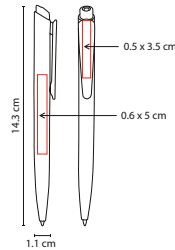

R B N V A Y P

Mecanismo pulsador.



V

■ SH 1755

BOLÍGRAFO BITONO SKADY

Material: Plástico
 Medida: 1.2 x 13.9 cm
 Área de Impresión: 1 x 6 cm
 Técnica de Impresión: Serigrafía
 Tinta: Negra
 Colores: A/M/O/P/R/V
 Colores GTM: A/R/V

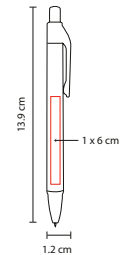

P A M O R

Mecanismo pulsador.



M

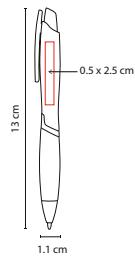

■ SH 2410

BOLÍGRAFO KORAB

Material: Plástico

Medida: 1.1 x 13 cm

Área de Impresión: 0.5 x 2.5 cm

Técnica de Impresión: Serigrafía

Tinta: Negra

Colores: A/M/O/P/R/V

☞ Colores GTM: A/O/R/V



Mecanismo pulsador.



A

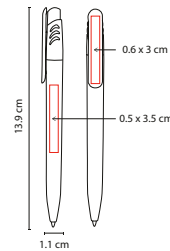

■ SH 2420

BOLÍGRAFO TEIDE

Material: Plástico

Medida: 1.1 x 13.9 cm

Área de Impresión: 0.5 x 3.5 cm Barril / 0.6 x 3 cm Clip

Técnica de Impresión: Serigrafía

Tinta: Negra

Colores: A/B/O/R/V

☞ Colores GTM: A/B/O/R/V



Mecanismo pulsador.



V

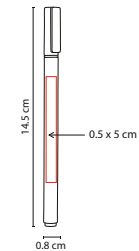

■ SH 2065

BOLÍGRAFO SKINNY

Material: Plástico

Medida: 0.8 x 14.5 cm

Área de Impresión: 0.5 x 5 cm

Técnica de Impresión: Serigrafía

Tinta: Negra

Colores: A/O/R/V

☞ Colores GTM: A/R

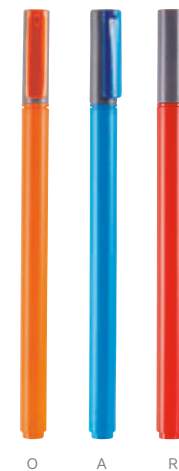

Bolígrafo con tapón.





AT

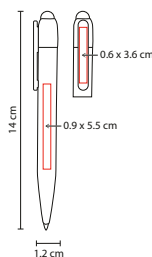

■ SH 3100

BOLÍGRAFO INFINITY

Material: Plástico

Medida: 1.2 x 14 cm

Área de Impresión: 0.9 x 5.5 cm Barril / 0.6 x 3.6 cm Clip

Técnica de Impresión: Serigrafía

Tinta: Negra

Colores: AT/BT/OT/RT/VT

Colores GTM: AT/BT/OT/RT/VT



VT



RT



BT



OT

Mecanismo pulsador.



R

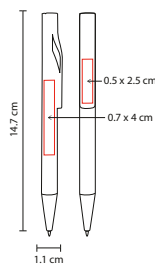

■ SH 1770

BOLÍGRAFO KADIAN

Material: Plástico

Medida: 1.1 x 14.7 cm

Área de Impresión: 0.7 x 4 cm Barril / 0.5 x 2.5 cm Clip

Técnica de Impresión: Serigrafía

Tinta: Negra

Colores: A/B/R/V

Colores GTM: A/B/R/V



V



B



A

Mecanismo pulsador.



G

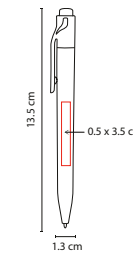

■ SH 2415

BOLÍGRAFO ILLER

Material: Plástico

Medida: 1.3 x 13.5 cm

Área de Impresión: 0.5 x 3.5 cm

Técnica de Impresión: Serigrafía

Tinta: Negra

Colores: A/G/R/S/V



A



V



R



S

Mecanismo pulsador.



V

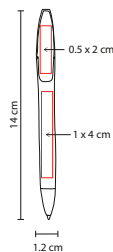

■ GEL 050

BOLÍGRAFO **HIDROGEL**

Material: Plástico

Medida: 1.2 x 14 cm

Área de Impresión: 1 x 4 cm Barril / 0.5 x 2 cm Clip

Técnica de Impresión: Serigrafía

Tinta: Gel Negra

Colores: A/N/R/V

■ ■ Colores GTM: A/N/R/V



N

R

A

Mecanismo twist.



A

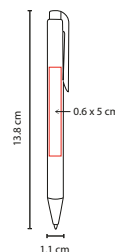

■ SH 2320

BOLÍGRAFO **ELBING**

Material: Plástico

Medida: 1.1 x 13.8 cm

Área de Impresión: 0.6 x 5 cm

Técnica de Impresión: Serigrafía

Tinta: Azul

Colores: A/N/O/P/R/V

■ ■ Colores GTM: A/O/R/V



V

O

R

P

N

Mecanismo pulsador.



P

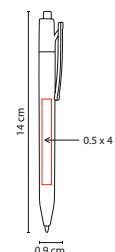

■ SH 2085

BOLÍGRAFO **ESSEX**

Material: Plástico

Medida: 0.9 x 14 cm

Área de Impresión: 0.5 x 4 cm

Técnica de Impresión: Serigrafía

Tinta: Negra

Colores: A/O/P/V/Y

■ ■ Colores GTM: A/O/P/V



O

Y

A

V

Bolígrafo neón. Mecanismo pulsador.





O

SH 2430

BOLÍGRAFO **ATREK**

Material: Plástico
 Medida: 1.1 x 14.4 cm
 Área de Impresión: 0.5 x 3.5 cm
 Técnica de Impresión: Serigrafía
 Tinta: Negra
 Colores: A/O/R/V

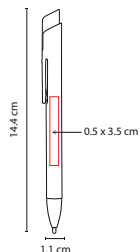

V

R

A

Mecanismo pulsador.



V

SH 1325

BOLÍGRAFO **VHORI**

Material: Plástico
 Medida: 1.2 x 14 cm
 Área de Impresión: 1 x 3.5 cm Barril / 0.5 x 4 cm Clip
 Técnica de Impresión: Serigrafía
 Tinta: Negra
 Colores: A/AC/N/O/R/V

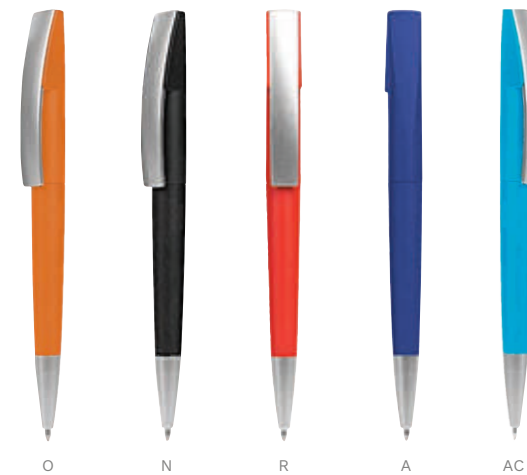
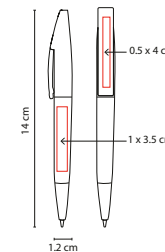

O

N

R

A

AC

Mecanismo twist.



R

■ SH 1045

BOLÍGRAFO VOITTA

Material: Plástico
Medida: 1 x 14.1 cm
Área de Impresión: 0.8 x 4 cm
Técnica de Impresión: Serigrafía
Tinta: Negra
Colores: A/O/R/V/Y

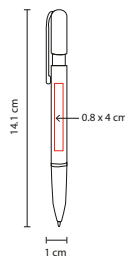

Y

A

V

O

Grip antiderrapante. Mecanismo pulsador.



A

■ SH 1340

BOLÍGRAFO ROA

Material: Plástico
Medida: 1 x 14.5 cm
Área de Impresión: 0.8 x 9 cm
Técnica de Impresión: Serigrafía
Tinta: Negra

Colores: A/B/N/O/R/V/Y

Colores GTM: A/B/N/O/R/V/Y

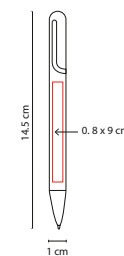

V

R

N

Y

O

B

Mecanismo twist.





N

■ SH 1085

BOLÍGRAFO SINAI

Material: Plástico

Medida: 1.1 x 14.5 cm

Área de Impresión: 0.8 x 4.6 cm Barril / 0.8 x 3 cm Clip

Técnica de Impresión: Serigrafía

Tinta: Negra

Colores: A/N/R/V

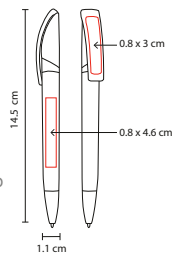

R

V

A

Mecanismo twist.



V

■ SH 1095

BOLÍGRAFO EKHOR

Material: Plástico

Medida: 1 x 14 cm

Área de Impresión: 0.8 x 4.7 cm

Técnica de Impresión: Serigrafía

Tinta: Negra

Colores: A/N/O/R/V

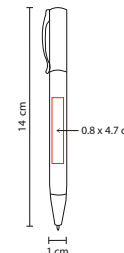

N

O

A

R

Mecanismo twist.



P

■ SH 1480

BOLÍGRAFO JAVARI

Material: Plástico
Medida: 1.2 x 13.6 cm
Área de Impresión: 0.6 x 4 cm
Técnica de Impresión: Serigrafía
Tinta: Negra
Colores: A/G/N/O/P/R/V

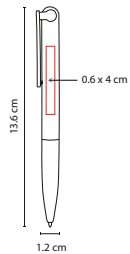

V

R

G

N

A

O

Grip antiderrapante. Mecanismo twist.



A

■ SH 1610

BOLÍGRAFO GALEO

Material: Plástico
Medida: 1.2 x 14.5 cm
Área de Impresión: 0.7 x 5 cm Barril / 0.5 x 3 cm Clip
Técnica de Impresión: Serigrafía
Tinta: Negra
Colores: A/G/R/V
☐ Colores GTM: A/G/R

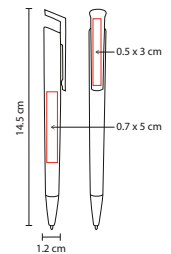

V

R

G

Mecanismo pulsador.



BOLÍGRAFO SKINNY SH 2065

Bolígrafo con tapón.



V

■ SH 1025

BOLÍGRAFO TRENDY

Material: Plástico

Medida: 1 x 14 cm

Área de Impresión: 0.8 x 4.5 cm

Técnica de Impresión: Serigrafía

Tinta: Negra

Colores: A/M/O/R/S/V Metalizados

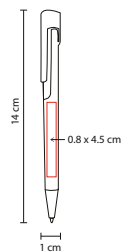

R



M



O



S



A

Mecanismo pulsador.



A

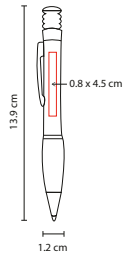

■ SH 1519

BOLÍGRAFO BOMBAY

Material: Plástico
Medida: 1.2 x 13.9 cm
Área de Impresión: 0.8 x 4.5 cm
Técnica de Impresión: Serigrafía
Tinta: Negra
Colores: A/B/N/R



N



R



B

Grip antiderrapante. Mecanismo pulsador.



R

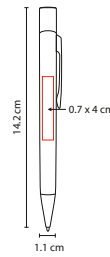

■ SH 1150

BOLÍGRAFO ILEK

Material: Plástico
Medida: 1.1 x 14.2 cm
Área de Impresión: 0.7 x 4 cm
Técnica de Impresión: Serigrafía
Tinta: Negra
Colores: A/R/S



S



A

Mecanismo twist.



G

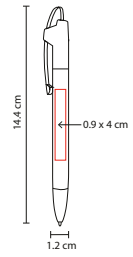

■ SH 1070

BOLÍGRAFO CELIO

Material: Plástico / Clip Metálico
Medida: 1.2 x 14.4 cm
Área de Impresión: 0.9 x 4 cm
Técnica de Impresión: Serigrafía
Tinta: Negra
Colores: A/G/N/R/S



N



A



R



S

Mecanismo pulsador.





SH 2260

BOLÍGRAFO EFFIE

Material: Plástico
 Medida: 1.1 x 14.3 cm
 Área de Impresión: 0.5 x 3 cm
 Técnica de Impresión: Serigrafía
 Tinta: Negra
 Colores: A/G/R

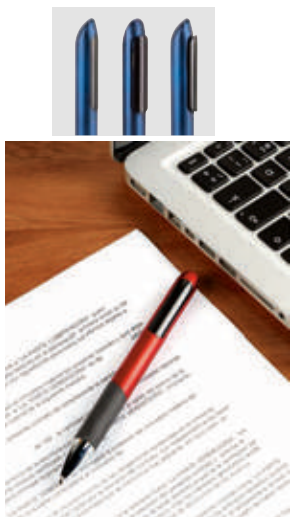

Grip antiderrapante. Mecanismo twist para ocultar el clip.

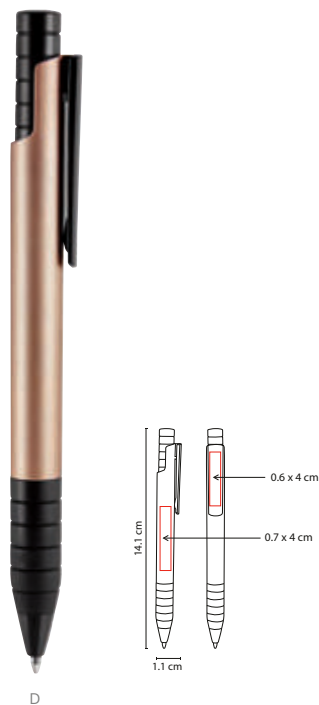

SH 2105

BOLÍGRAFO SOSVA

Material: Plástico
 Medida: 1.1 x 14.1 cm
 Área de Impresión: 0.7 x 4 cm Barril / 0.6 x 4 cm Clip
 Técnica de Impresión: Serigrafía
 Tinta: Negra
 Colores: A/D/G/R



Grip antiderrapante. Mecanismo pulsador.

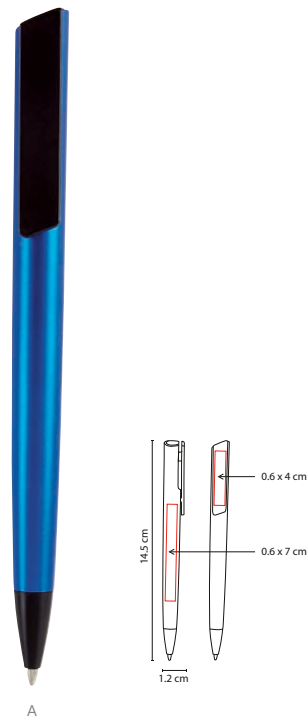

SH 2035

BOLÍGRAFO OTARA

Material: Plástico
 Medida: 1.2 x 14.5 cm
 Área de Impresión: 0.6 x 7 cm Barril / 0.6 x 4 cm Clip
 Técnica de Impresión: Serigrafía
 Tinta: Negra
 Colores: A/G/R



Mecanismo pulsador.



N

■ SH 2240

BOLÍGRAFO DAKAR

Material: Plástico
 Medida: 1 x 14.5 cm
 Área de Impresión: 0.5 x 4 cm
 Técnica de Impresión: Serigrafía
 Tinta: Azul
 Colores: A/N/R

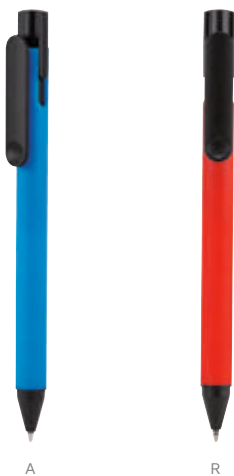

A

R

Mecanismo pulsador.



A

■ SH 2230

BOLÍGRAFO GORELY

Material: plástico
 Medida: 0.8 x 13.7 cm
 Área de Impresión: 0.4 x 3 cm
 Técnica de Impresión: Serigrafía
 Tinta: Azul
 Colores: A/B/N/R



R

B

N

Mecanismo twist.

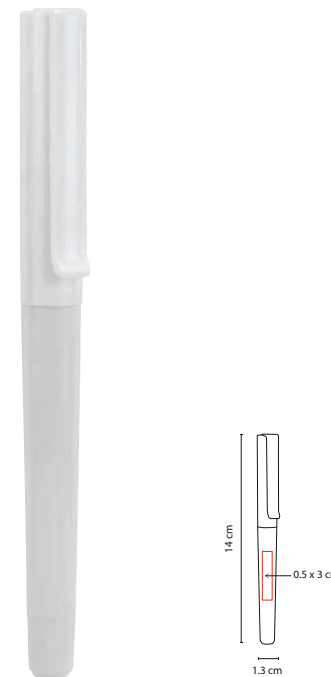

■ SH 2330

BOLÍGRAFO PUMIRI

Material: Plástico
 Medida: 1.3 x 14 cm
 Área de Impresión: 0.5 x 3 cm
 Técnica de Impresión: Serigrafía
 Tinta: Negra
 Colores: Blanco



Bolígrafo fuente con tapón. Incluye cartucho de tinta.





B

■ GEL 001

BOLÍGRAFO AQUAGEL

Material: Plástico
 Medida: 1.2 x 13.5 cm
 Área de Impresión: 1 x 3.5 cm Barril / 0.5 x 2 cm Clip
 Técnica de Impresión: Serigrafía
 Tinta: Gel Negra
 Colores: A/B/N/R
 Colores GTM: A/N/R

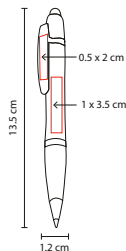

R



A



N

Grip antiderrapante. Mecanismo pulsador.

ZEGNO®
 ESCRITURA

■ GEL 030

BOLÍGRAFO KHOR

Material: Plástico
 Medida: 1.4 x 12.8 cm
 Área de Impresión: 0.6 x 3 cm
 Técnica de Impresión: Serigrafía
 Tinta: Gel Negra
 Colores: A/N/R/V

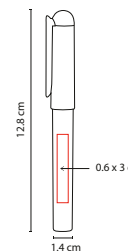

N



V



R



A

Bolígrafo con tapón.

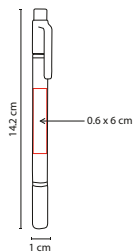

■ ECO 015

BOLÍGRAFO **KATMAI**

Material: Cartón / Plástico

Medida: 1 x 14.2 cm

Área de Impresión: 0.6 x 6 cm

Técnica de Impresión: Serigrafía

Tinta: Negra

Colores: Amarillo



Bolígrafo y marcatexto con tapón. Material Eco-Friendly.

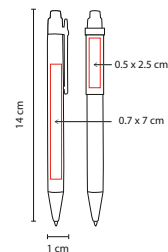

■ ECO 010

BOLÍGRAFO **PLANET**

Material: Cartón / Plástico

Medida: 1 x 14 cm

Área de Impresión: 0.7 x 7 cm Barril / 0.5 x 2.5 cm Clip

Técnica de Impresión: Serigrafía

Tinta: Negra

Colores: A/O/R/V

Colores GTM: A/R/V



R A V

Material Eco-Friendly. Mecanismo pulsador.

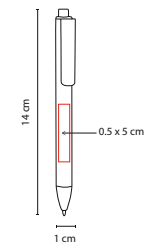

■ ECO 025

BOLÍGRAFO **MATOBO**

Material: Cartón / Plástico

Medida: 1 x 14 cm

Área de Impresión: 0.5 x 5 cm

Técnica de Impresión: Serigrafía

Tinta: Negra

Colores: A/O/R/V



A O R

Material Eco-Friendly. Mecanismo pulsador.



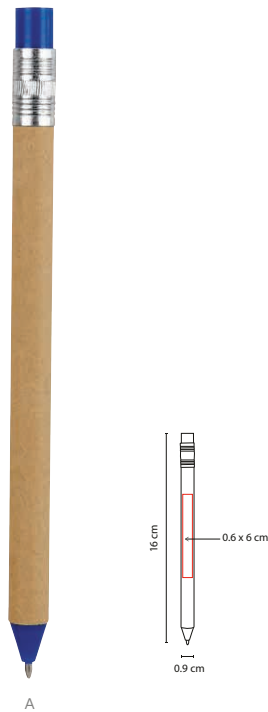

ECO 035

BOLÍGRAFO ZAMBEZE

Material: Cartón / Plástico
 Medida: 0.9 x 16 cm
 Área de Impresión: 0.6 x 6 cm
 Técnica de Impresión: Serigrafía
 Tinta: Negra
 Colores: A/O/R/V
 Colores GTM: A/O/R/V



Material Eco-Friendly. Mecanismo pulsador.

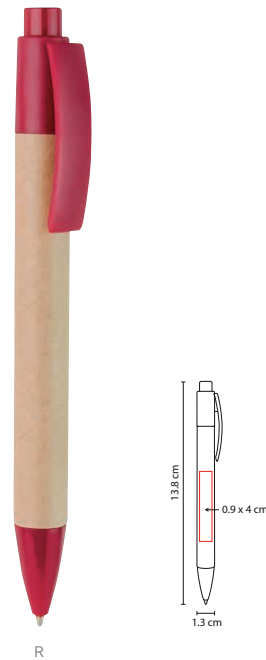

ECO 030

BOLÍGRAFO LANZ

Material: Cartón / Plástico
 Medida: 1.3 x 13.8 cm
 Área de Impresión: 0.9 x 4 cm
 Técnica de Impresión: Serigrafía
 Tinta: Negra
 Colores: A/O/R/V



Material Eco-Friendly. Mecanismo pulsador.

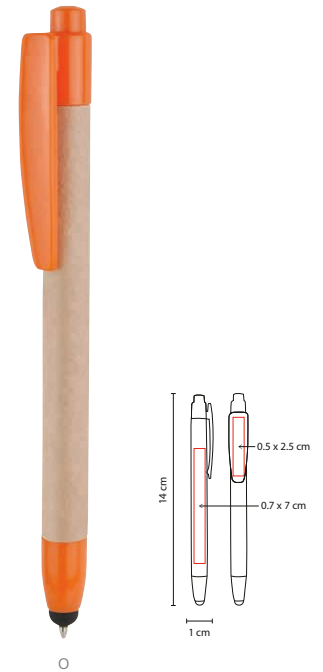

ECO 020

BOLÍGRAFO BIO

Material: Cartón / Plástico
 Medida: 1 x 14 cm
 Área de Impresión: 0.7 x 7 cm Barril / 0.5 x 2.5 cm Clip
 Técnica de Impresión: Serigrafía
 Tinta: Negra
 Colores: A/B/O/R/V
 Colores GTM: A/B/O/R/V



BOLÍGRAFO



TOUCH SCREEN



Bolígrafo con touch screen. Material Eco-Friendly. Mecanismo pulsador.



BOLÍGRAFO



TOUCH SCREEN



A

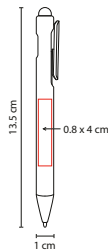

■ SH 2850

BOLÍGRAFO **LIVENZA**

Material: Plástico

Medida: 1 x 13.5 cm

Área de Impresión: 0.8 x 4 cm

Técnica de Impresión: Serigrafía

Tinta: Negra

Colores: A/R/V

Colores GTM: A/R/V



V

R

Bolígrafo con touch screen.
Mecanismo pulsador para ocultar el clip.



O

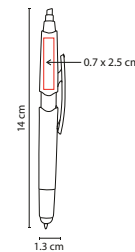

■ SH 2125

BOLÍGRAFO **BONDI**

Material: Plástico

Medida: 1.3 x 14 cm

Área de Impresión: 0.7 x 2.5 cm

Técnica de Impresión: Serigrafía

Tinta: Azul

Colores: A/B/O/V



B

A

V

Bolígrafo con touch screen y marcatejto. Mecanismo pulsador.



V

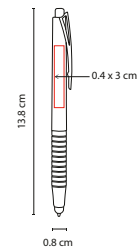

■ SH 2250

BOLÍGRAFO **HISWA**

Material: Plástico

Medida: 0.8 x 13.8 cm

Área de Impresión: 0.4 x 3 cm

Técnica de Impresión: Serigrafía

Tinta: Negra

Colores: A/B/O/R/V

Colores GTM: A/R

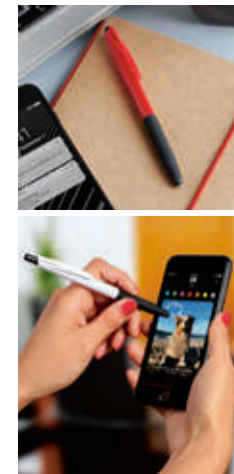

A

R

B

O

Bolígrafo con touch screen y grip antiderrapante.
Mecanismo pulsador.





TOUCH SCREEN



BOLÍGRAFO



O

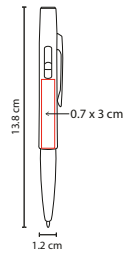

SH 1285

BOLÍGRAFO KARTUZY

Material: Plástico
 Medida: 1.2 x 13.8 cm
 Área de Impresión: 0.7 x 3 cm
 Técnica de Impresión: Serigrafía
 Tinta: Negra
 Colores: A/B/O/R/V



Bolígrafo con touch screen y tapón. Terminado rubber.



TOUCH SCREEN



BOLÍGRAFO



A

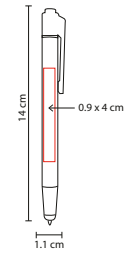

SH 1845

BOLÍGRAFO CENIT

Material: Aluminio
 Medida: 1.1 x 14 cm
 Área de Impresión: 0.9 x 4 cm
 Técnica de Impresión: Láser / Serigrafía
 Tinta: Negra
 Colores: A/G
 Colores GTM: A/G



G

Bolígrafo con touch screen. Mecanismo pulsador. Incluye funda.



R

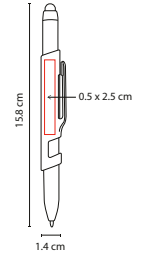

SH 2860

BOLÍGRAFO DENE B

Material: Plástico
 Medida: 1.4 x 15.8 cm
 Área de Impresión: 0.5 x 2.5 cm
 Técnica de Impresión: Serigrafía
 Tinta: Negra
 Colores: A/B/R/S/V



B

S

V

A

Bolígrafo con touch screen y base para smartphone. Terminado rubber.



TOUCH SCREEN



BOLÍGRAFO



V

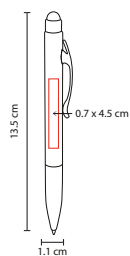

SH 1860

BOLÍGRAFO LUNDY

Material: Aluminio

Medida: 1.1 x 13.5 cm

Área de Impresión: 0.7 x 4.5 cm

Técnica de Impresión: Láser / Serigrafía

Tinta: Negra

Colores: A/M/O/R/V



A

M

O

R

Bolígrafo con touch screen y grip antiderrapante.
Mecanismo twist. Incluye funda.



G

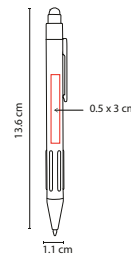

ZEGNO® SH 2310

BOLÍGRAFO LINX

Material: Aluminio

Medida: 1.1 x 13.6 cm

Área de Impresión: 0.5 x 3 cm

Técnica de Impresión: Láser / Serigrafía

Tinta: Negra

Colores: A/G/R



A

R

Bolígrafo con touch screen y grip antiderrapante.
Mecanismo pulsador. Incluye funda.



TOUCH SCREEN



BOLÍGRAFO



G

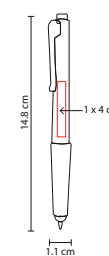

SH 1015

BOLÍGRAFO GLIT

Material: Plástico

Medida: 1.1 x 14.8 cm

Área de Impresión: 1 x 4 cm

Técnica de Impresión: Serigrafía

Tinta: Negra

Colores: A/G/R/S

Colores GTM: A/G/R/S

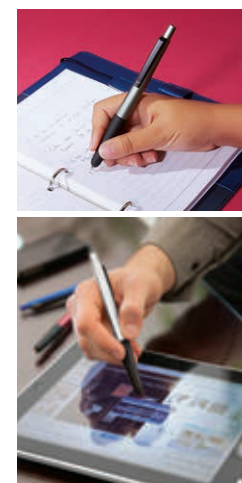

R

A

S

Bolígrafo con touch screen y grip antiderrapante.
Mecanismo pulsador.





D

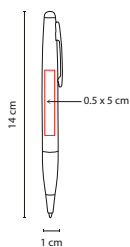

ZEGNO® ■ SH 2380
ESCRITURA

BOLÍGRAFO TAHUA

Material: Aluminio
Medida: 1 x 14 cm

Área de Impresión: 0.5 x 5 cm

Técnica de Impresión: Grabado Espejo / Serigrafía

Tinta: Negra

Colores: D/G/N



G



N

Bolígrafo con touch screen y grip antiderrapante. Incluye funda.



■ SH 1830

BOLÍGRAFO KAEDI

Material: Plástico
Medida: 1.2 x 12.2 cm

Área de Impresión: 0.6 x 5 cm

Técnica de Impresión: Serigrafía

Tinta: Negra

Colores: Plata

Colores GTM: Plata

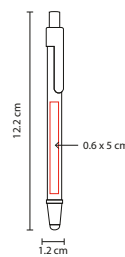

TOUCH SCREEN



BOLÍGRAFO

Bolígrafo con touch screen. Mecanismo pulsador.



R

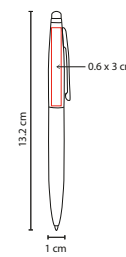

■ SH 2580

BOLÍGRAFO TATIN

Material: Aluminio
Medida: 1 x 13.2 cm

Área de Impresión: 0.6 x 3 cm

Técnica de Impresión: Láser / Serigrafía

Tinta: Negra

Colores: A/B/R



B



A

Bolígrafo con touch screen. Mecanismo twist. Incluye estuche.

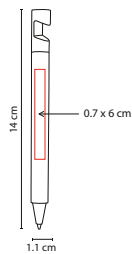

■ SH 2135

BOLÍGRAFO **USSURI**

Material: Plástico
Medida: 1.1 x 14 cm

Área de Impresión: 0.7 x 6 cm
Técnica de Impresión: Serigrafía
Tinta: Azul
Colores: Gris



Bolígrafo con base para smartphone. Mecanismo twist.

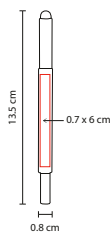

■ SH 1980

BOLÍGRAFO **KIROVA**

Material: Aluminio
Medida: 0.8 x 13.5 cm

Área de Impresión: 0.7 x 6 cm
Técnica de Impresión: Láser
Tinta: Negra
Colores: Plata



TOUCH SCREEN APUNTADOR LÁSER BOLÍGRAFO

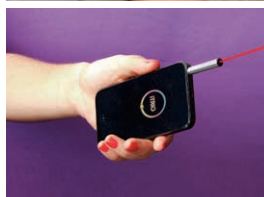

Bolígrafo con punta touch y apuntador láser. La aplicación iTrio es necesaria para convertir tu smartphone o tablet en puntero láser, es gratuita. Pregunta a tu Ejecutivo por modelos compatibles. Incluye estuche.

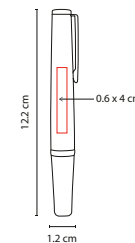

■ SH 1865

BOLÍGRAFO **KARIBA**

Material: Plástico
Medida: 1.2 x 12.2 cm

Área de Impresión: 0.6 x 4 cm
Técnica de Impresión: Serigrafía
Tinta: Negra
Colores: Gris



Bolígrafo con touch screen. Doble mecanismo twist.



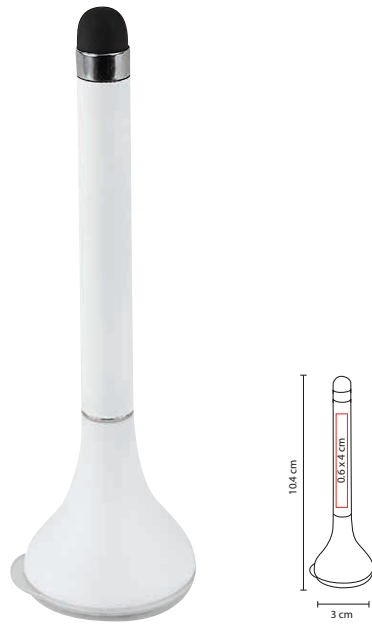

SH 1825

BOLÍGRAFO **EVENY**

Material: Plástico
 Medida: 3 x 10.4 cm
 Área de Impresión: 0.6 x 4 cm
 Técnica de Impresión: Serigrafía
 Tinta: Negra
 Colores: Blanco



Bolígrafo con touch screen y base con limpiador de pantalla en tapón.



SH 2115

BOLÍGRAFO CON BASE **MINOS**

Material: Plástico
 Medida: 5 x 16 cm
 Área de Impresión: 2 x 1.5 cm Base /
 0.5 x 5 cm Bolígrafo
 Técnica de Impresión: Serigrafía
 Tinta: Negra
 Colores: A/G/R



Incluye adhesivo en la parte inferior.



BORRADOR



BOLÍGRAFO



SH 1365

BOLÍGRAFO **ALSTER**

Material: Plástico
 Medida: 1.3 x 14 cm
 Área de Impresión: 0.6 x 3 cm
 Técnica de Impresión: Serigrafía
 Tinta: Gel Negra
 Colores: A/N/R



Bolígrafo con tinta de gel térmico-sensitiva que se borra con la fricción del borrador. Grip antideslizante. Mecanismo pulsador en el clip.

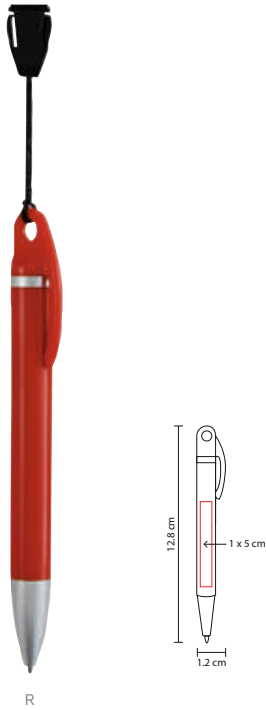

R

■ SH 1600

BOLÍGRAFO COEL

Material: Plástico
 Medida: 1.2 x 12.8 cm
 Área de Impresión: 1 x 5 cm
 Técnica de Impresión: Serigrafía
 Tinta: Negra
 Colores: A/B/R
 Colores GTM: A/B/R



B

A

Incluye cordón. Mecanismo twist.



N

■ SH 1215

BOLÍGRAFO 3 EN 1 SMOKE

Material: Plástico
 Medida: 1.3 x 14 cm
 Área de Impresión: 1 x 3 cm
 Técnica de Impresión: Serigrafía
 Tinta: Azul / Negra / Roja
 Colores: A/N/R
 Colores GTM: A/N/R



A

R

Mecanismo pulsador por tinta.

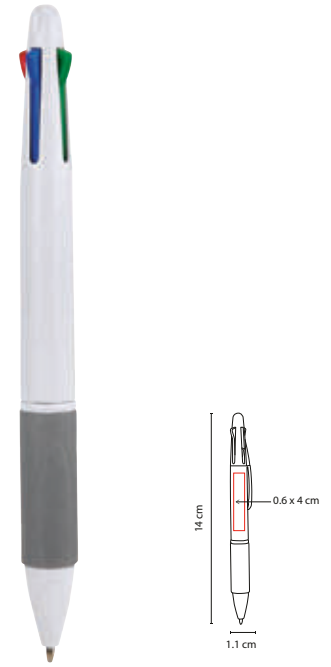

■ SH 1765

BOLÍGRAFO LOJA

Material: Plástico
 Medida: 1.1 x 14 cm
 Área de Impresión: 0.6 x 4 cm
 Técnica de Impresión: Serigrafía
 Tinta: Azul / Negra / Roja / Verde
 Colores: Gris
 Colores GTM: Gris



Grip antiderrapante. Mecanismo pulsador por tinta.





SH 1850

BOLÍGRAFO CON LUZ JASER

Material: Plástico
 Medida: 1.5 x 13 cm
 Área de Impresión: 0.6 x 4 cm
 Técnica de Impresión: Serigrafía /
 Tampografía
 Tinta: Negra
 Colores: Blanco
 Colores GTM: Blanco



Bolígrafo con lámpara de 1 LED.
 Mecanismo twist. Incluye batería.



SH 1710

BOLÍGRAFO ROCKET

Material: Plástico
 Medida: 2.1 x 12.4 cm
 Área de Impresión: 1 x 4.5 cm
 Técnica de Impresión: Serigrafía
 Tinta: Negra
 Colores: Plata



Mecanismo pulsador.



SH 2005

BOLÍGRAFO PROFESSION

Material: Plástico
 Medida: 3.1 x 16 cm
 Área de Impresión: 0.7 x 8 cm Bolígrafo /
 1.3 x 0.7 cm Figura
 Técnica de Impresión: Serigrafía
 Tinta: Negra
 Colores: Blanco

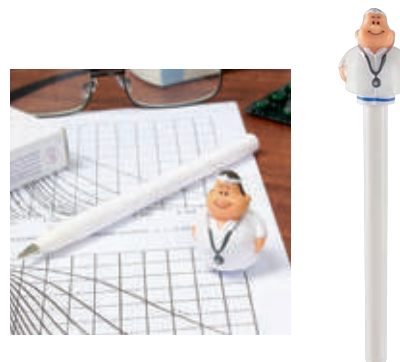

Bolígrafo con figura en el tapón.



SH 1100

BOLÍGRAFO MASARYK

Material: Plástico
 Medida: 1.1 x 14 cm
 Área de Impresión: 0.9 x 4 cm
 Técnica de Impresión: Serigrafía
 Tinta: Negra
 Colores: A/N/R



Bolígrafo con lámpara y grip antiderrapante.
 Mecanismo twist. Incluye batería.

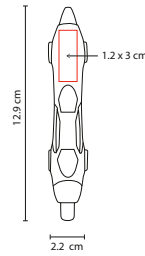

■ SH 8000

BOLÍGRAFO CAR

Material: Plástico
 Medida: 2.2 x 12.9 cm
 Área de Impresión: 1.2 x 3 cm
 Técnica de Impresión: Serigrafía
 Tinta: Negra
 Colores: Plata



Mecanismo pulsador.

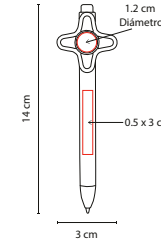

■ SH 2460

BOLÍGRAFO BOUVET

Material: Plástico
 Medida: 3 x 14 cm
 Área de Impresión: 0.5 x 3 cm Barril / 1.2 cm Diámetro
 Técnica de Impresión: Goteado en Resina / Serigrafía
 Tinta: Negra
 Colores: A/B/R

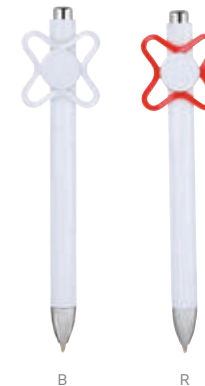

Bolígrafo spinner. Mecanismo pulsador.

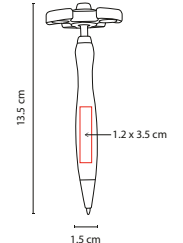

■ SH 2440

BOLÍGRAFO SPINNER HOPPY

Material: Plástico
 Medida: 1.5 x 13.5 cm Bolígrafo / 5 cm Diámetro Spinner
 Área de Impresión: 1.2 x 3.5 cm
 Técnica de Impresión: Serigrafía
 Tinta: Negra
 Colores: A/B/R



Spinner de 1 balero. Mecanismo pulsador.





ZEGNO **SH 1255**
ESCRITURA

BOLÍGRAFO USB **LORIEN**

Material: Acero Inoxidable
 Medida: 1.3 x 14.5 cm
 Área de Impresión: 1 x 4 cm
 Técnica de Impresión: Grabado Espejo
 Capacidad: 4 GB
 Tinta: Negra
 Colores: Negro



Bolígrafo USB de 4 GB. Terminado rubber. Mecanismo twist. Incluye estuche.



ZEGNO **SH 1920**
ESCRITURA

BOLÍGRAFO USB **ELZ**

Material: Acero Inoxidable
 Medida: 1.4 x 13.8 cm
 Área de Impresión: 0.5 x 3 cm
 Técnica de Impresión: Láser / Serigrafía
 Capacidad: 8 GB
 Tinta: Negra
 Colores: Plata



Bolígrafo USB de 8 GB. Memoria USB con función OTG para transferencia de información entre dispositivos. Compatibilidad USB/Micro USB. Mecanismo twist. Incluye estuche.

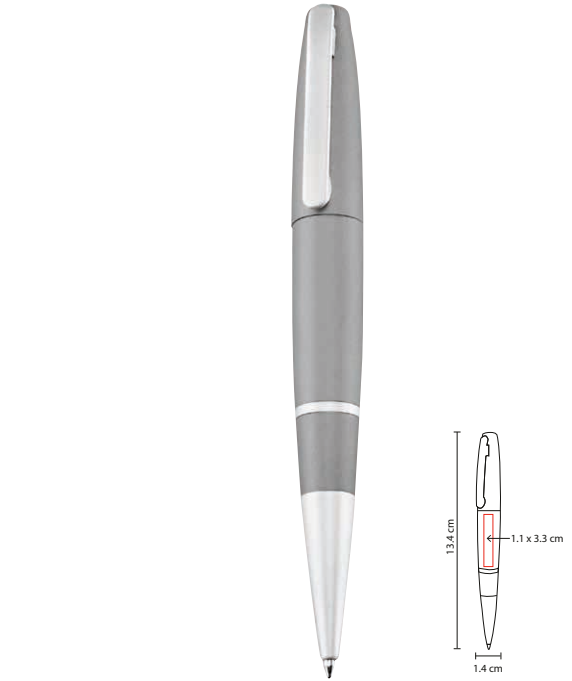

USB 05

BOLÍGRAFO USB **STERRA**

Material: Aleación Cobre
 Medida: 1.4 x 13.4 cm
 Área de Impresión: 1.1 x 3.3 cm
 Técnica de Impresión: Grabado Espejo / Serigrafía
 Capacidad: 4 GB
 Tinta: Negra
 Colores: Gris Oxford



Bolígrafo USB de 4 GB. Mecanismo twist. Incluye estuche y repuesto metálico.



B

ZEGNO® ■ SH 1940

ESCRITURA

BOLÍGRAFO USB EVANS

Material: Aluminio
 Medida: 1.1 x 14.5 cm
 Área de Impresión: 0.6 x 3.5 cm
 Técnica de Impresión: Láser / Serigrafía
 Capacidad: 8 GB
 Tinta: Negra
 Colores: B/G
 Colores GTM: B/G



G



Bolígrafo USB de 8 GB y touch screen. Mecanismo pulsador. Incluye estuche.

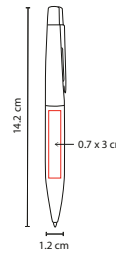

ZEGNO® ■ SH 2200

ESCRITURA

BOLÍGRAFO USB NEUSS

Material: Aleación Cobre / Plástico
 Medida: 1.2 x 14.2 cm
 Área de Impresión: 0.7 x 3 cm
 Técnica de Impresión: Grabado Espejo / Serigrafía
 Capacidad: 8 GB
 Tinta: Negra
 Colores: Gris



USB



Bolígrafo USB de 8 GB. Mecanismo twist. Incluye estuche.

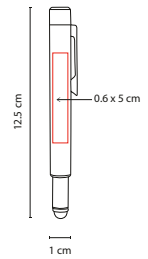
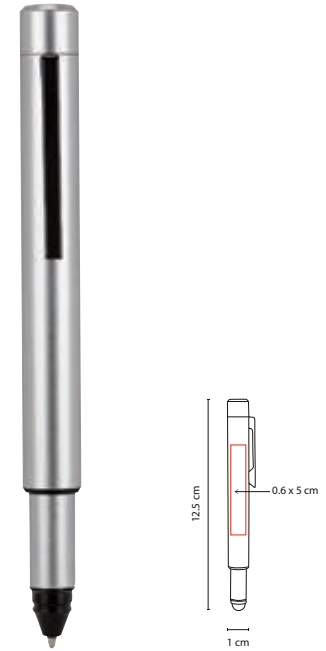

ZEGNO® ■ SH 1990

ESCRITURA

BOLÍGRAFO GUANA

Material: Aluminio
 Medida: 1 x 12.5 cm
 Área de Impresión: 0.6 x 5 cm
 Técnica de Impresión: Grabado Espejo / Serigrafía
 Capacidad: 8 GB
 Tinta: Negra
 Colores: Plata



Bolígrafo USB de 8 GB y touch screen. Incluye estuche.





P

ZEGNO ■ SH 1950
ESCRITURA

BOLÍGRAFO USB BORELY

Material: Plástico
 Medida: 1.4 x 14.5 cm
 Área de Impresión: 0.9 x 4.5 cm
 Técnica de Impresión: Serigrafía / Tampografía
 Capacidad: 4 GB
 Tinta: Negra
 Colores: A/B/M/O/P/R/V



O R B V A M

Bolígrafo USB de 4 GB. Mecanismo twist. Incluye estuche.



BOLÍGRAFO



LAPICERA



S

ZEGNO ■ EST 050
ESCRITURA

SET ARIZE

Material: Aluminio
 Medida: 1.3 x 14 cm
 Área de Impresión: 0.6 x 5 cm
 Técnica de Impresión: Láser / Serigrafía
 Tinta: Negra
 Colores: B/S
 Colores GTM: Plata



B

Bolígrafo y lapicera 0.5 mm. Mecanismo pulsador en clip. Incluye estuche.



BOLÍGRAFO LAPICERA

■ EST 040

SET CADMIO

Material: Aluminio / Curpiel
 Medida: 1 x 13.5 cm Bolígrafo / 4.2 x 14.5 cm Estuche
 Área de Impresión: 0.7 x 5 cm Bolígrafo /
 2.5 x 9 cm Estuche
 Técnica de Impresión: Láser / Serigrafía / Termograbado
 Tinta: Negra
 Colores: Negro
 Colores GTM: Negro



Bolígrafo y lapicera 0.5 mm. Mecanismo pulsador. Incluye estuche con imán para cerrado.

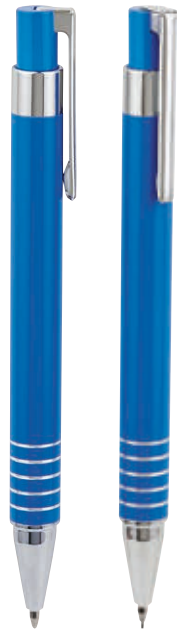

BOLÍGRAFO LAPICERA

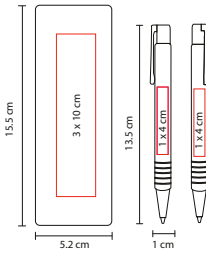

EST 015

SET COBALT

Material: Aluminio

Medida: 1 x 13.5 cm Bolígrafo / 5.2 x 15.5 cm Estuche

Área de Impresión: 1 x 4 cm Bolígrafo / 3 x 10 cm Estuche

Técnica de Impresión: Láser / Serigrafía

Tinta: Negra

Colores: A/B/R

Colores GTM: A/B/R



Bolígrafo y lapicera 0.5 mm. Mecanismo pulsador. Incluye estuche metálico.

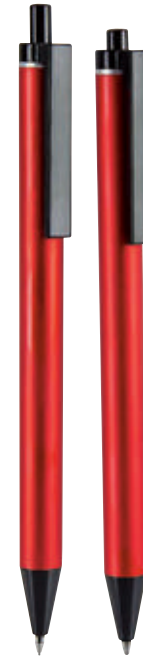

R

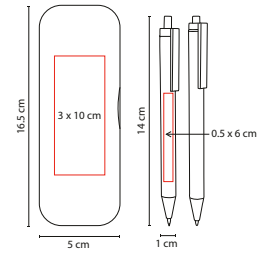

EST 025

SET LOFTY

Material: Aluminio / Plástico

Medida: 1 x 14 cm Bolígrafo / 5 x 16.5 cm Estuche

Área de Impresión: 0.5 x 6 cm Bolígrafo / 3 x 10 cm Estuche

Técnica de Impresión: Láser / Serigrafía

Tinta: Negra

Colores: A/G/R

Colores GTM: A/G/R



A

G

Bolígrafo y lapicera 0.5 mm. Mecanismo pulsador. Incluye estuche.



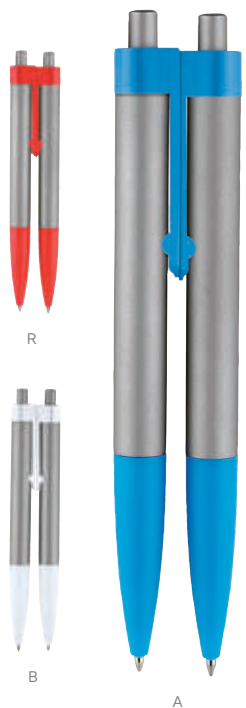

EST 060

SET ARLES

Material: Plástico
 Medida: 1.2 x 13.6 cm Bolígrafo /
 4 x 16.5 cm Estuche
 Área de Impresión: 0.5 x 4 cm Bolígrafo /
 2 x 10 cm Estuche
 Técnica de Impresión: Serigrafía
 Tinta: Negra
 Colores: A/B/R

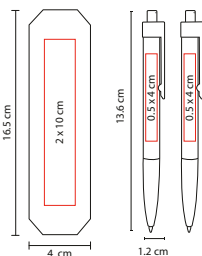

Bolígrafo y lapicera 0.5 mm.
 Mecanismo pulsador. Incluye estuche.



EST 030

SET DURHAM

Material: Plástico
 Medida: 0.9 x 12.6 cm Bolígrafo /
 6 x 14 cm Estuche
 Área de Impresión: 0.6 x 5.7 cm Bolígrafo /
 3.3 x 9.7 cm Estuche
 Técnica de Impresión: Serigrafía
 Tinta: Azul / Roja
 Colores: Blanco con Gris

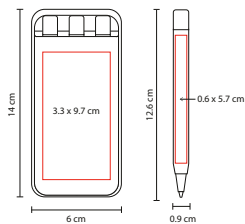

Incluye lapicera 0.5 mm y
 bolígrafos tinta azul y roja.



EST 070

SET MARKIEREN

Material: Plástico
 Medida: 2.2 x 5.5 cm Marcador /
 5.7 x 7 cm Estuche
 Área de Impresión: 1.5 x 2 cm Marcador /
 4 x 5 cm Estuche
 Técnica de Impresión: Serigrafía
 Colores: Blanco

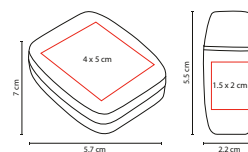

Marcatextos de cera. Incluye estuche.



SH 2145

MARCATEXTO FANORE

Material: Plástico
 Medida: 2 x 15.2 cm
 Área de Impresión: 1 x 6 cm
 Técnica de Impresión: Serigrafía
 Colores: Amarillo

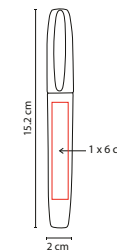



EST 035

ESTUCHE **GUAMA**

Material: Madera
 Medida: 1 x 13.6 cm Bolígrafo /
 4.7 x 17.2 cm Estuche
 Área de Impresión: 0.4 x 4 cm Bolígrafo /
 1.3 x 12 cm Estuche
 Técnica de Impresión: Láser / Serigrafía
 Tinta: Negra
 Colores: Beige

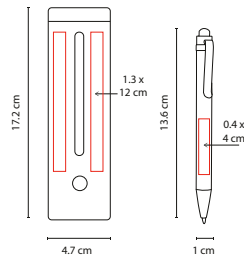

Bolígrafo y estuche de madera. Estuche con porta pluma y porta tarjetas.



EST 080

SET **VERNAL**

Material: Madera
 Medida: 1 x 13.7 cm
 Área de Impresión: 0.4 x 4 cm
 Técnica de Impresión: Láser / Serigrafía
 Tinta: Negra
 Colores: Beige

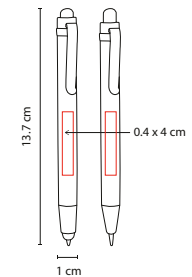

Bolígrafo con touch screen y lapicera 0.5 mm. Mecanismo pulsador. Incluye estuche.





A

ZEGNO®
ESCRITURA

■ RQ 700

BOLÍGRAFO ALLIER

Material: Aluminio

Medida: 1.3 x 13.8 cm

Área de Impresión: 0.7 x 3 cm

Técnica de Impresión: Láser / Serigrafía

Tinta: Negra

Colores: A/G/R

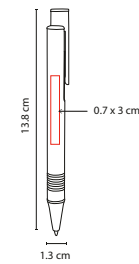

R



G

Mecanismo pulsador. Incluye funda.

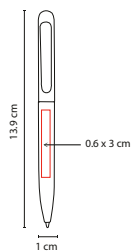

O

ZEGNO® ■ RQ 310

ESCRITURA

BOLÍGRAFO HAVEL

Material: Aluminio

Medida: 1 x 13.9 cm

Área de Impresión: 0.6 x 3 cm

Técnica de Impresión: Grabado Espejo / Serigrafía

Tinta: Negra

Colores: A/B/N/O/R



N

A

B

R

Mecanismo twist para ocultar el clip. Incluye funda.

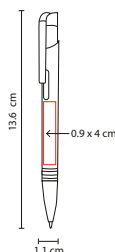

N

ZEGNO® ■ SH 1470

ESCRITURA

BOLÍGRAFO AZIZA

Material: Aluminio

Medida: 1.1 x 13.6 cm

Área de Impresión: 0.9 x 4 cm

Técnica de Impresión: Láser / Pantógrafo

Tinta: Negra

Colores: A/B/N/R

Colores GTM: A/B/N/R



B

A

R

Mecanismo pulsador. Incluye estuche transparente.

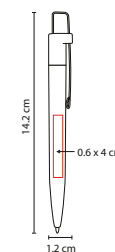

B

ZEGNO® ■ SH 2620

ESCRITURA

BOLÍGRAFO VANIR

Material: Aluminio

Medida: 1.2 x 14.2 cm

Área de Impresión: 0.6 x 4 cm

Técnica de Impresión: Grabado Espejo / Serigrafía

Tinta: Negra

Colores: A/B/R



R

A

Mecanismo pulsador. Incluye estuche.





B

ZEGNO®
ESCRITURA

■ SH 1245

BOLÍGRAFO RIGA

Material: Acero Inoxidable

Medida: 1 x 13.5 cm

Área de Impresión: 0.6 x 5 cm

Técnica de Impresión: Grabado Espejo / Serigrafía

Tinta: Negra

Colores: B/R Sólidos / A/N/S Metalizados

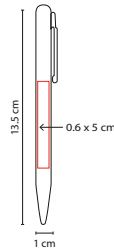

N

S

A

R

Mecanismo twist. Incluye funda.



O

ZEGNO®
ESCRITURA

■ SH 1210

BOLÍGRAFO GALI

Material: Acero Inoxidable

Medida: 1.2 x 14 cm

Área de Impresión: 0.9 x 3.7 cm

Técnica de Impresión: Grabado Espejo / Serigrafía

Tinta: Negra

Colores: A/M/O/R/S/V/Y

Colores GTM: M/O/V

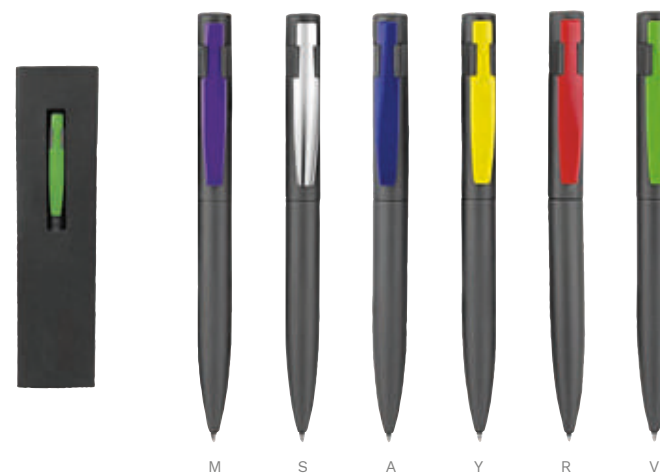
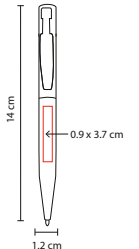

M

S

A

Y

R

V

Mecanismo twist. Incluye estuche.



S

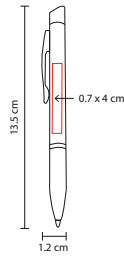

■ SH 1370

BOLÍGRAFO ACRUX

Material: Aluminio
Medida: 1.2 x 13.5 cm
Área de Impresión: 0.7 x 4 cm
Técnica de Impresión: Láser / Serigrafía
Tinta: Negra
Colores: A/B/R/S



B

R

A

Bolígrafo con punta para agenda electrónica (no touch screen) y grip antiderrapante. Mecanismo twist. Incluye estuche transparente.



A

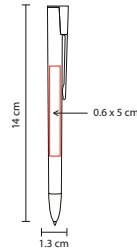

ZEGNO® ■ RQ 400

BOLÍGRAFO LYON

Material: Aluminio
Medida: 1.3 x 14 cm
Área de Impresión: 0.6 x 5 cm
Técnica de Impresión: Láser / Serigrafía
Tinta: Negra
Colores: A/B/R



R

B

Mecanismo pulsador. Incluye funda.



R

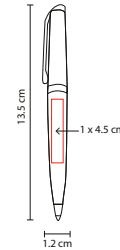

■ RQ 205

BOLÍGRAFO NEVSKY

Material: Acero Inoxidable
Medida: 1.2 x 13.5 cm
Área de Impresión: 1 x 4.5 cm
Técnica de Impresión: Grabado Espejo
Tinta: Negra
Colores: A/B/N/R/S



S

A

B

N

Mecanismo twist. Incluye funda.





R

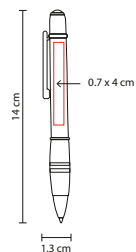

■ SH 1295

BOLÍGRAFO BOSTON

Material: Aleación Cobre

Medida: 1.3 x 14 cm

Área de Impresión: 0.7 x 4 cm

Técnica de Impresión: Grabado Espejo / Láser / Serigrafía

Tinta: Negra

Colores: A/N/R/S



N

S

A

Grip antiderrapante. Mecanismo twist. Incluye estuche.



G

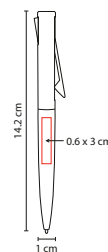

■ SH 2625

BOLÍGRAFO COS

Material: Aluminio

Medida: 1 x 14.2 cm

Área de Impresión: 0.6 x 3 cm

Técnica de Impresión: Grabado Espejo / Serigrafía

Tinta: Negra

Colores: A/G/S

Colores GTM: A/G/S

ZEGNO®
ESCRITURA



S

A

Mecanismo pulsador. Incluye estuche.



N

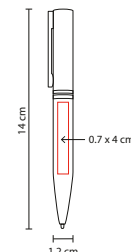

■ SH 1260

BOLÍGRAFO MAO

Material: Acero Inoxidable

Medida: 1.2 x 14 cm

Área de Impresión: 0.7 x 4 cm

Técnica de Impresión: Grabado Espejo

Tinta: Negra

Colores: A/N

ZEGNO®
ESCRITURA



A

Terminado rubber. Mecanismo twist. Incluye estuche.



S

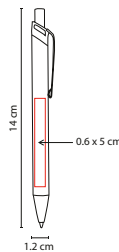

■ RQ 016

BOLÍGRAFO ORISSA

Material: Aluminio

Medida: 1.2 x 14 cm

Área de Impresión: 0.6 x 5 cm

Técnica de Impresión: Láser / Serigrafía

Tinta: Azul

Colores: D/G/S



G

D

Mecanismo pulsador. Incluye estuche.



G

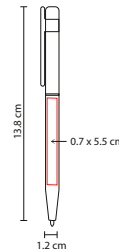

ZEGNO® ■ RQ 600

ESCRITURA

BOLÍGRAFO BARETI

Material: Aleación Cobre

Medida: 1.2 x 13.8 cm

Área de Impresión: 0.7 x 5.5 cm

Técnica de Impresión: Grabado Espejo / Serigrafía

Tinta: Negra

Colores: B/G/S

Colores GTM: G/S



B

S

Mecanismo twist. Incluye funda.



D

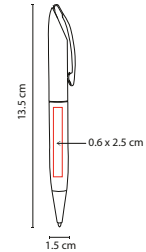

ZEGNO® ■ SH 2710

ESCRITURA

BOLÍGRAFO LESATH

Material: Aluminio

Medida: 1.5 x 13.5 cm

Área de Impresión: 0.6 x 2.5 cm

Técnica de Impresión: Láser / Serigrafía

Tinta: Negra

Colores: D/G/S



S

G

Mecanismo twist. Incluye funda.





S

SH 5500

BOLÍGRAFO BEKER

Material: Acero Inoxidable
 Medida: 1.2 x 13.5 cm
 Área de Impresión: 0.7 x 4.2 cm
 Técnica de Impresión: Grabado Espejo / Serigrafía
 Tinta: Negra
 Colores: N/S
 Colores GTM: N/S



N

Mecanismo twist. Incluye estuche.



SH 2630

BOLÍGRAFO UKKO

Material: Acero Inoxidable
 Medida: 0.9 x 13.1 cm
 Área de Impresión: 0.5 x 3.5 cm
 Técnica de Impresión: Láser / Serigrafía
 Tinta: Negra
 Colores: Plata
 Colores GTM: Plata



Mecanismo pulsador.



G

RQ 020

BOLÍGRAFO MAGOTTY

Material: Aluminio
 Medida: 1.3 x 13.7 cm
 Área de Impresión: 0.7 x 4 cm Barril / 0.9 cm Diámetro
 Técnica de Impresión: Goteado en Resina / Grabado Espejo / Serigrafía
 Tinta: Azul
 Colores: G/S
 Colores GTM: G/S



S

Mecanismo twist. Incluye estuche.



N

RQ 015

BOLÍGRAFO LESTER

Material: Acero Inoxidable
 Medida: 1.2 x 12.1 cm
 Área de Impresión: 0.7 x 4 cm
 Técnica de Impresión: Grabado Espejo / Serigrafía
 Tinta: Negra
 Colores: N/S



S

Mecanismo twist. Incluye estuche.

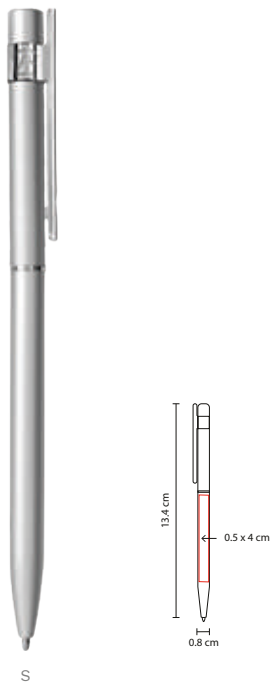

S

ZEGNO® ■ SH 1280

BOLÍGRAFO ERIE

Material: Aleación Cobre

Medida: 0.8 x 13.4 cm

Área de Impresión: 0.5 x 4 cm

Técnica de Impresión: Grabado Espejo / Serigrafía

Tinta: Negra

Colores: B/G/N/S



N

B

G

Mecanismo twist. Incluye funda.



ZEGNO® ■ RQ 019

BOLÍGRAFO DALLAS

Material: Acero Inoxidable

Medida: 1.4 x 12.8 cm

Área de Impresión: 1 x 4 cm

Técnica de Impresión: Grabado Espejo / Serigrafía

Tinta: Negra

Colores: Negro

Colores GTM: Negro



Mecanismo twist. Incluye estuche imantado.



ZEGNO® ■ SH 2610

BOLÍGRAFO SENY

Material: Acero Inoxidable

Medida: 1.3 x 13.5 cm

Área de Impresión: 0.7 x 4 cm

Técnica de Impresión: Grabado Espejo / Serigrafía

Tinta: Negra

Colores: Negro



Mecanismo twist. Incluye estuche.





■ RQ 008

BOLÍGRAFO **EVEREST**

Material: Aleación Cobre
Medida: 1 x 10.7 cm

Área de Impresión: 0.8 x 2.5 cm

Técnica de Impresión: Grabado Espejo /
Serigrafía

Tinta: Negra
Colores: Negro



Mecanismo twist. Incluye estuche.



■ RQ 021

BOLÍGRAFO **NAVAGIO**

Material: Acero Inoxidable
Medida: 1.2 x 14 cm

Área de Impresión: 0.8 x 4 cm

Técnica de Impresión: Grabado Espejo

Tinta: Negra

Colores: Negro

ZEGNO[®]
ESCRITURA



Terminado rubber.
Mecanismo twist. Incluye estuche.



■ SH 1275

BOLÍGRAFO **DURBAN**

Material: Acero Inoxidable
Medida: 1 x 13.8 cm

Área de Impresión: 0.7 x 3 cm

Técnica de Impresión: Grabado Espejo /
Serigrafía

Tinta: Negra
Colores: B/G/N

Colores GTM: B/G/N

ZEGNO[®]
ESCRITURA



N B

Mecanismo twist. Incluye estuche.

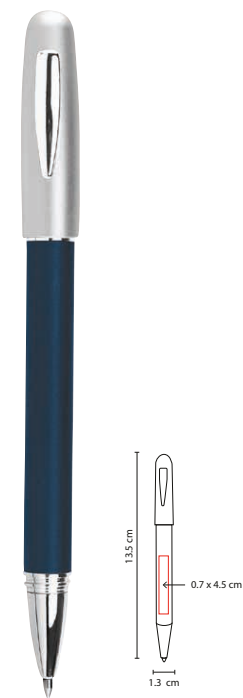

■ RQ 1003

BOLÍGRAFO **ROLLER BALL**

Material: Acero Inoxidable
Medida: 1.3 x 13.5 cm

Área de Impresión: 0.7 x 4.5 cm

Técnica de Impresión: Grabado Espejo

Tinta: Negra

Colores: Azul



Bolígrafo con tapón. Terminado rubber.
Incluye estuche.

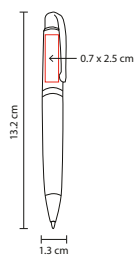

A

■ SH 1355

BOLÍGRAFO BURDEOS

Material: Acero Inoxidable

Medida: 1.3 x 13.2 cm

Área de Impresión: 0.7 x 2.5 cm

Técnica de Impresión: Láser / Pantógrafo

Tinta: Negra

Colores: A/N



N

Grip antiderrapante. Mecanismo twist. Incluye estuche imantado.

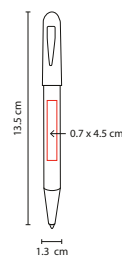

13.5 cm

1.3 cm

■ RQ 1002

BOLÍGRAFO ROLLER BALL

Material: Acero Inoxidable

Medida: 1.3 x 13.5 cm

Área de Impresión: 0.7 x 4.5 cm

Técnica de Impresión: Grabado Espejo

Tinta: Negra

Colores: Negro



Bolígrafo con tapón. Terminado rubber. Incluye estuche.

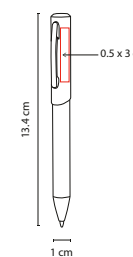

13.4 cm

1 cm

ZEGNO®
ESCRITURA

■ RQ 030

BOLÍGRAFO CHINOOK

Material: Aleación Cobre

Medida: 1 x 13.4 cm

Área de Impresión: 0.5 x 3 cm

Técnica de Impresión: Grabado Espejo / Serigrafía

Tinta: Negra

Colores: Negro



Mecanismo twist. Incluye estuche.





■ RQ 215

BOLÍGRAFO ARANYK

Material: Acero Inoxidable
 Medida: 1.3 x 14 cm
 Área de Impresión: 0.8 x 3 cm
 Técnica de Impresión: Grabado Espejo / Serigrafía
 Tinta: Negra
 Colores: Plata

ZEGNO®
 ESCRITURA



Mecanismo twist. Incluye estuche.



■ RQ 017

BOLÍGRAFO COLUMBUS

Material: Aleación Cobre / Fibra de Carbono
 Medida: 1.2 x 14 cm
 Área de Impresión: 0.7 x 5 cm
 Técnica de Impresión: Serigrafía
 Tinta: Negra
 Colores: Gris

ZEGNO®
 ESCRITURA



Mecanismo twist. Incluye estuche.



■ RQ 1006

BOLÍGRAFO LACOCK

Material: Acero Inoxidable
 Medida: 1.2 x 13.5 cm
 Área de Impresión: 0.7 x 3 cm
 Técnica de Impresión: Láser / Serigrafía
 Tinta: Negra
 Colores: Gris

ZEGNO®
 ESCRITURA



Bolígrafo roller ball con tapón. Incluye estuche.



■ RQ 012

BOLÍGRAFO PARLEE

Material: Aleación Cobre / Fibra de Carbono
 Medida: 1.2 x 13.8 cm
 Área de Impresión: 0.7 x 4 cm
 Técnica de Impresión: Serigrafía
 Tinta: Negra
 Colores: Negro

ZEGNO®
 ESCRITURA



Mecanismo pulsador. Incluye estuche.

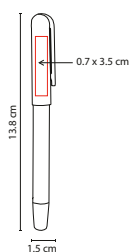

■ RQ 1009

BOLÍGRAFO HOUSTON

Material: Aluminio

Medida: 1.5 x 13.8 cm

Área de Impresión: 0.7 x 3.5 cm

Técnica de Impresión: Grabado Espejo / Serigrafía

Tinta: Negra

Colores: G/S

Z E G N O[®]
E S C R I T U R A



S

G



Bolígrafo roller ball con tapón. Incluye estuche.

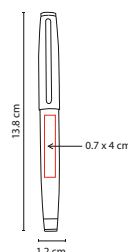

N

■ RQ 1007

BOLÍGRAFO SURIN

Material: Acero Inoxidable

Medida: 1.2 x 13.8 cm

Área de Impresión: 0.7 x 4 cm

Técnica de Impresión: Grabado Espejo / Serigrafía

Tinta: Negra

Colores: G/N

Z E G N O[®]
E S C R I T U R A



G

Bolígrafo roller ball con tapón. Incluye estuche.

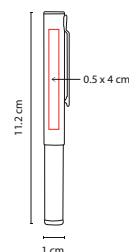

■ RQ 040

BOLÍGRAFO AERO

Material: Aleación Cobre / Aluminio

Medida: 1 x 11.2 cm

Área de Impresión: 0.5 x 4 cm

Técnica de Impresión: Láser / Serigrafía

Tinta: Negra

Colores: Gris

Z E G N O[®]
E S C R I T U R A



Bolígrafo roller ball con tapón magnético. Incluye estuche.



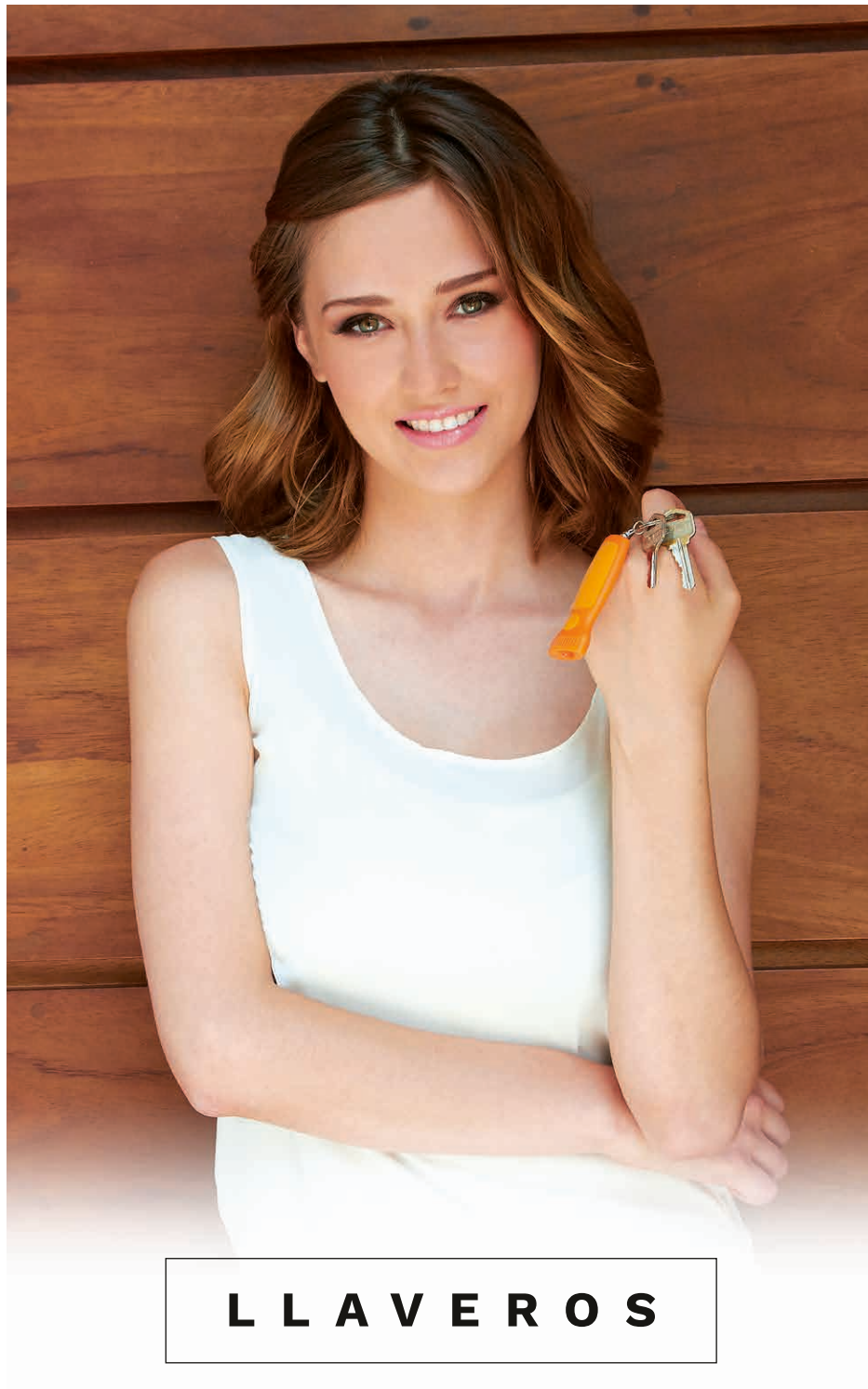

LLAVEROS



A

■ **K 700**

LLAVERO COCHINITO

Material: Plástico
 Medida: 2.4 x 2.5 cm
 Área de Impresión: 1 x 0.8 cm
 Técnica de Impresión: Tampografía
 Colores: A/R/V
 Colores GTM: A/R/V

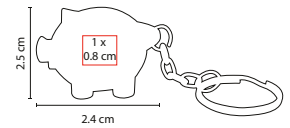

V



R



■ PRO 002

MINI LLAVERO FLEXÓMETRO

Material: Plástico
 Medida: 3.9 x 10.4 cm
 Área de Impresión: 2.7 x 3.3 cm
 Técnica de Impresión: Serigrafía
 Colores: Blanco
 ■ ■ Colores GTM: Blanco

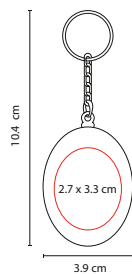

Cinta metálica de 1 m.



■ PRO 034

LLAVERO FLEXÓMETRO CASITA

Material: Plástico
 Medida: 4.5 x 10.1 cm
 Área de Impresión: 3.9 x 2.4 cm
 Técnica de Impresión: Serigrafía
 Colores: Blanco
 ■ ■ Colores GTM: Blanco

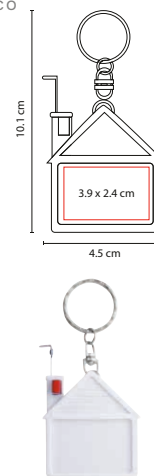

Cinta metálica de 1 m.



■ K 650

LLAVERO HESSE

Material: Plástico
 Medida: 3.5 x 3.7 cm
 Área de Impresión: 2.3 cm Diámetro
 Técnica de Impresión: Serigrafía
 Colores: A/N/R

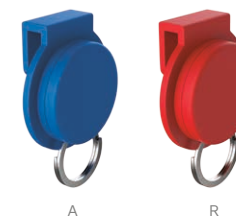
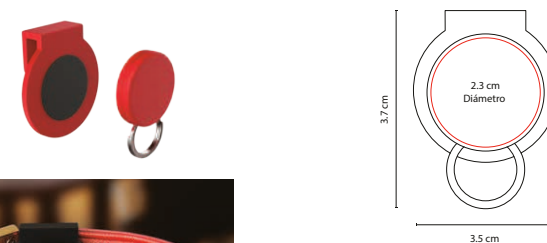

Sujetador de llaves para bolsa con imán.



PRO 016

LLAVERO FLEXÓMETRO CAMIÓN

Material: Plástico
 Medida: 5.5 x 4 cm
 Área de Impresión: 2.7 x 1.9 cm
 Técnica de Impresión: Serigrafía
 Colores: Blanco

Colores GTM: Blanco

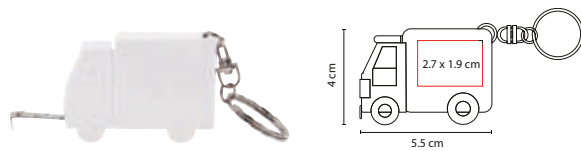

Cinta metálica de 1 m.



PRO 005

LLAVERO FLEXÓMETRO WHEEL

Material: Plástico
 Medida: 5.3 x 10.4 cm
 Área de Impresión: 2.9 cm Diámetro
 Técnica de Impresión: Goteado en Resina
 Colores: A/N/R



Cinta flexible de plástico de 1.5 m.



K 100

LLAVERO ANTI-STRESS

Material: PU
 Medida: 3.7 x 8.9 cm
 Área de Impresión: 2.5 cm Diámetro
 Técnica de Impresión: Tampografía
 Colores: A/R/S

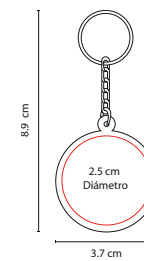

Llavero con pelota anti-stress.



V

■ PRO 008

LLAVERO FLEXÓMETRO OVALADO

Material: Plástico

Medida: 4.7 x 12 cm

Área de Impresión: 3.4 x 4 cm

Técnica de Impresión: Serigrafía

Colores: AT/RT Translúcidos / B/O/V/Y Sólidos

■ ■ Colores GTM: AT/RT Translúcidos / B/V Sólidos

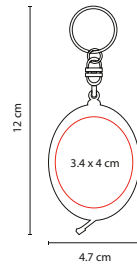

Cinta flexible de plástico de 1.5 m.



R

■ PRO 018

LLAVERO FLEXÓMETRO MEASURE

Material: Plástico

Medida: 3.7 x 4 cm

Área de Impresión: 2.5 x 2.5 cm

Técnica de Impresión: Serigrafía

Colores: A/B/R

■ ■ Colores GTM: A/B/R

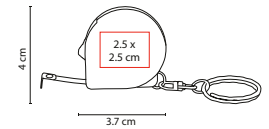

Cinta metálica de 1 m.



A

■ DPO 030

LLAVERO DESTAPADOR KINZIG

Material: Plástico
 Medida: 3.1 x 12.3 cm
 Área de Impresión: 2 x 3 cm
 Técnica de Impresión: Serigrafía
 Colores: A/N/R

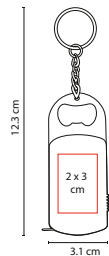

N



R

Llavero destapador con lámpara de 1 LED. Cinta metálica 1 m.



B

■ M 2010

LLAVERO CON LUZ KAMSAR

Material: Plástico
 Medida: 3 x 6.5 cm
 Área de Impresión: 2 x 4 cm
 Técnica de Impresión: Serigrafía
 Colores: A/B/O/R/V
 ■ ■ Colores GTM: A/B/O/R/V

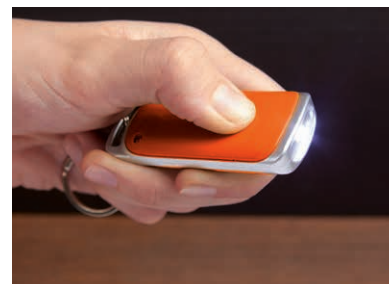
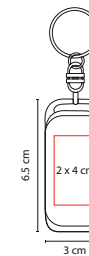

V



R



A



O

Llavero con luz de 1 LED. Incluye batería.



A

■ M 2015

LLAVERO CON LUZ BOKÉ

Material: Plástico
 Medida: 4 cm Diámetro
 Área de Impresión: 3.5 cm Diámetro
 Técnica de Impresión: Serigrafía
 Colores: A/B/R/V



4 cm Diámetro



B



R



V

Llavero con luz de 1 LED. Incluye batería.



R

■ K 400

LLAVERO CON LUZ ORDINO

Material: Plástico
 Medida: 3.7 x 7.4 cm
 Área de Impresión: 2.5 x 2 cm
 Técnica de Impresión: Serigrafía
 Colores: A/N/R

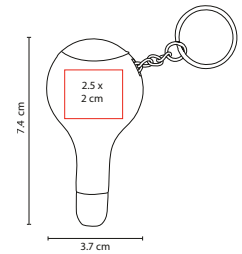

7.4 cm

3.7 cm



N



A

Llavero con luz y 2 puntas para desarmador (cruz y plano). Incluye baterías.



A

■ M 2065

LLAVERO CON LUZ **DASSEL**

Material: Plástico
 Medida: 3.5 x 3.7 cm
 Área de Impresión: 2.7 x 1.2 cm
 Técnica de Impresión: Serigrafía
 Colores: A/R

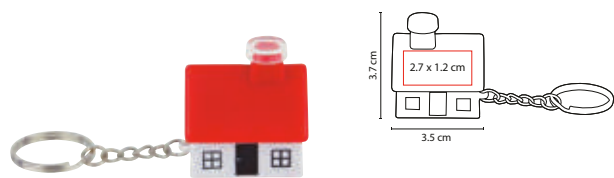

R



Llavero con luz de 1 LED. Mecanismo pulsador. Incluye batería.



G

■ M 2055

LLAVERO CON LUZ **WILTZ**

Material: Plástico
 Medida: 3.4 x 9.2 cm
 Área de Impresión: 1.5 x 1 cm
 Técnica de Impresión: Serigrafía
 Colores: A/G/R



A

R



Llavero con lámpara 1 LED. Incluye baterías.



■ SOC 095

LLAVERO CON LUZ **SPORT**

Material: Plástico
 Medida: 5 x 6 cm
 Área de Impresión: 1.5 x 3 cm
 Técnica de Impresión: Serigrafía
 Colores: Blanco

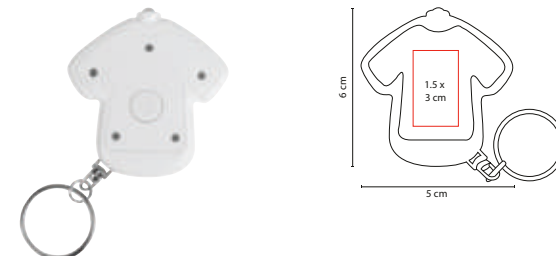

Llavero con luz. Incluye batería.



O

■ M 4010

LLAVERO CON LUZ **SENY**

Material: Plástico

Medida: 3 x 7.6 cm

Área de Impresión: 1.5 x 3.5 cm

Técnica de Impresión: Serigrafía / Tampografía

Colores: A/N/O/P/R/V

Colores GTM: A/P/R/V

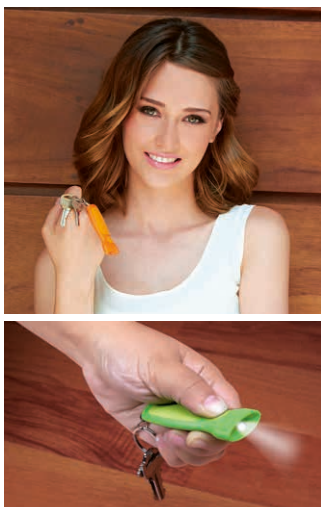
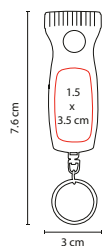

V

R

A

N

P

Llavero lámpara bitono de 1 LED. Incluye batería.



R

■ K 231

LLAVERO CON LUZ **CASTEL**

Material: Plástico

Medida: 2.8 x 10 cm

Área de Impresión: 1.2 x 3.7 cm

Técnica de Impresión: Serigrafía

Colores: A/N/R

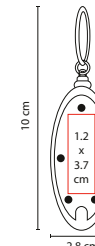

N



A

Llavero con luz. Incluye batería.



■ DPO 020

LLAVERO DESTAPADOR CON LUZ **STADIUM**

Material: Plástico
 Medida: 3.8 x 12.2 cm
 Área de Impresión: 2.1 x 2.7 cm
 Técnica de Impresión: Serigrafía
 Colores: A/N/R/V
 ■ ■ Colores GTM: A/N/R/V

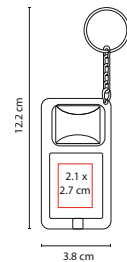

Incluye 2 baterías de botón.



■ DPO 022

LLAVERO DESTAPADOR **HELMET**

Material: Plástico
 Medida: 6.2 x 3.2 cm
 Área de Impresión: 4.5 x 3.5 cm
 Técnica de Impresión: Serigrafía
 Colores: A/B/R/Y

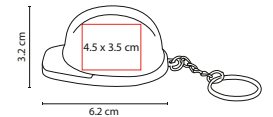

Llavero con destapador.



R

■ LAM 050

LÁMPARA DESTAPADOR LEO

Material: Aluminio
Medida: 2 x 7.2 cm

Área de Impresión: 1.5 x 2.7 cm

Técnica de Impresión: Láser / Pantógrafo / Serigrafía

Colores: A/R/S

■ ■ Colores GTM: A/R/S

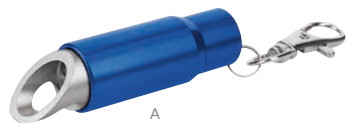
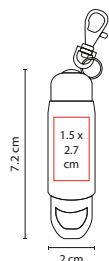

A



S



A

■ DPO 024

LLAVERO TIATU

Material: Aluminio
Medida: 1.4 x 9.5 cm

Área de Impresión: .8 x 6 cm

Técnica de Impresión: Serigrafía

Colores: A/N/R/S

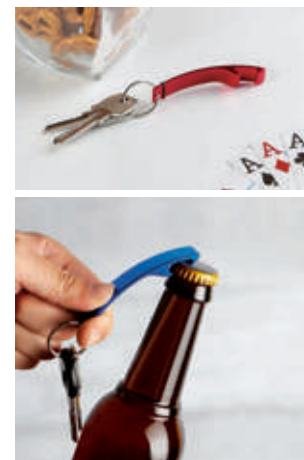
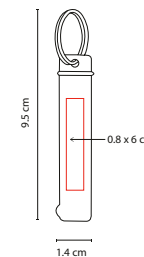

S

N

R

Llavero destapador.

3 LEDs. Incluye gancho, destapador, cuña abrelatas y batería de botón.





N

■ DPO 001

LLAVERO DESTAPADOR **LANCE**

Material: Plástico

Medida: 2.1 x 9.2 cm

Área de Impresión: 1.5 x 3 cm

Técnica de Impresión: Serigrafía

Colores: A/N/R/V/Y Translúcidos / Blanco Sólido

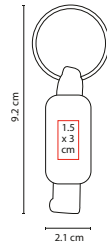

Y

V

B

R

A

Llavero destapador.



O

■ DPO 015

LLAVERO DESTAPADOR **BERMUDA**

Material: Plástico

Medida: 1.7 x 12.3 cm

Área de Impresión: 1.2 x 2.4 cm

Técnica de Impresión: Serigrafía

Colores: A/B/O/R/V/Y

■ Colores GTM: A/B/O/R/V/Y

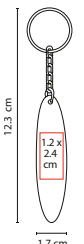

R

Y

A

B

V

Llavero destapador.



B

■ DPO 012

LLAVERO DESTAPADOR **KLEIN**

Material: Plástico

Medida: 3.3 x 9.1 cm

Área de Impresión: 1.8 x 3.8 cm

Técnica de Impresión: Serigrafía

Colores: A/R Translúcidos / Blanco Sólido

■ Colores GTM: A/R Translúcidos / Blanco Sólido



A



R

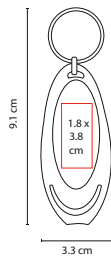

Incluye cuña para abrir latas.



■ DPO 050

LLAVERO DESTAPADOR **TELSEN**

Material: Metal

Medida: 3.3 x 9.6 cm

Área de Impresión: 2 x 1.8 cm

Técnica de Impresión: Grabado Espejo / Serigrafía

Colores: Gris

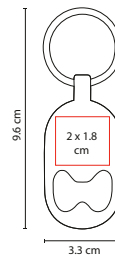

Llavero destapador.



■ DPO 023

LLAVERO DESTAPADOR **PHOENIX**

Material: Curpiel / Metal

Medida: 3.6 x 9.2 cm

Área de Impresión: 2.2 x 5.1 cm Curpiel /

Metal 2.5 x 1.8 cm

Técnica de Impresión: Termograbado / Láser

Colores: Negro

■ Colores GTM: Negro

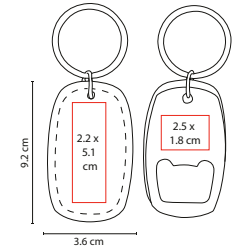

Llavero con destapador. Incluye caja individual.





N

M 4180

LLAVERO GLASDTONE

Material: Metal / Tela

Medida: 3.3 x 11 cm

Área de Impresión: 1.9 x 2 cm

Técnica de Impresión: Láser en Placa Metálica

Colores: A/N/R/V

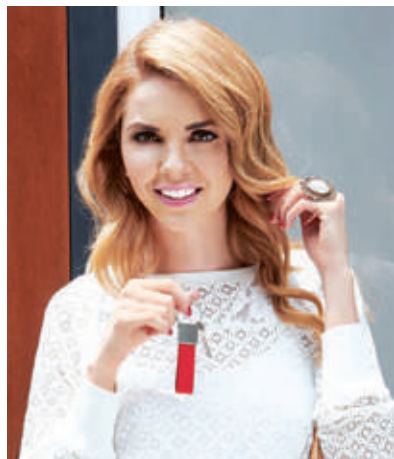
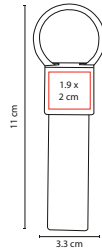

A



R



V

Incluye caja individual.



R

M 3000

LLAVERO ASIS

Material: Curpiel / Metal

Medida: 2 x 9.4 cm

Área de Impresión: 1.3 x 2 cm

Técnica de Impresión: Láser

Colores: A/C/N/R

Colores GTM: A/N/R

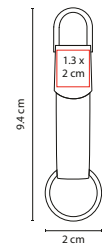

N



A



C

Llavero con gancho. Incluye caja individual.



A

■ M 2310

LLAVERO **DARINI**

Material: Metal
 Medida: 3.4 x 7.5 cm
 Área de Impresión: 2.1 cm Diámetro
 Técnica de Impresión: Goteado en Resina / Láser
 Colores: A/N/R

■ ■ Colores GTM: A/N/R



R

■ M 6850

LLAVERO **SURAT**

Material: Hule / Metal
 Medida: 3.5 x 8.4 cm
 Área de Impresión: 2.5 x 1.5 cm
 Técnica de Impresión: Láser
 Colores: A/N/R

■ ■ Colores GTM: A/N/R



■ M 2035

LLAVERO **LEGACY**

Material: Curpiel / Metal
 Medida: 3 x 8.5 cm
 Área de Impresión: 2 x 1.5 cm
 Técnica de Impresión: Láser / Pantógrafo
 Colores: Negro

■ ■ Colores GTM: Negro

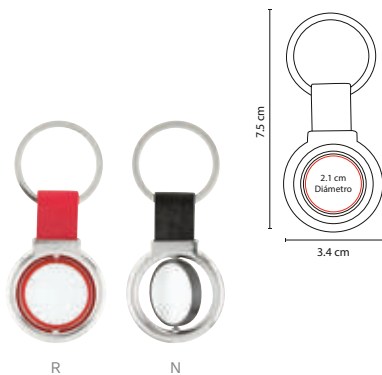
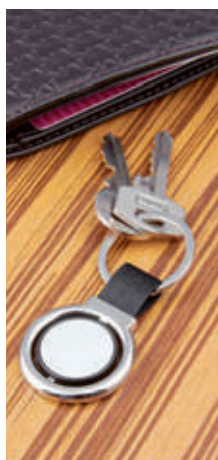

R

N

Incluye caja individual.



N

A

Incluye caja individual.

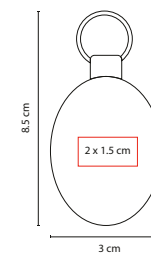
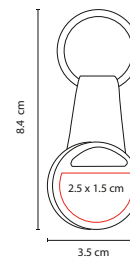

Incluye caja individual.





■ **M 5813**

LLAVERO CASPIO

Material: Metal / Tela
 Medida: 2.8 x 8 cm
 Área de Impresión: 2.2 x 2.5 cm
 Técnica de Impresión: Pantógrafo / Serigrafía
 Colores: A/N/R/V/Y
 Colores GTM: A/N/R/V/Y

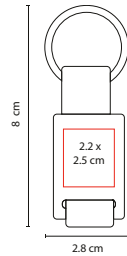

A

N

R

V

Incluye caja individual.



■ **M 2108**

LLAVERO VOLGA

Material: Hule / Metal
 Medida: 2.8 x 8 cm
 Área de Impresión: 2.4 x 2.4 cm
 Técnica de Impresión: Grabado Espejo / Serigrafía
 Colores: A/O/N/R/V

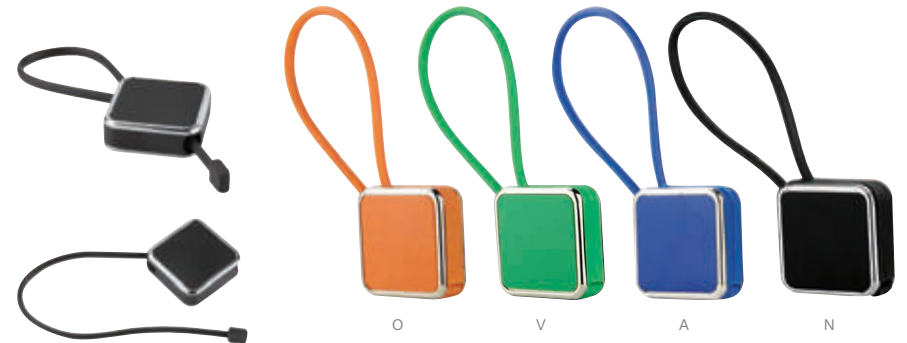
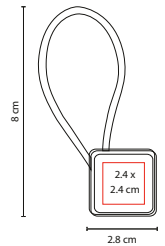

O

V

A

N

Incluye caja individual.



A

■ M 3400

LLAVERO MINDEL

Material: Curpiel / Metal

Medida: 4.1 x 9.4 cm

Área de Impresión: 2 x 2.5 cm

Técnica de Impresión: Láser / Serigrafía / Termograbado

Colores: A/N/R

📦 Colores GTM: A/N/R

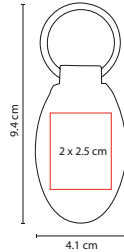

R



N

Incluye caja individual.



R

■ M 3450

LLAVERO BURU

Material: Curpiel / Metal

Medida: 3.2 x 9.1 cm

Área de Impresión: 1.5 x 3.5 cm

Técnica de Impresión: Láser / Serigrafía / Termograbado

Colores: A/N/R

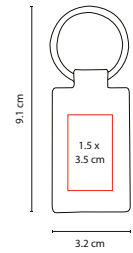

A



N

Incluye caja individual.





01

02

M 63287

LLAVERO SVART

Material: Curpiel / Metal
 Medida: 3 x 9 cm
 Área de Impresión: 1.4 x 2.5 cm
 Técnica de Impresión: Serigrafía
 Colores: Negro

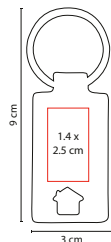
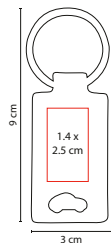

Incluye caja individual.



M 3100

LLAVERO ARUM

Material: Curpiel / Metal
 Medida: 1.8 x 9.5 cm
 Área de Impresión: 1 x 1.5 cm
 Técnica de Impresión: Láser
 Colores: Negro

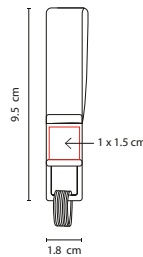

Incluye 4 arillos y estuche especial.



M 63286

LLAVERO ALDAN

Material: Curpiel / Metal
 Medida: 3.5 x 9.8 cm
 Área de Impresión: 1 x 3 cm
 Técnica de Impresión: Láser
 Colores: Negro
 Colores GTM: Negro

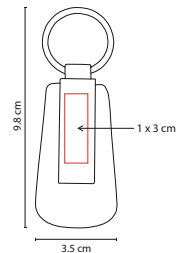

Incluye caja individual.



■ M 2085

LLAVERO GERSOPPA

Material: Curpiel / Metal
 Medida: 2.7 x 9.6 cm
 Área de Impresión: 1.3 x 2.3 cm
 Técnica de Impresión: Serigrafía
 Colores: Negro
 Colores GTM: Negro

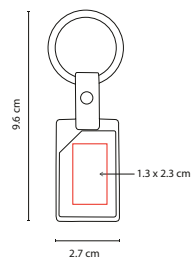

Incluye caja individual.



c

■ M 3550

LLAVERO BANGKA

Material: Curpiel
 Medida: 2.2 x 14 cm
 Área de Impresión: 1 x 8.5 cm
 Técnica de Impresión: Serigrafía
 Colores: C/N

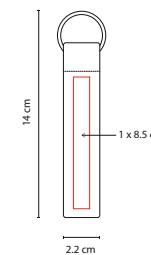

N





■ M 4050

LLAVERO SOKAR

Material: Metal / Curpiel
 Medida: 2.5 x 12.5 cm
 Área de Impresión: 2.1 cm Diámetro
 Técnica de Impresión: Goteado en Resina / Láser
 Colores: Negro

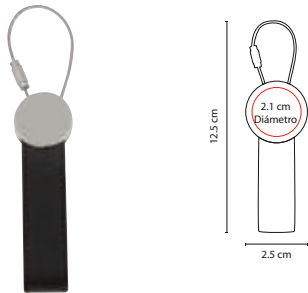

Incluye caja individual.



■ M 4060

LLAVERO NOX

Material: Metal / Curpiel
 Medida: 2.5 x 12.5 cm
 Área de Impresión: 2.2 x 2.2 cm
 Técnica de Impresión: Goteado en Resina / Láser
 Colores: Negro

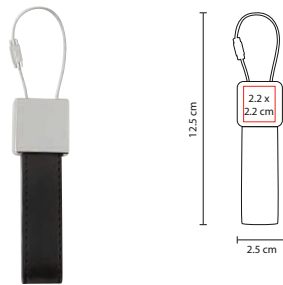

Incluye caja individual.



■ M 3500

LLAVERO ARKADI

Material: Metal
 Medida: 3 x 8 cm
 Área de Impresión: 2 cm Diámetro
 Técnica de Impresión: Láser
 Colores: Negro



Incluye 2 arillos y estuche especial.



■ M 2020

LLAVERO CASA RUMA

Material: Curpiel / Metal
 Medida: 4.4 x 7.5 cm
 Área de Impresión: 2.5 x 1.5 cm
 Técnica de Impresión: Láser
 Colores: Negro

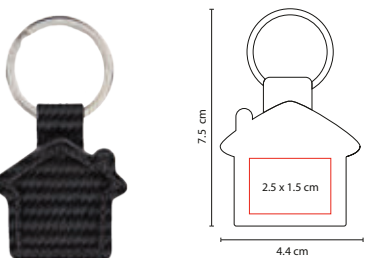

Incluye caja individual.



■ M 2050

LLAVERO PUERQUITO CON PLACA

Material: Hule / Metal
 Medida: 2.5 x 7 cm Llavero /
 3 x 1.4 cm Placa
 Área de Impresión: 1 x 0.5 cm Llavero /
 2 x 0.7 cm Placa
 Técnica de Impresión: Láser / Pantógrafo
 Colores: Negro

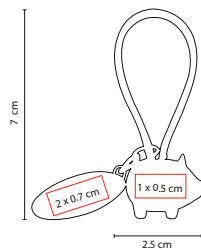

Incluye placa metálica para grabado y caja individual.



■ M 2060

LLAVERO CASA CON PLACA

Material: Hule / Metal
 Medida: 2.8 x 7 cm Llavero /
 3 x 1.4 cm Placa
 Área de Impresión: 1.2 x 1.5 cm Llavero /
 2 x 0.7 cm Placa
 Técnica de Impresión: Láser / Pantógrafo
 Colores: Negro

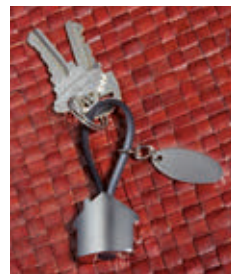
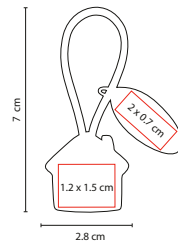

Incluye placa metálica para grabado y caja individual.



■ M 2070

LLAVERO PERSONA CON PLACA

Material: Hule / Metal
 Medida: 2.7 x 7.5 cm Llavero /
 3 x 1.4 cm Placa
 Área de Impresión: 0.6 x 1.7 cm Llavero /
 2 x 0.7 cm Placa
 Técnica de Impresión: Láser / Pantógrafo
 Colores: Negro

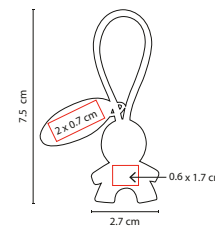

Incluye placa metálica para grabado y caja individual.



■ M 2080

LLAVERO AUTO CON PLACA

Material: Hule / Metal
 Medida: 4 x 7 cm Llavero /
 3 x 1.4 cm Placa
 Área de Impresión: 1.4 x 0.5 cm Llavero /
 2 x 0.7 cm Placa
 Técnica de Impresión: Láser / Pantógrafo
 Colores: Negro

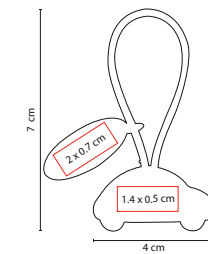

Incluye placa metálica para grabado y caja individual.





■ M 2075

LLAVERO WETAR

Material: Metal / Curpiel
 Medida: 4.2 x 9.6 cm
 Área de Impresión: 3 x 2.5 cm
 Técnica de Impresión: Láser
 Colores: Negro

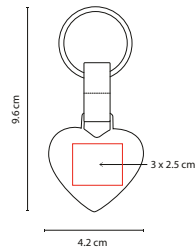

Incluye caja individual.



■ M 2040

LLAVERO LOVE

Material: Hule / Metal
 Medida: 2.2 x 10 cm
 Área de Impresión: 1.5 x 0.8 cm
 Técnica de Impresión: Láser
 Colores: Rojo
 Colores GTM: Rojo

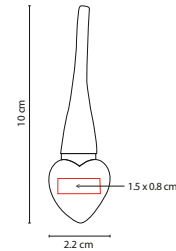

Incluye caja individual.



■ M 2025

LLAVERO AUTO

Material: Curpiel / Metal
 Medida: 2 x 9 cm
 Área de Impresión: 1 x 3 cm
 Técnica de Impresión: Láser
 Colores: Negro

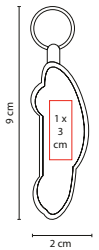

Incluye caja individual.



■ M 63280

LLAVERO **LABORO**

Material: Metal
Medida: 2.7 x 7.1 cm
Área de Impresión: 2.1 x 2.6 cm
Técnica de Impresión: Goteado en Resina /
Grabado Espejo / Serigrafía
Colores: Plata
■ ■ Colores GTM: Plata

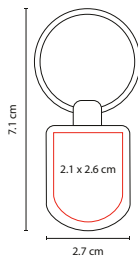

Incluye caja individual.



■ M 63282

LLAVERO **SQUARE**

Material: Metal
Medida: 2.6 x 7.2 cm
Área de Impresión: 2 x 2.9 cm
Técnica de Impresión: Goteado en Resina /
Grabado Espejo / Serigrafía
Colores: Plata
■ ■ Colores GTM: Plata

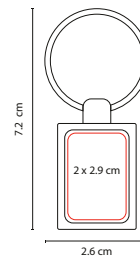

Incluye caja individual.



■ M 6232

LLAVERO **ASTORIA**

Material: Metal
Medida: 2.7 x 6.9 cm
Área de Impresión: 1.9 x 2.9 cm
Técnica de Impresión: Goteado en Resina /
Grabado Espejo
Colores: Plata

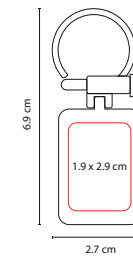

Incluye estuche especial.





■ M 3401

LLAVERO VOSTOK

Material: Metal
 Medida: 2.9 x 5.5 cm
 Área de Impresión: 2.2 x 1.9 cm
 Técnica de Impresión: Goteado en Resina
 Colores: Plata

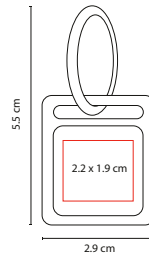

■ M 63283

LLAVERO RUBENS

Material: Metal
 Medida: 3.4 x 7.3 cm
 Área de Impresión: 2.9 cm Diámetro
 Técnica de Impresión: Goteado en Resina /
 Grabado Espejo / Serigrafía
 Colores: Plata
 Colores GTM: Plata

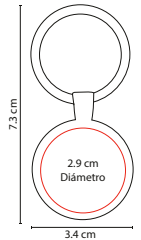

Incluye caja individual.



■ K 63290

LLAVERO CASA-COCHE

Material: Metal
 Medida: 1.9 x 10 cm
 Área de Impresión: 1.3 x 2.7 cm
 Técnica de Impresión: Pantógrafo
 Colores: Plata
 ■ Colores GTM: Plata

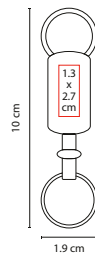

Incluye 2 arillos separables y caja individual.



■ M 63288

LLAVERO BIBURY

Material: Metal
 Medida: 3.2 cm Diámetro
 Área de Impresión: 2.3 cm Diámetro
 Técnica de Impresión: Láser
 Colores: Plata

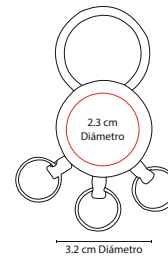

Llavero metálico con tres argollas. Incluye caja individual.



■ M 64104-12

LLAVERO ARGOLLA TRIPLE

Material: Metal
 Medida: 2.2 x 7.8 cm
 Área de Impresión: 1.7 x 2 cm
 Técnica de Impresión: Pantógrafo
 Colores: Plata
 ■ Colores GTM: Plata

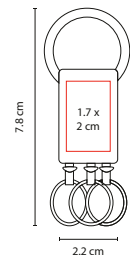

Incluye 3 arillos y caja individual.





■ M 63284

LLAVERO DREVO

Material: Madera
 Medida: 2.9 x 9 cm
 Área de Impresión: 1.7 x 3 cm
 Técnica de Impresión: Láser / Serigrafía
 Colores: Beige
 Colores GTM: Beige

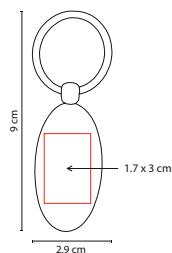

Incluye caja individual.



■ M 63285

LLAVERO LÍBANO

Material: Madera / Metal
 Medida: 3.2 x 8 cm
 Área de Impresión: 1.8 x 2.5 cm
 Técnica de Impresión: Láser / Serigrafía
 Colores: Beige

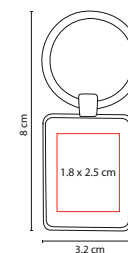

Incluye caja individual.



■ 60700

SET DE ESCRITORIO **VINTRA**

Material: Curpiel / Metal
 Técnica de Impresión: Láser /
 Serigrafía
 Colores: Negro

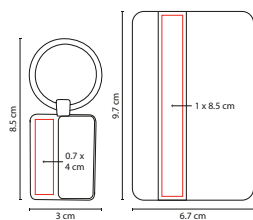

Incluye tarjetero, llavero y caja de regalo.



■ 60100

SET **DUKE**

Material: Curpiel / Metal
 Técnica de Impresión: Láser /
 Serigrafía / Termograbado
 Tinta: Negra
 Colores: Café

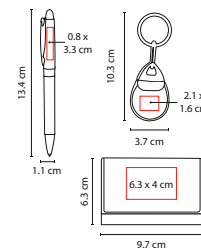

Incluye llavero, tarjetero, bolígrafo y estuche.





■ 61200

SET PRINCE

Material: Curpiel / Metal
 Técnica de Impresión: Láser /
 Serigrafía / Termograbado

Tinta: Negra

Colores: Negro

■ Colores GTM: Negro

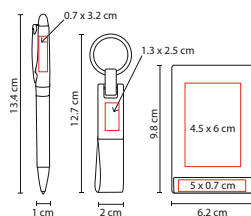

Incluye llavero, tarjetero, bolígrafo y estuche.



■ 61500

SET PLITVICE

Material: Curpiel / Metal
 Técnica de Impresión: Grabado Espejo /
 Láser / Serigrafía

Tinta: Negra

Colores: Negro

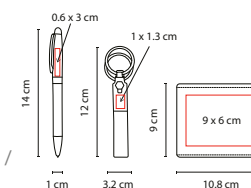

Incluye bolígrafo, llavero y cartera con organizador de tarjetas y credenciales.
 Compartimento doble para billetes.



■ 60200

SET DE ESCRITORIO LENAR

Material: Metal
 Técnica de Impresión: Láser / Serigrafía
 Tinta: Azul
 Colores: Plata
 Colores GTM: Plata

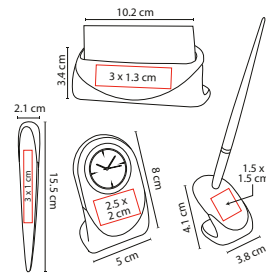

Incluye tarjetero, base con bolígrafo, abrecartas, reloj y caja de regalo.



■ 61900

SET BORAWLI

Material: Curpiel / Metal
 Técnica de Impresión: Láser / Serigrafía
 Tinta: Negra
 Colores: Negro

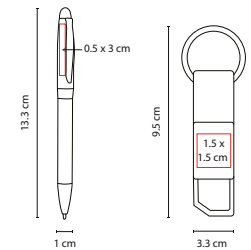

Incluye bolígrafo, llavero y caja de regalo.



■ 60800

SET DE ESCRITORIO **MONARCA**

Material: Hule / Metal
 Técnica de Impresión: Láser / Serigrafía
 Colores: Negro con Plata

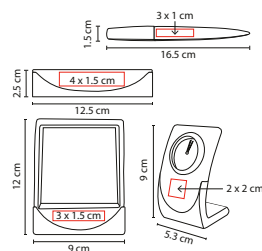

Incluye reloj, porta notas (100 hojas), abrecartas, tarjetero y caja de regalo.



■ KTC 045

ORGANIZADOR **RODANO**

Material: Curpiel
 Medida: 8.9 x 9.9 cm
 Área de Impresión: 4 x 4 cm
 Técnica de Impresión: Tampografía
 Colores: Negro

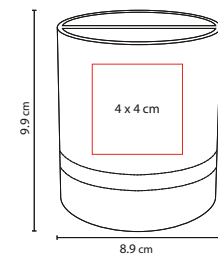

Porta plumas con doble portarretrato. Tamaño de la foto 5 x 7 cm.



■ PRO 519

MINI KIT DE ESCRITORIO

Material: Metal / Plástico

Medida: 9.2 x 6 cm

Área de Impresión: 6.2 x 4.5 cm

Técnica de Impresión: Serigrafía

Colores: Transparente

■ ■ Colores GTM: Transparente



Contiene: Engrapadora, perforadora, despachador de cinta y quita grapas.



■ PRO 055

PORTA CLIPS IMANTADO ANTI-STRESS

Material: Plástico

Medida: 8.7 x 2.3 cm

Área de Impresión: 5 x 1.2 cm

Técnica de Impresión: Serigrafía

Colores: Blanco

■ ■ Colores GTM: Blanco

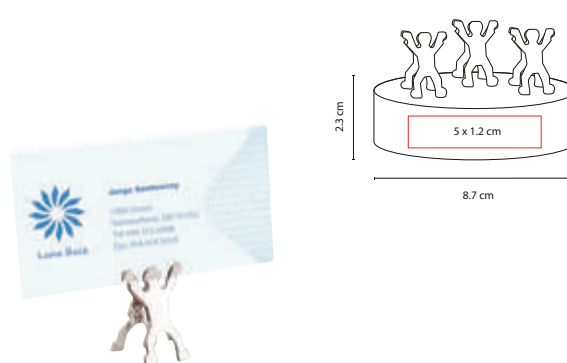

Incluye 8 clips.



■ KTC 210

ORGANIZADOR LAHN

Material: Plástico

Medida: 7 x 10.5 cm

Área de Impresión: 4 x 3.5 cm Porta Plumas /
2.5 x 1 cm Base

Técnica de Impresión: Serigrafía

Colores: Blanco con Gris

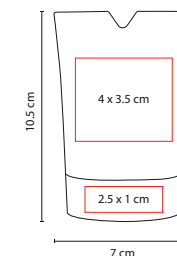

Base desprendible con compartimento para clips y soporte para smartphone.



■ **61300**

MULTI ORGANIZADOR **SANTAREN**

Material: Plástico
 Técnica de Impresión: Serigrafía
 Colores: Blanco con Gris

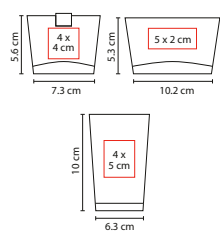

Incluye despachador de clips, porta plumas, despachador doble para pines y caja de regalo.



■ **61400**

MULTI ORGANIZADOR **REIDEN**

Material: Plástico
 Medida: 13.2 x 8.9 cm
 Área de Impresión: 4 x 4 cm
 Técnica de Impresión: Serigrafía
 Colores: Blanco con Gris

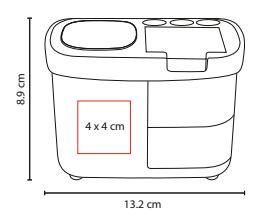

Despachador imantado de clips, porta plumas, porta notas y 2 compartimentos.



■ KTC 520

SET IZABAL

Material: Madera
 Medida: 6.1 x 6.1 cm
 Área de Impresión: 5 x 1.5 cm
 Técnica de Impresión: Láser / Serigrafía

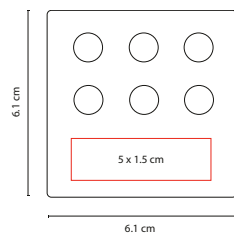

No incluye accesorios.



■ KTC 310

BASE CHOOYU

Material: Madera
 Medida: 6.5 x 10.5 cm Base /
 5 x 9.5 cm Figura
 Área de Impresión: 0.7 x 5 cm Base /
 1 x 2.5 cm Figura
 Técnica de Impresión: Láser / Serigrafía

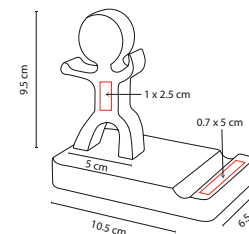



■ KTC 510

MULTI ORGANIZADOR **ARGEL**

Material: Curpiel
 Medida: 20 x 9.5 cm
 Área de Impresión: 14 x 4 cm
 Técnica de Impresión: Láser / Serigrafía
 Colores: Negro

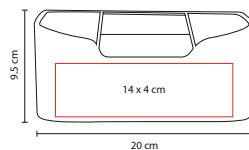

Incluye 5 compartimentos en diferentes tamaños.



■ KTC 500

MULTI ORGANIZADOR **HANSEL**

Material: Curpiel
 Medida: 18 x 10.7 cm
 Área de Impresión: 8 x 8 cm
 Técnica de Impresión: Láser / Serigrafía
 Colores: Café

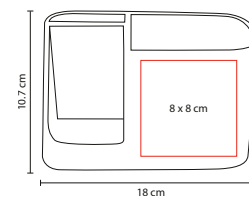

Incluye 3 compartimentos en diferentes tamaños.



■ M 8500

TARJETERO GLASBA

Material: Plástico
 Medida: 10.3 x 6 cm
 Área de Impresión: 6 x 4 cm
 Técnica de Impresión: Serigrafía
 Colores: Blanco
 ■ Colores GTM: Blanco

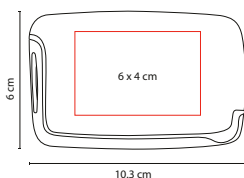

Tarjetero con sistema giratorio.



■ M 83500

TARJETERO SAVE

Material: Plástico / Aluminio
 Medida: 10.5 x 7 cm
 Área de Impresión: 7 x 4 cm
 Técnica de Impresión: Láser / Serigrafía
 Colores: Plata
 ■ Colores GTM: Plata

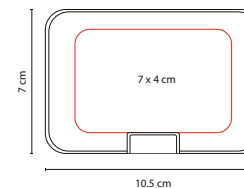

Con 6 espacios para tarjetas.



■ M 83964

TARJETERO VEKONY

Material: Aluminio

Medida: 9.3 x 5.9 cm

Área de Impresión: 7 x 3 cm

Técnica de Impresión: Láser / Pantógrafo / Serigrafía

Colores: Plata

Colores GTM: Plata

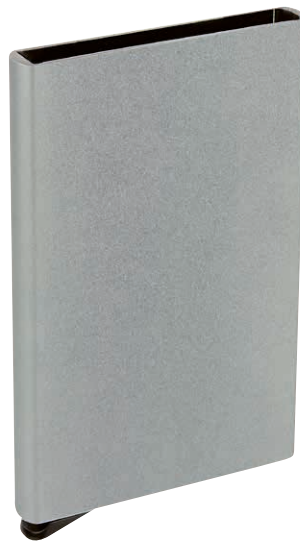
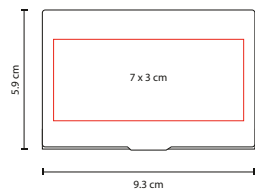

■ M 83230

TARJETERO KALI

Material: Aluminio

Medida: 6.3 x 10 cm

Área de Impresión: 5 x 8 cm

Técnica de Impresión: Láser / Pantógrafo / Serigrafía

Colores: Gris

Colores GTM: Gris

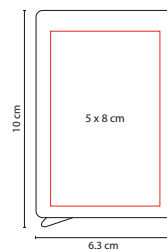

Tarjetero vertical. Mecanismo "Pop up" para desplegar tarjetas.
Sistema anti robo RFID.



■ M 86114-5

TARJETERO PRAZA

Material: Aluminio

Medida: 9.3 x 6 cm

Área de Impresión: 7 x 2.5 cm

Técnica de Impresión: Láser / Pantógrafo / Serigrafía

Colores: Plata

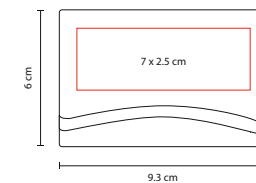



■ M 83400

TARJETERO KOZE

Material: Curpiel / Metal
 Medida: 6.4 x 9.5 cm
 Área de Impresión: 5 x 5 cm Curpiel /
 5 x 0.8 cm Metal
 Técnica de Impresión: Láser /
 Serigrafía / Termograbado
 Colores: Negro

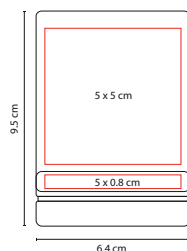

Tarjetero vertical. Doble compartimento.



■ M 83750

TARJETERO NOSHAQ

Material: Aluminio / Plástico
 Medida: 10.5 x 7 cm
 Área de Impresión: 7 x 4 cm
 Técnica de Impresión: Láser / Serigrafía
 Colores: Plata

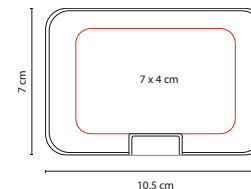

Cuenta con 5 espacios para tarjetas y batería auxiliar capacidad 2500 mAh. Incluye cable adaptador compatible con micro USB. Sistema anti robo RFID.





■ M 8600

TARJETERO GANGKHAR

Material: Aluminio
 Medida: 3.5 x 8.2 cm Llavero /
 6 x 9.5 cm Tarjetero
 Área de Impresión: 1 x 2.5 cm Llavero /
 4 x 7 cm Tarjetero
 Técnica de Impresión: Láser / Serigrafía
 Colores: Gris

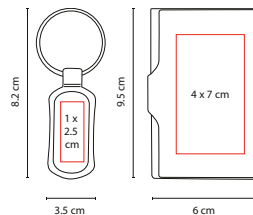

Incluye tarjetero y llavero.



■ M 83450

TARJETERO HAUT

Material: Curpiel / Metal
 Medida: 9.5 x 6.5 cm
 Área de Impresión: 8 x 2.5 cm Curpiel /
 8 x 0.8 cm Metal
 Técnica de Impresión: Láser /
 Serigrafía / Termograbado
 Colores: Café

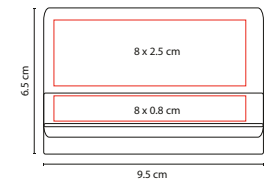

Tarjetero horizontal. Doble compartimento.



V



HL 040

PORTA NOTAS **ERIA**

Material: Cartón
 Medida: 8.4 x 6.5 cm
 Área de Impresión: 7 x 5 cm
 Técnica de Impresión: Serigrafía
 Colores: A/BE/N/O/R/V



N

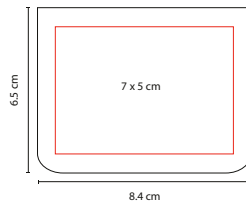

BE



O



A



R

Incluye 160 hojas de notas.

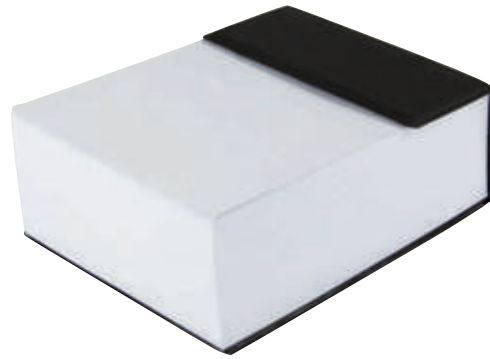

N

HL 6560

BLOCK DE NOTAS **ADDAR**

Material: PVC
 Medida: 8 x 11 cm
 Área de Impresión: 7 x 2.5 cm
 Técnica de Impresión: Serigrafía
 Colores: A/N/R

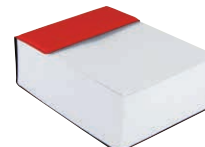
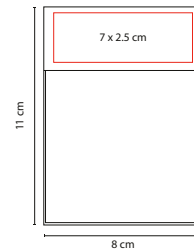

R



A

Incluye 400 hojas de notas.



R

HL 6500

CLIP PORTA NOTAS **CARVI**

Material: Plástico
 Medida: 7.2 cm Diámetro
 Área de Impresión: 3 x 1 cm
 Técnica de Impresión: Serigrafía
 Colores: A/B/R
 Colores GTM: A/B/R

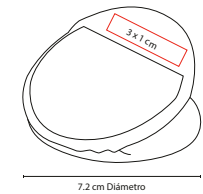

B



A

Clip porta notas con imán. 30 Notas adheribles.





B

HL 6035

PORTA NOTAS VENTALL

Material: Plástico
 Medida: 5.2 x 8.4 cm
 Área de Impresión: 3.5 x 7 cm
 Técnica de Impresión: Serigrafía
 Tinta: Negra
 Colores: A/B/R
 Colores GTM: A/B/R

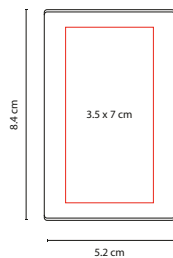

R



A

Incluye mini bolígrafo,
 20 notas adheribles amarillas y bandera de 3 colores.



R

HL 6570

PORTA NOTAS ANDES

Material: Cartón
 Medida: 10.2 x 8 cm
 Área de Impresión: 9 x 6 cm
 Técnica de Impresión: Serigrafía
 Colores: A/N/R

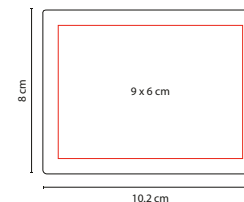

N



A



Incluye diferentes notas adheribles: 100 en forma de nube de texto,
 25 amarillas y banderas de colores.



HL 6530

PORTA NOTAS AZALAI

Material: Cartón / Papel
 Medida: 10.3 x 15.4 cm
 Área de Impresión: 8 x 3 cm
 Técnica de Impresión: Serigrafía
 Tinta: Negra
 Colores: Beige
 Colores GTM: Beige

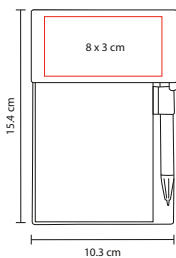

Incluye bolígrafo ecológico y notas adheribles:
 100 en color beige y banderas de colores.



HL 6015

SEPARADOR ECOLÓGICO KIKORI

Material: Cartón / Papel
 Medida: 5.7 x 22 cm
 Área de Impresión: 5 x 4.5 cm
 Técnica de Impresión: Serigrafía
 Colores: Beige
 Colores GTM: Beige

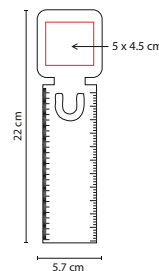

Incluye notas adheribles: 25 amarillas y banderas de colores.
 Regla de 14 cm impresa.



HL 6270

PORTA NOTAS DOKKA

Material: Cartón / Papel / Plástico
 Medida: 16.5 x 10.2 cm
 Área de Impresión: 14 x 8 cm
 Técnica de Impresión: Serigrafía
 Tinta: Negra
 Colores: Beige

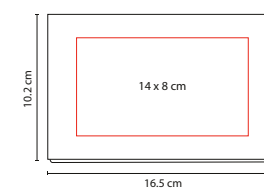

Incluye bolígrafo ecológico, porta plumas, regla de 15 cm,
 clips y notas adheribles: 100 en color beige y banderas de colores.





HL 6245

PORTA NOTAS **HAYMAN**

Material: Cartón / Papel
 Medida: 14 x 10 cm
 Área de Impresión: 11 x 6 cm
 Técnica de Impresión: Serigrafía
 Tinta: Negra
 Colores: Beige
 Colores GTM: Beige

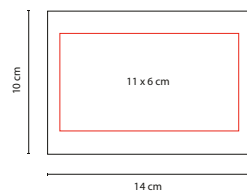

Incluye bolígrafo ecológico, regla de 12 cm, 100 hojas de notas blancas, 25 notas adheribles beige y banderas de 5 colores.

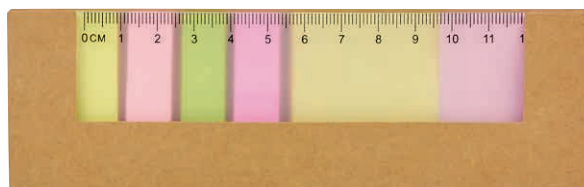

HL 6030

PORTA NOTAS **LULE**

Material: Cartón / Papel / Plástico
 Medida: 16 x 5 cm
 Área de Impresión: 14 x 1.5 cm
 Técnica de Impresión: Serigrafía
 Colores: Beige

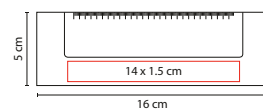

Incluye notas adheribles: 25 amarillas, 25 rosas y banderas de colores. Regla de 12 cm en la cubierta.



HL 61200

PORTA NOTAS **INZIA**

Material: Cartón / Papel
 Medida: 15.4 x 6 cm
 Área de Impresión: 12 x 4 cm
 Técnica de Impresión: Serigrafía
 Tinta: Negra
 Colores: Beige
 Colores GTM: Beige

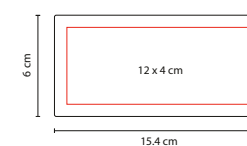

Incluye notas adheribles de diferentes colores, regla de 12 cm y bolígrafo ecológico.



■ HL 6230

PORTA NOTAS **ANSER**

Material: Cartón / Papel
 Medida: 8.6 x 8.6 cm
 Área de Impresión: 6 x 6 cm
 Técnica de Impresión: Serigrafía
 Colores: Beige
 ■ ■ Colores GTM: Beige

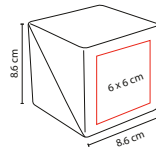

Incluye porta plumas y diferentes notas adhesibles: 500 de diferente color, 25 amarillas y banderas de colores.



■ HL 6140

PORTA NOTAS **CHAJARI**

Material: Cartón / Papel
 Medida: 10.5 x 10.9 cm
 Área de Impresión: 4 x 5 cm
 Técnica de Impresión: Serigrafía
 Colores: Beige

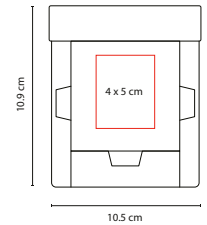

Incluye porta plumas, clips, 150 notas adhesibles amarillas, 50 hojas de notas blancas, 100 hojas de notas multicolor y banderas de 5 colores.





■ HL 6655

ESTUCHE CON PORTA NOTAS - CALENDARIO

Material: Plástico
 Medida: 14.8 x 8.7 cm
 Área de Impresión: 11 x 6 cm
 Técnica de Impresión: Serigrafía
 Colores: Negro
 ■ Colores GTM: Negro

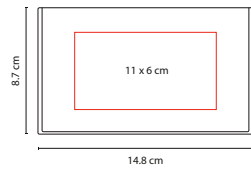

Incluye notas adhesibles y calendario con dos años.



■ HL 6520

PORTA NOTAS BOX NOTES

Material: Plástico
 Medida: 9 x 9.4 cm
 Área de Impresión: 5 x 5 cm
 Técnica de Impresión: Serigrafía
 Colores: Negro
 ■ Colores GTM: Negro

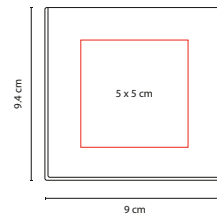

Incluye 200 hojas de notas y calendario con dos años.



■ CT 090

PORTA NOTAS CON CALCULADORA

Material: Plástico
 Medida: 13 x 10.5 cm
 Área de Impresión: 3 x 3 cm
 Técnica de Impresión: Serigrafía
 Colores: Negro

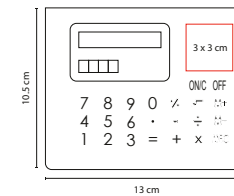

Calculadora solar de 8 dígitos. Incluye notas adhesibles, banderas de colores y calendario con dos años.



ECOLÓGICA

**LIBRETA ANTLIA
HL 2040**

Libreta con 70 Hojas de raya.
Incluye bolígrafo ecológico y espiral metálico doble.



CT 150

CALCULADORA COLGABLE **ENCORE**

Material: Plástico

Medida: 6.4 x 9.7 cm

Área de Impresión: 4 x 0.5 cm

Técnica de Impresión: Tampografía

Colores: A/N/R

Colores GTM: A/N/R

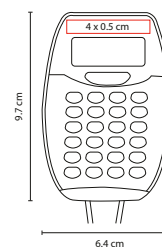

N



R



A

Calculadora de 8 dígitos. Incluye cordón de 48 cm. Batería solar.



N

■ CT 700

CALCULADORA MAX

Material: Plástico
 Medida: 13 x 13 cm
 Área de Impresión: 4 x 2.5 cm
 Técnica de Impresión: Serigrafía
 Colores: A/N/R

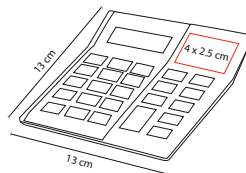

R



A

Calculadora bitono de 8 dígitos. Incluye 1 batería de botón.



■ CT 1630

CALCULADORA WALLET

Material: Plástico
 Medida: 10 x 7 cm
 Área de Impresión: 5 x 1 cm
 Técnica de Impresión: Serigrafía
 Colores: Plata con Negro

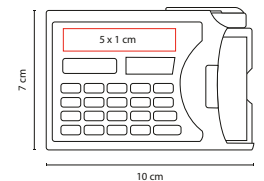

Calculadora de 8 dígitos. Incluye tarjetero y bolígrafo. Batería solar.



PRO 026

PORTAGAFETE BRESLE

Material: Plástico
 Medida: 3.5 x 8.7 cm
 Área de Impresión: 2.2 cm Diámetro
 Técnica de Impresión: Goteado en Resina
 Colores: Blanco

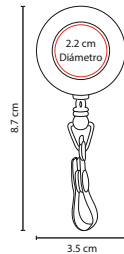

Cinta flexible de plástico de 1 m. Incluye clip porta tarjetas.



A

PRO 027

PORTAGAFETE RETRÁCTIL

Material: Plástico
 Medida: 3.2 x 8.2 cm
 Área de Impresión: 2.1 cm Diámetro
 Técnica de Impresión: Goteado en Resina
 Colores: A/B/N/O/R/V
 Colores GTM: A/B/N/R/V

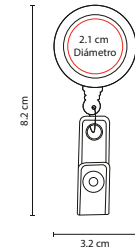

Cordón de 85 cm. Incluye clip porta tarjetas.





PRO 030

PORTAGAFETE GAURI

Material: Metal
 Medida: 3.2 x 8 cm
 Área de Impresión: 2.2 cm Diámetro
 Técnica de Impresión: Goteado en Resina
 Colores: Plata

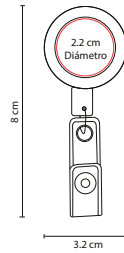

Cordón de 70 cm. Incluye clip porta tarjetas.



PRO 065

PORTAGAFETE IDENTITY

Material: Plástico
 Medida: 3.3 x 50 cm
 Área de Impresión: 2.6 cm Diámetro
 Técnica de Impresión: Goteado en Resina
 Colores: A/B/R

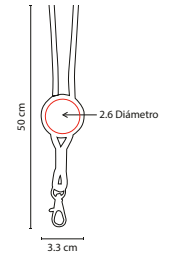

Incluye gancho metálico.



■ CAL 2019

CALENDARIO ORGANIZADOR

Material: Cartoncillo / Papel Bond
 Medida: 27.9 x 43.2 cm
 Área de Impresión: 27.7 x 10.4 cm
 Técnica de Impresión: Serigrafía
 Colores: Gris con Blanco

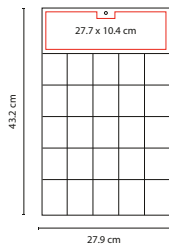

Calendario vertical 2019. Incluye días festivos, recordatorio de pagos y notas.



■ CAL 010

CALENDARIO MOVE IT

Material: Plástico
 Medida: 12 x 18.4 cm
 Área de Impresión: 9.5 x 2 cm
 Técnica de Impresión: Serigrafía
 Colores: Negro

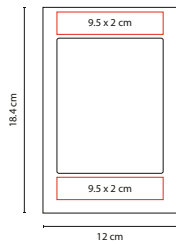

Calendario con dos años.



■ CAL 100

CALENDARIO ONTUR

Material: Metal
 Medida: 10 x 10 cm Abierto
 Área de Impresión: 8 x 3.5 cm
 Técnica de Impresión: Láser / Serigrafía
 Colores: Plata

Colores GTM: Plata

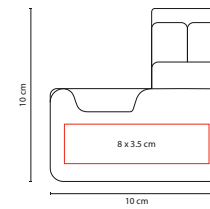

Calendario universal.



■ CAL 005

CALENDARIO MONTECARLO

Material: Aluminio
 Medida: 10.5 x 8.9 cm
 Área de Impresión: 8 x 1.5 cm
 Técnica de Impresión: Láser / Pantógrafo
 Colores: Plata

Colores GTM: Plata

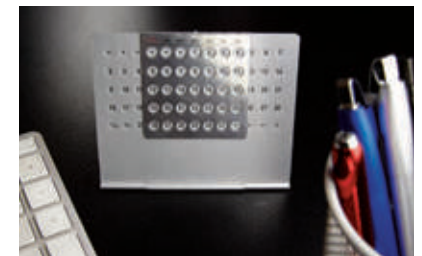
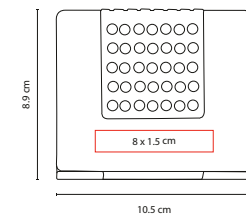

Calendario universal.

LIBRETAS Y CARPETAS



A

ZEGNO®

HL 2020

LIBRETA LOVECOLORS

Material: Curpiel

Medida: 9.8 x 14.6 cm

Área de Impresión: 7 x 11 cm

Técnica de Impresión: Serigrafía / Termograbado

Colores: A/N/O/P/R/V/Y

Colores GTM: A/N/R

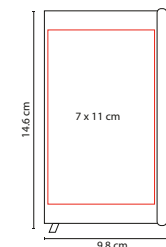

OFICINA



LIBRETAS DE BOLSILLO



192

80 Hojas de raya. Incluye separador de hojas y elástico para cerrar.



R

HL 190

LIBRETA TOBA

Material: Cartón
 Medida: 12 x 14.5 cm
 Área de Impresión: 8 x 4.5 cm
 Técnica de Impresión: Serigrafía
 Tinta: Negra
 Colores: A/O/R/V
 Colores GTM: A/R/V

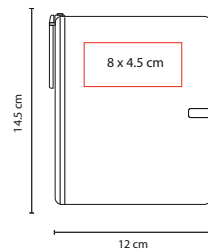

A

HL 1700

LIBRETA TADIA

Material: Cartón
 Medida: 6.5 x 12 cm
 Área de Impresión: 5 x 9 cm
 Técnica de Impresión: Serigrafía
 Colores: A/O/R/V/Y

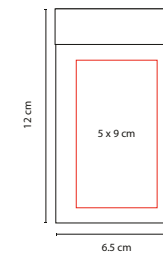

O

V

A



O

Y

R

V

100 Hojas de raya. Incluye sobre en el interior. Cierra con elástico. Incluye bolígrafo.

30 Hojas de raya desprendibles.



V

■ HL 090

LIBRETA KADY

Material: Plástico
 Medida: 9 x 13.8 cm Libreta /
 1 x 4 cm Bolígrafo
 Área de Impresión: 5 x 11 cm
 Técnica de Impresión: Serigrafía
 Tinta: Negra
 Colores: A/O/P/R/V

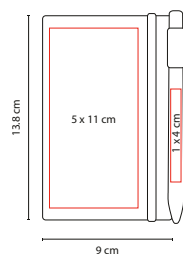

A

■ HL 2720

BLOCK DE NOTAS CON BOLÍGRAFO

Material: Plástico
 Medida: 7.9 x 10.5 cm
 Área de Impresión: 5 x 8 cm
 Técnica de Impresión: Serigrafía
 Tinta: Negra
 Colores: A/B/O/P/R/V
 ■ ■ Colores GTM: A/B/R

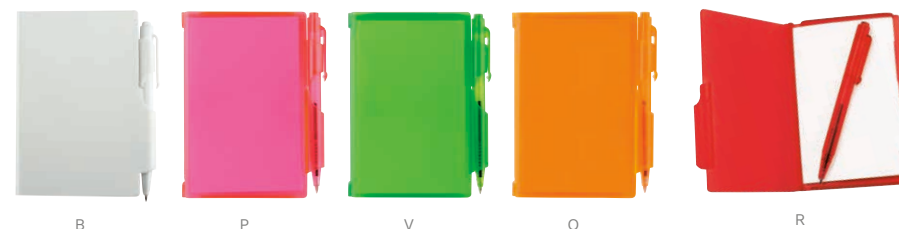
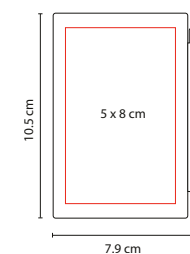

B

P

V

O

R

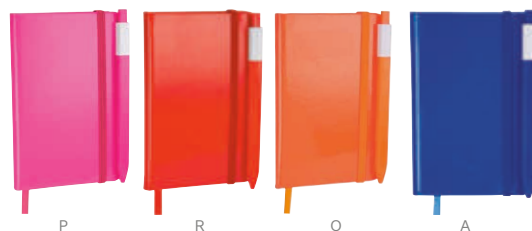

P

R

O

A





V

HL 1300

LIBRETA WENDEL

Material: Cartón / Espiral Plástico
 Medida: 9 x 14 cm
 Área de Impresión: 6 x 12 cm
 Técnica de Impresión: Serigrafía
 Colores: A/N/O/R/V

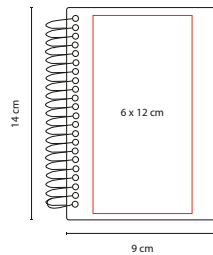

R

A

N

O

90 Hojas de raya.



O

HL 6000

LIBRETA FUN-WORK

Material: Espiral Metálico / Plástico
 Medida: 10 x 12 cm
 Área de Impresión: 5 x 10 cm
 Técnica de Impresión: Serigrafía
 Tinta: Negra
 Colores: A/N/O/R/V
 Colores GTM: A/N/R/V



COMPARATIVO DE TAMAÑO
 HL 5000 Y HL 6000

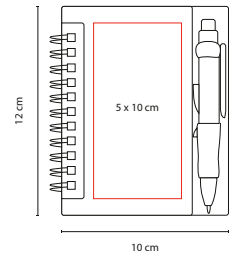

A

N

V

R

60 Hojas de raya. Incluye bolígrafo.



HL 1500

LIBRETA SCRIF

Material: Curpiel
 Medida: 8.5 x 13 cm
 Área de Impresión: 3 x 3.5 cm Cubierta /
 2.5 x 1 cm Placa Metálica
 Técnica de Impresión: Láser / Serigrafía
 Colores: A/C/N/O/P/R/V
 Colores GTM: C/N

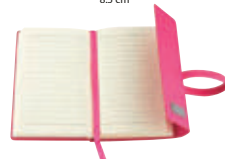
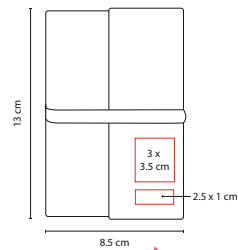

120 Hojas de raya.
 Incluye separador de hojas y placa para grabado.



HL 1650

LIBRETA VALANTI

Material: Curpiel
 Medida: 8.8 x 15.5 cm
 Área de Impresión: 6 x 6 cm
 Técnica de Impresión: Serigrafía / Termograbado
 Colores: A/C/N/R

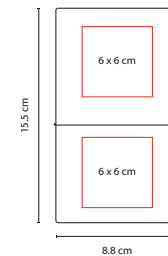

70 Hojas de raya. Incluye separador de hojas.



HL 7400

LIBRETA DE BOLSILLO CON CALCULADORA

Material: Curpiel
 Medida: 9 x 14.7 cm
 Área de Impresión: 6.5 x 6 cm
 Técnica de Impresión: Láser / Serigrafía
 Colores: A/N/R

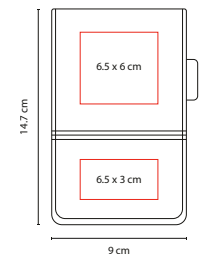

Incluye calculadora solar de 8 dígitos, elástico para bolígrafo
 y 30 Hojas de notas. Bolígrafo no incluido.





HL 130

LIBRETA MARNE

Material: Cartón / Espiral Metálico

Medida: 9.8 x 9.8 cm

Área de Impresión: 6 x 6 cm

Técnica de Impresión: Serigrafía

Colores: Beige

Colores GTM: Beige

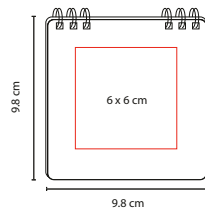

40 Hojas de raya. Contiene 5 tiras de notas adheribles.
Espiral metálico doble.



HL 2030

LIBRETA MALIA

Material: Cartón / Espiral Metálico

Medida: 9.5 x 17 cm

Área de Impresión: 7 x 11 cm Cubierta /
7 x 2.5 cm Interior

Técnica de Impresión: Serigrafía

Tinta: Negra

Colores: Beige

Colores GTM: Beige

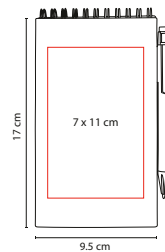

20 Hojas de raya. Incluye notas adheribles,
bolígrafo ecológico y espiral metálico doble.



R



HL 2010

LIBRETA ECOLÓGICA GREEN PLANET

Material: Cartón / Espiral Metálico / Papel Reciclado

Medida: 7.7 x 12.7 cm

Área de Impresión: 6 x 5 cm

Técnica de Impresión: Serigrafía

Tinta: Negra

Colores: A/N/O/R/V

Colores GTM: A/N/R/V

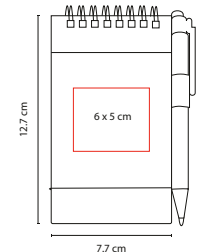

A



V



O



N



50 Hojas de raya. Incluye bolígrafo ecológico de cartón reciclado.



HL 016

LIBRETA JOG

Material: Cartón
Medida: 10.2 x 15.7 cm
Área de Impresión: 5 x 10 cm
Técnica de Impresión: Serigrafía
Tinta: Negra
Colores: Café

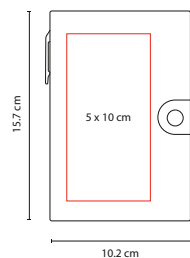

50 Hojas blancas. Incluye broche para cerrar, notas adheribles de diferentes colores y bolígrafo ecológico.



HL 018

LIBRETA PALOUSE

Material: Cartón
Medida: 10.7 x 15.6 cm
Área de Impresión: 8 x 12 cm
Técnica de Impresión: Serigrafía
Tinta: Negra
Colores: Beige

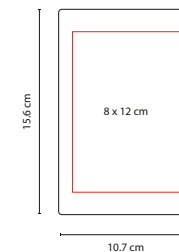

70 Hojas de raya. Incluye notas adheribles de diferentes colores, regla de 12 cm, compartimento para tarjetas y bolígrafo ecológico.





HL 017

LIBRETA OWAMI

Material: Curpiel
 Medida: 12 x 16 cm
 Área de Impresión: 6 x 12 cm
 Técnica de Impresión: Termograbado
 Tinta: Negra
 Colores: Negro

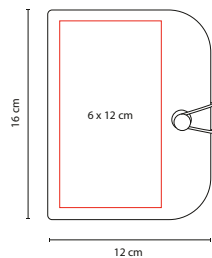

70 Hojas de raya. Incluye elástico para cerrar, notas adhesivas de diferentes colores y bolígrafo ecológico.



V



HL 2050

LIBRETA RIDGE

Material: Cartón
 Medida: 14.3 x 18 cm
 Área de Impresión: 6 x 13 cm
 Técnica de Impresión: Serigrafía
 Tinta: Azul
 Colores: A/N/O/R/V
 Colores GTM: A/O/R/V

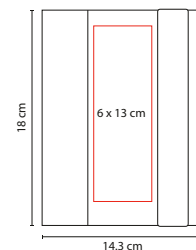

O N A R

70 Hojas de raya. Incluye notas adhesivas en diferentes colores, bolígrafo ecológico y elástico para cerrar.



HL 1550

LIBRETA ECOLIER

Material: Cartón
 Medida: 8.7 x 14 cm
 Área de Impresión: 4 x 12 cm
 Técnica de Impresión: Serigrafía
 Colores: AE/O/RE/V

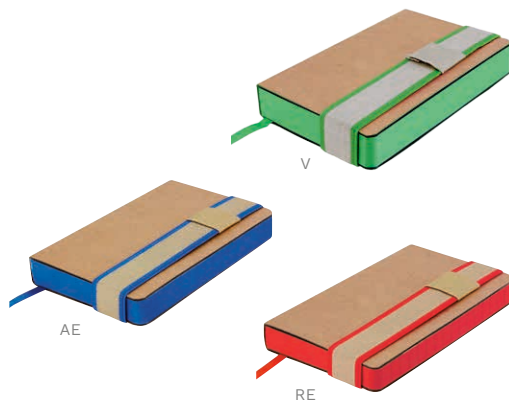
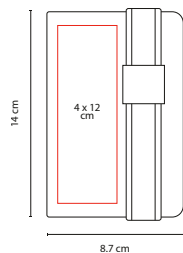

240 Hojas de raya.
 Incluye separador de hojas y elástico para cerrar.

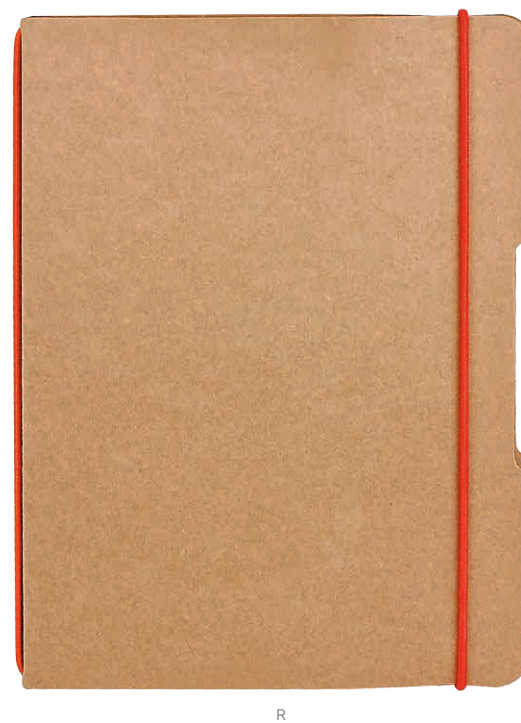

HL 015

LIBRETA BARRON

Material: Cartón
 Medida: 15.2 x 21 cm
 Área de Impresión: 9 x 18 cm
 Técnica de Impresión: Serigrafía
 Colores: A/N/O/R/V
 Colores GTM: A/N/R

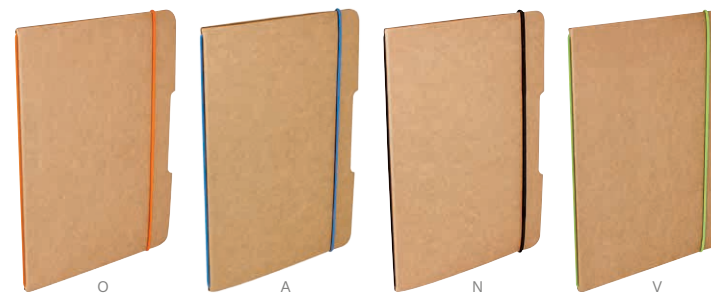
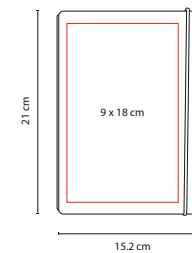

40 Hojas de raya. Incluye elástico para cerrar.





HL 080

LIBRETA DUNYA

Material: Corcho
 Medida: 10 x 14 cm
 Área de Impresión: 6 x 11 cm
 Técnica de Impresión: Láser / Serigrafía
 Colores: Beige

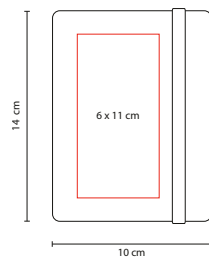

80 Hojas de raya. Incluye separador de hojas y elástico.



HL 4000

LIBRETA VÉRTIGO

Material: Cartón
 Medida: 15.1 x 19.7 cm
 Área de Impresión: 6 x 16 cm
 Técnica de Impresión: Serigrafía
 Tinta: Negra
 Colores: Beige
 Colores GTM: Beige

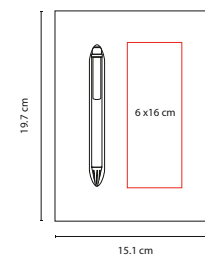

140 Hojas de raya. Incluye bolígrafo.



HL 110

LIBRETA ELSETER

Material: Cartón
 Medida: 9 x 14 cm
 Área de Impresión: 5 x 6 cm
 Técnica de Impresión: Serigrafía
 Colores: Beige

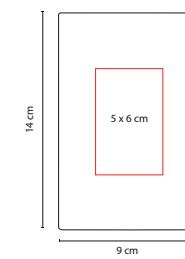

Libreta doble. 80 Hojas de raya (40 hojas de cada lado).



■ HL 120

LIBRETA SAVOIA

Material: Cartón / Espiral Metálico

Medida: 19.8 x 20.5 cm

Área de Impresión: 9 x 11 cm

Técnica de Impresión: Serigrafía

Tinta: Negra

Colores: Beige

■ ■ Colores GTM: Beige

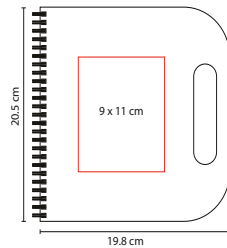

70 Hojas de raya. Incluye notas adheribles, bolígrafo ecológico, compartimento para tarjetas y espiral metálico doble.



A

■ HL 2070

LIBRETA SELIGER

Material: Paja / Curpiel

Medida: 14.7 x 21.3 cm

Área de Impresión: 7 x 7 cm

Técnica de Impresión: Serigrafía / Termograbado

Colores: A/O/R/V

■ ■ Colores GTM: A/R

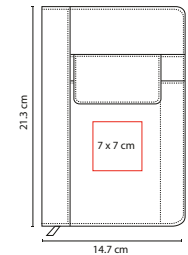

V



O



R

96 Hojas de raya. Incluye separador de hojas, compartimento frontal para smartphone y bolígrafo. No incluye bolígrafo.





N



HL 2012

LIBRETA ECO PAPER

Material: Cartón /
Papel Reciclado

Medida: 7.5 x 10.6 cm

Área de Impresión: 4 x 8 cm

Técnica de Impresión: Serigrafía

Colores: A/N/R

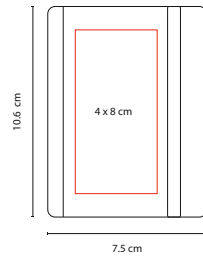

R



A

60 Hojas de raya.



R



HL 2040

LIBRETA ANTLIA

Material: Cartón / Espiral Metálico /
Papel Reciclado

Medida: 15.4 x 20.9 cm

Área de Impresión: 9 x 10 cm

Técnica de Impresión: Serigrafía

Tinta: Negra

Colores: C/N/R/V

Colores GTM: C/R/V

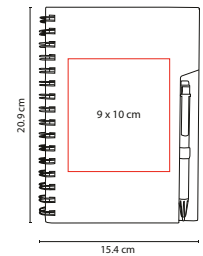

N



C



V

70 Hojas de raya. Incluye bolígrafo ecológico y espiral metálico doble.

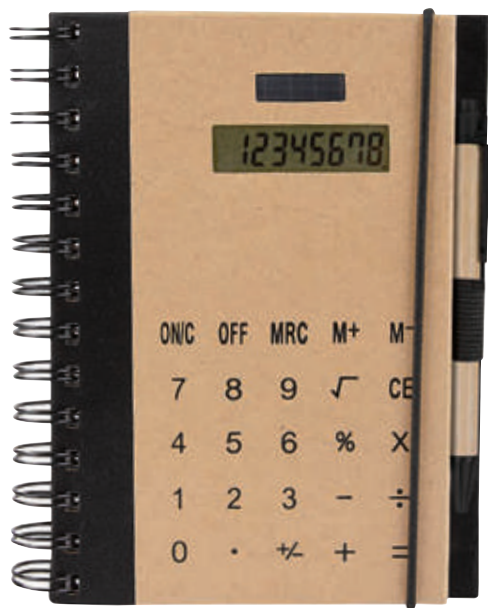

■ CT 400

LIBRETA CALCULADORA ECOWORLD

Material: Cartón / Espiral Metálico / Papel Reciclado

Medida: 12 x 17.8 cm

Área de Impresión: 6.5 x 3 cm

Técnica de Impresión: Serigrafía

Tinta: Negra

Colores: Café con Negro

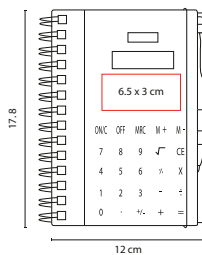

Incluye calculadora solar de 8 dígitos, 100 hojas de raya y bolígrafo.



■ HL 9050

LIBRETA KORYAK

Material: Cartón / Espiral Metálico

Medida: 14 x 18 cm

Área de Impresión: 9 x 14 cm

Técnica de Impresión: Serigrafía

Tinta: Azul

Colores: Beige

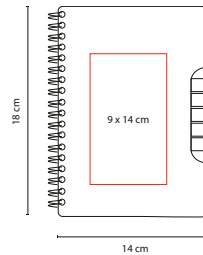

70 Hojas de raya. Incluye notas adhesivas en 5 colores, bolígrafo ecológico y espiral metálica doble.



■ HL 1100

LIBRETA ECOLÓGICA JOLIET

Material: Cartón / Espiral Metálico

Medida: 16.3 x 22 cm

Área de Impresión: 10 x 17 cm

Técnica de Impresión: Serigrafía

Tinta: Negra

Colores: Beige

Colores GTM: Beige



HL 1100
COMPARATIVO DE TAMAÑO

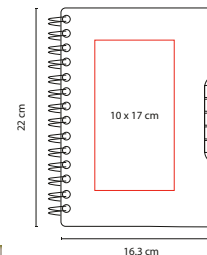

100 Hojas de raya. Incluye notas adhesivas en 5 colores, bolígrafo ecológico y espiral metálica doble.





V



HL 2100

LIBRETA BOK

Material: Curpiel
 Medida: 15 x 21 cm
 Área de Impresión: 6 x 13 cm
 Técnica de Impresión: Láser / Serigrafía / Termograbado
 Colores: A/C/N/O/R/V

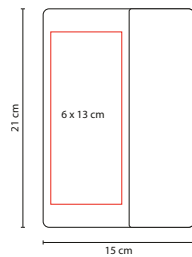

C

O

A

N

R

80 Hojas de raya. Libreta con broche magnético y separador de hojas.



G

ZEGNO®

HL 030

LIBRETA KENYA

Material: Curpiel
 Medida: 14 x 20.7 cm
 Área de Impresión: 10 x 19 cm
 Técnica de Impresión: Serigrafía / Termograbado
 Tinta: Negra
 Colores: A/G/N/R
 Colores GTM: A/G/R

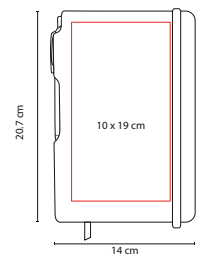

N

A

R

80 Hojas de raya. Incluye separador de hojas y bolígrafo de plástico.



A

Z E G N O®

HL 010

LIBRETA ALESA

Material: Curpiel
Medida: 14.6 x 21.6 cm
Área de Impresión: 8 x 17 cm
Técnica de Impresión: Serigrafía /
Termograbado

Colores: A/M/N/O/P/R/V
Colores GTM: A/R/V

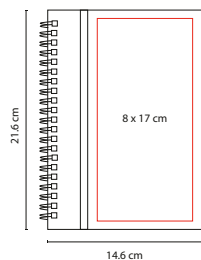

M

V

R

N

P

O

65 Hojas de raya.



R

Z E G N O®

HL 180

LIBRETA DETTIFOSS

Material: Curpiel
Medida: 14.7 x 21.1 cm
Área de Impresión: 8 x 17 cm
Técnica de Impresión: Termograbado / Láser
Colores: A/N/O/R/V

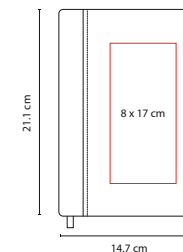

A

O

N

V

80 Hojas de raya. Incluye separador de hojas.



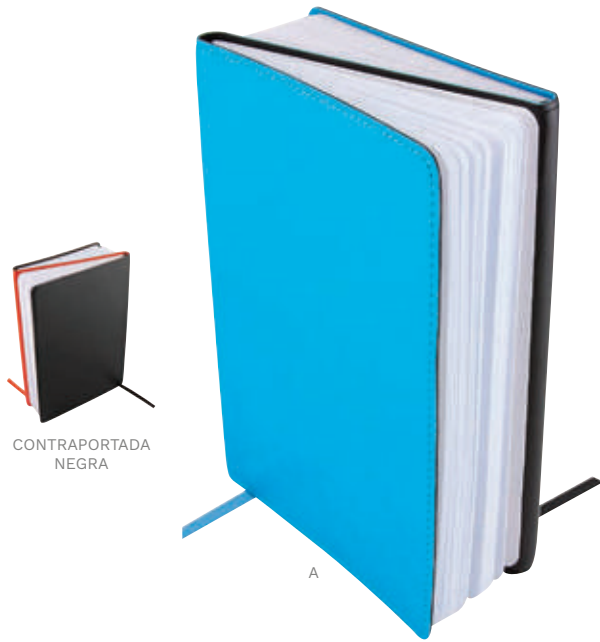

HL 100

LIBRETA ESLS

Material: Curpiel
 Medida: 13 x 18 cm
 Área de Impresión: 7 x 10 cm
 Técnica de Impresión: Serigrafía / Termograbado
 Colores: A/O/R/V

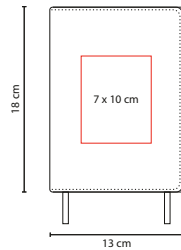

Libreta doble con separadores de hojas.
 160 Hojas de raya (80 hojas de cada lado).



HL 1400

LIBRETA BREKA

Material: Espiral Metálico / Plástico
 Medida: 15.4 x 18 cm
 Área de Impresión: 10 x 15 cm
 Técnica de Impresión: Serigrafía
 Tinta: Negra
 Colores: A/N/R

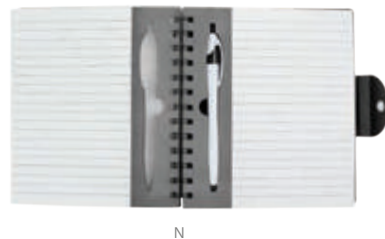
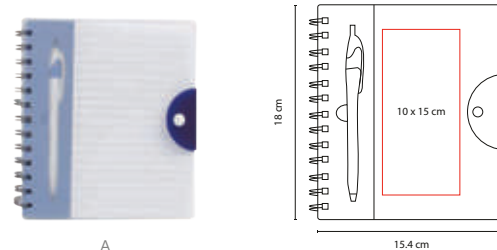

100 Hojas de raya. Incluye bolígrafo y espiral metálico doble.



HL 5000

LIBRETA FRESH

Material: Espiral Metálico / Plástico
 Medida: 13.7 x 16 cm
 Área de Impresión: 7 x 10 cm
 Técnica de Impresión: Serigrafía
 Tinta: Negra
 Colores: A/R/V
 Colores GTM: A/R/V

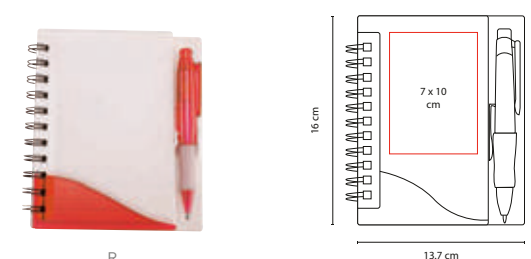

100 Hojas de raya. Incluye bolígrafo.



■ HL 420

LIBRETA **ERBIL**

Material: Cartón
 Medida: 14 x 20.4 cm
 Área de Impresión: 8 x 10 cm
 Técnica de Impresión: Serigrafía
 Colores: A/O/R/V

■ ■ Colores GTM: A/R/V

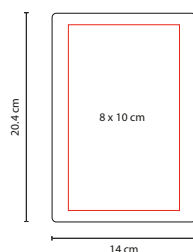
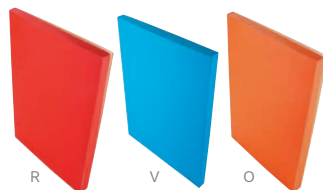

Libreta con canto del mismo color que la cubierta.
 100 Hojas de raya.

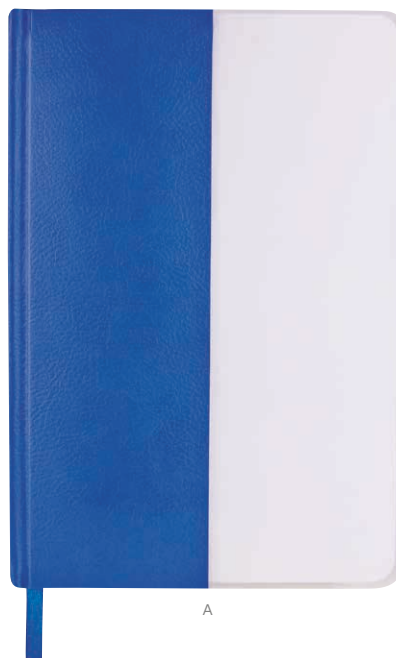

■ HL 050

LIBRETA **BICOLOR BILKA**

Material: Curpiel / Plástico
 Medida: 14 x 20.7 cm
 Área de Impresión: 5.5 x 19 cm
 Técnica de Impresión: Serigrafía / Termograbado
 Colores: A/N/R

■ ■ Colores GTM: A/N/R

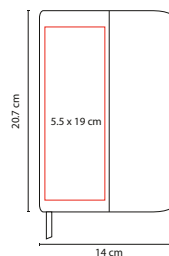

80 Hojas de raya. Incluye separador de hojas.



■ HL 170

LIBRETA **DOCTOR**

Material: Cartón / Espiral Metálico
 Medida: 17.2 x 21.5 cm
 Área de Impresión: 4.5 x 8 cm
 Técnica de Impresión: Serigrafía
 Colores: Blanco

■ ■ Colores GTM: Blanco

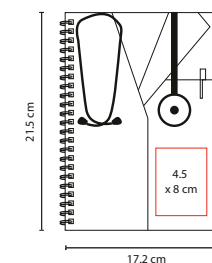

100 Hojas de raya. Con elástico para bolígrafo.
 No incluye bolígrafo.





O

ZEGNO®

■ HL 9010

LIBRETA ISAR

Material: Curpiel / Metal
 Medida: 12.7 x 21 cm
 Área de Impresión: 8 x 18 cm
 Técnica de Impresión: Serigrafía / Termograbado
 Tinta: Gel Negra
 Colores: A/O/R/V

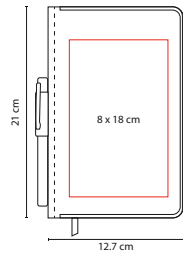

A

R

V

96 Hojas de raya. Con borde metálico para protección de extremos, incluye elástico y bolígrafo metálico.



Y

■ HL 2900

CUADERNO PROFESIONAL

Material: Cartón / Espiral Metálico
 Medida: 19.9 x 26.2 cm
 Área de Impresión: 16 x 23 cm
 Técnica de Impresión: Serigrafía
 Colores: A/N/O/R/V/Y

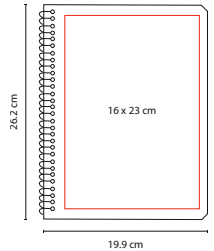

A

O

N

V

R

Cuaderno profesional tamaño carta. 70 Hojas de raya.

Z E G N O®



O

■ HL 2021

LIBRETA **SMYRNA**

Material: Curpiel
Medida: 14.2 x 21 cm
Área de Impresión: 10 x 15 cm
Técnica de Impresión: Serigrafía /
Termograbado
Colores: A/N/O/R/V

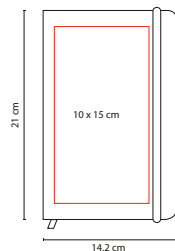

80 Hojas de raya. Incluye separador de hojas y elástico para cerrar.

Z E G N O®



A

■ HL 095

LIBRETA **DETIAN**

Material: Curpiel / Plástico
Medida: 9.8 X 14 cm
Área de Impresión: 5 x 10 cm
Técnica de Impresión: Serigrafía /
Termograbado
Tinta: Negra
Colores: A/N/R

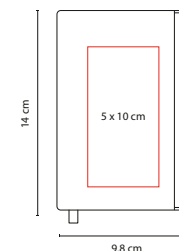

80 Hojas de raya. Incluye touch screen y bolígrafo.





V

HL 9060

LIBRETA NORLYS

Material: Curpiel
 Medida: 13 x 21 cm
 Área de Impresión: 11 x 19 cm
 Técnica de Impresión: Serigrafía /
 Termograbado
 Colores: A/N/O/R/V

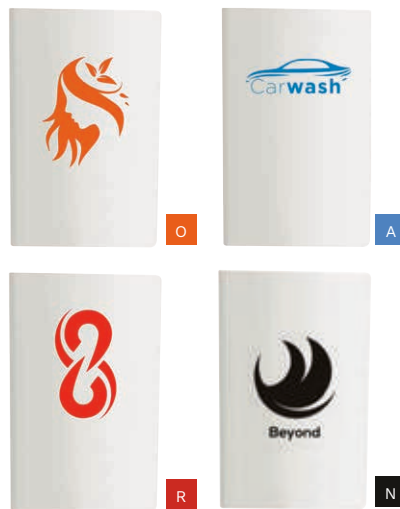
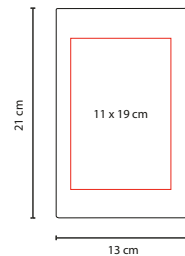

80 Hojas de raya.

Cubierta con recubrimiento interior de color para resaltar el logo una vez aplicado el termograbado.



N

ZEGNO®



HL 9030

LIBRETA ESVA

Material: Curpiel / Metal
 Medida: 14.5 x 21.4 cm
 Área de Impresión: 8 x 10 cm Cubierta /
 2.4 cm Broche Metálico
 Técnica de Impresión: Láser / Serigrafía /
 Goteado en Resina
 Colores: A/N/R

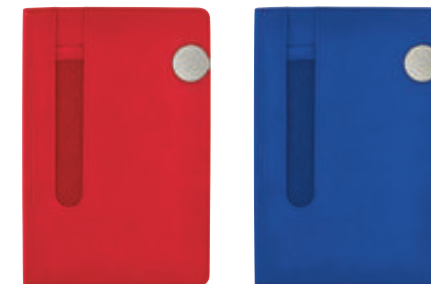
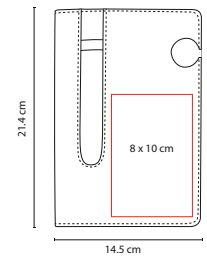

R

A

80 Hojas de raya. Incluye compartimento para bolígrafo y broche circular metálico imantado. No incluye bolígrafo.



R

HL 2080

LIBRETA SUAZI

Material: Curpiel / Plástico
 Medida: 13.5 x 21.5
 Área de Impresión: 8 x 10 cm
 Técnica de Impresión: Láser / Serigrafía / Termograbado
 Tinta: Negra
 Colores: A/N/R

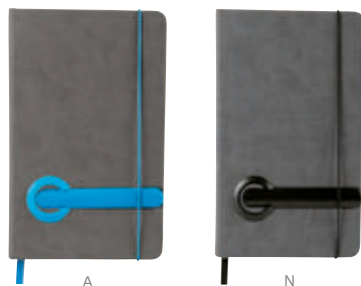
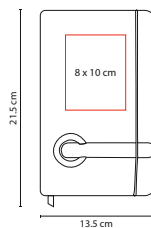

A

N

80 Hojas de raya. Incluye separador de hojas, bolígrafo de plástico y elástico para cerrar.



A

ZEGNO® HL 9020

LIBRETA ALIFAN

Material: Curpiel / Espiral Metálico
 Medida: 14.4 x 21 cm
 Área de Impresión: 8 x 10 cm
 Técnica de Impresión: Láser / Serigrafía / Termograbado
 Colores: A/N/R

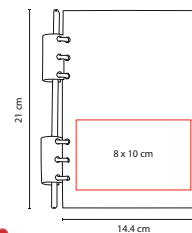

N

R

80 Hojas de raya.



N

ZEGNO® HL 1750

LIBRETA MACEO

Material: Curpiel
 Medida: 14.2 x 21 cm
 Área de Impresión: 6 x 4 cm
 Técnica de Impresión: Termograbado
 Colores: A/N/R

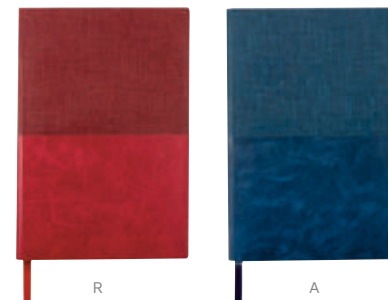
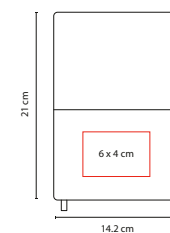

R

A

70 Hojas de raya. Incluye separador de hojas.





G

ZEGNO®

HL 9040

SET AITANA

Material: Tela / Metal
 Medida: 15.2 x 21.7 cm
 Área de Impresión: 4 x 2.5 cm
 Técnica de Impresión: Láser / Serigrafía
 Tinta: Negra
 Colores: G/N

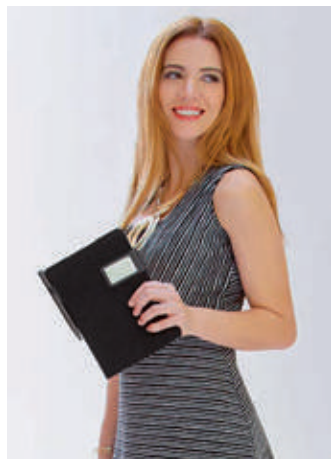
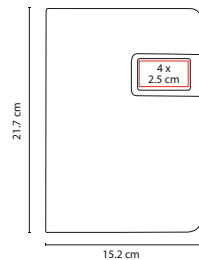

N

80 Hojas de raya. Incluye bolígrafo metálico tinta negra y caja de regalo.



R

ZEGNO®

HL 140

LIBRETA TREBBIA

Material: Curpiel / Metal
 Medida: 18 x 23 cm
 Área de Impresión: 7 x 10 cm
 Técnica de Impresión: Serigrafía /
 Termograbado
 Tinta: Negra
 Colores: A/N/R

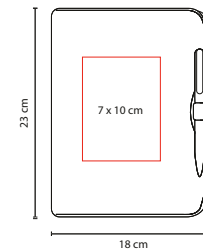

A



N

80 Hojas de raya. Libreta con bolígrafo metálico, compartimento para tarjetas y porta documentos.



N

ZEGNO®

■ HL 9015

LIBRETA QUERCUS

Material: Curpiel
 Medida: 14.5 cm x 21.5 cm
 Área de Impresión: 10 x 5 cm
 Técnica de Impresión: Láser /
 Serigrafía / Termograbado
 Colores: G/N
 ■ ■ Colores GTM: G/N

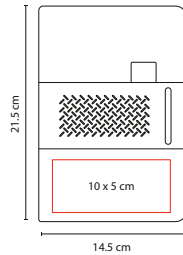

G

80 Hojas raya. Incluye elástico para bolígrafo y compartimento para tarjeta. No incluye bolígrafo.

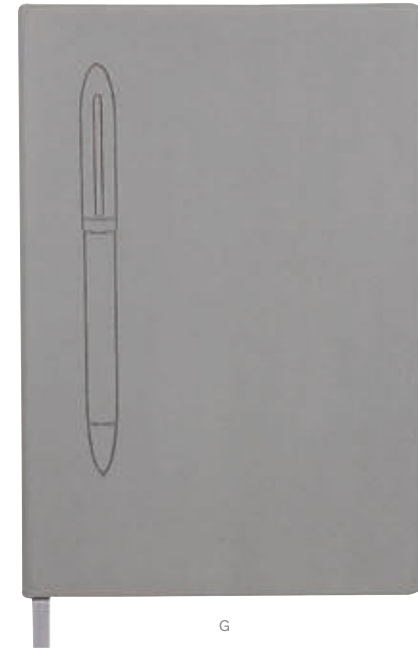

G

ZEGNO®

■ HL 9045

LIBRETA SAYAGO

Material: Curpiel
 Medida: 14.4 x 21 cm
 Área de Impresión: 7 x 17 cm
 Técnica de Impresión: Termograbado / Láser
 Colores: G/N

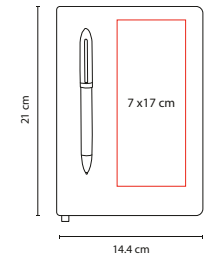

N

80 Hojas de raya.
 Cubierta con espacio imantado para bolígrafo metálico y separador de hojas. No incluye bolígrafo.





C

■ M 80900

LIBRETA LOUISIANA

Material: Curpiel
 Medida: 16.8 x 23.5 cm
 Área de Impresión: 12 x 6 cm
 Técnica de Impresión: Serigrafía /
 Termograbado
 Colores: C/N



N

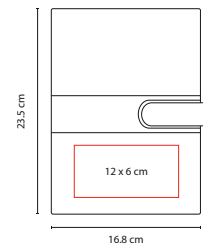

Incluye block de raya tamaño A5 con 88 hojas.
 Arillo de 3/4". No incluye bolígrafo.



A

Z E G N O® ■ HL 2060

LIBRETA ALTAIS

Material: Poliéster / Metal / Espiral Metálico
 Medida: 13 x 19 cm
 Área de Impresión: 7 x 5 cm Cubierta /
 1 x 1 cm en Placa Metálica
 Técnica de Impresión: Serigrafía /
 Láser en Placa Metálica
 Colores: A/G



G

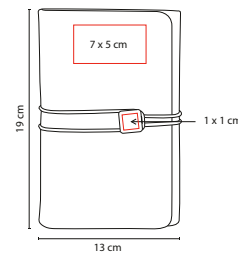

75 Hojas de raya. Incluye elástico para cerrar, placa para grabado, organizador de documentos y compartimento interior con cierre. No incluye bolígrafo.



G

Z E G N O® ■ HL 9025

LIBRETA BAVIERA

Material: Curpiel
 Medida: 15.4 x 21.2 cm
 Área de Impresión: 5 x 17 cm
 Técnica de Impresión: Láser
 Colores: G/N



N

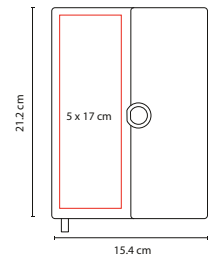

80 Hojas de raya. Incluye broche magnético y separador de hojas.



N

ZEGNO®

HL 160

LIBRETA MISCANTI



Material: Curpiel
 Medida: 20.5 x 26.5 cm
 Área de Impresión: 10 x 14 Cubierta /
 1 x 2.5 cm Placa
 Técnica de Impresión: Láser /
 Serigrafía / Termograbado
 Colores: C/N

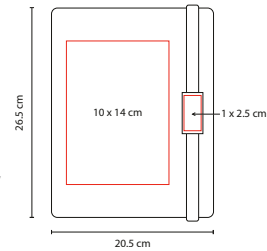

C

Libreta doble block con 96 hojas de raya (48 hojas en cada block).
 Incluye elástico con placa metálica para impresión.



ZEGNO®

HL 1800

LIBRETA FARA

Material: Curpiel / Metal
 Medida: 18 x 23.5 cm
 Área de Impresión: 10 x 15 cm
 Técnica de Impresión: Láser /
 Serigrafía / Termograbado
 Capacidad: 4 GB
 Tinta: Negra
 Colores: Negro
 Colores GTM: Negro

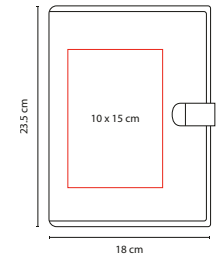

100 Hojas de raya tamaño esquila. Incluye bolígrafo metálico tinta negra y broche USB desprendible de 4 GB.
 Compartimento para tarjetas y documentos. Arillo de 1 pulgada. Incluye caja de regalo.





V



■ M 80230

CARPETA SKIN

Material: Cartón / Papel reciclado
 Medida: 23 x 31 cm
 Área de Impresión: 16 x 26.5 cm
 Técnica de Impresión: Serigrafía
 Tinta: Negra
 Colores: A/R/V

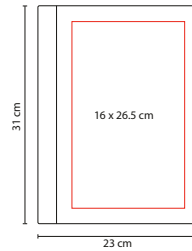

R



A

Carpeta ecológica. Incluye block de raya tamaño A4 con 30 hojas, bolígrafo y notas adheribles.



■ M 80200

CARPETA NATURE

Material: Cartón / Papel Reciclado
 Medida: 28.4 x 34.5 cm
 Área de Impresión: 18 x 26 cm
 Técnica de Impresión: Serigrafía
 Tinta: Negra
 Colores: Beige
 Colores GTM: Beige

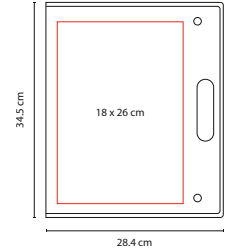

Carpeta ecológica. Incluye block de raya tamaño A4 con 20 hojas, bolígrafo y notas adheribles.



C

■ M 82400

SOBRE BEIRUT

Material: Curpiel
 Medida: 34 x 24.5 cm
 Área de Impresión: 20 x 9 cm
 Técnica de Impresión: Láser /
 Serigrafía / Termograbado
 Colores: C/N

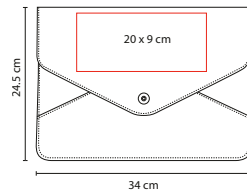

N

Sobre porta documentos con broche magnético.



■ M 80920

CARPETA PORTA TABLET LORY

Material: Curpiel
 Medida: 23.5 x 31.5 cm
 Área de Impresión: 10 x 29 cm
 Técnica de Impresión: Serigrafía / Termograbado
 Colores: Negro
 ■■ Colores GTM: Negro

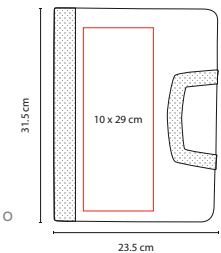

Incluye block de raya tamaño A4 con 20 hojas, elástico para bolígrafo, compartimento para documentos y tarjetas, asas, soporte y base para tablet y mini tablet. No incluye bolígrafo.



C

■ M 80800

CARPETA LISBOA

Material: Curpiel
 Medida: 24.4 x 31.6 cm
 Área de Impresión: 16 x 18 cm
 Técnica de Impresión: Serigrafía /
 Termograbado
 Colores: C/N

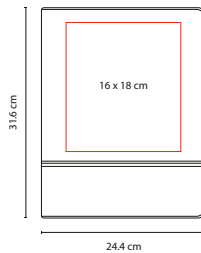

■ SIN 014

CARPETA PORTAFOLIO

Material: Curpiel
 Medida: 36.2 x 27.2 cm
 Área de Impresión: 28 x 16 cm
 Técnica de Impresión: Láser /
 Serigrafía
 Colores: Negro
 Colores GTM: Negro

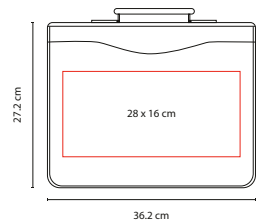

N



Incluye block de raya tamaño A4 con 20 hojas. No incluye bolígrafo.

Carpeta portafolio con block de raya tamaño A4 con 20 hojas.
 Arillo de 1.25 pulgadas. No incluye bolígrafo.



■ M 80170

CARPETA YAMDENA

Material: Curpiel / Vinil
Medida: 24.3 x 35 cm
Área de Impresión: 10 x 4 cm
Técnica de Impresión: Láser /
Serigrafía / Termograbado
Colores: Negro

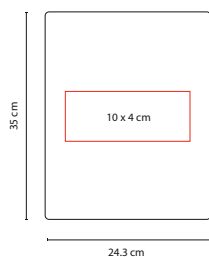

Incluye block de raya tamaño A4 con 20 hojas, espacio para bolígrafo y compartimento para documentos. No incluye bolígrafo.



■ M 80444

CARPETA CENTURY

Material: Curpiel
Medida: 24.6 x 31.6 cm
Área de Impresión: 16 x 7 cm
Técnica de Impresión: Serigrafía / Termograbado
Colores: Negro

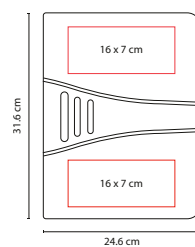

Incluye block de raya tamaño A4 con 20 hojas. No incluye bolígrafo.



■ M 82724

CARPETA HARBEL

Material: Curpiel
Medida: 24 x 31.5 cm
Área de Impresión: 16 x 25 cm
Técnica de Impresión: Serigrafía / Termograbado
Colores: Negro
■ ■ Colores GTM: Negro

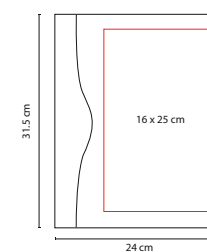

Incluye block de raya tamaño A4 con 20 hojas. No incluye bolígrafo.



■ M 80910

CAPERTA PORTA TABLET HAVAR

Material: Curpiel
 Medida: 20 x 24.5 cm
 Área de Impresión: 12 x 21 cm
 Técnica de Impresión: Serigrafía /
 Termograbado
 Colores: Negro
 Colores GTM: Negro

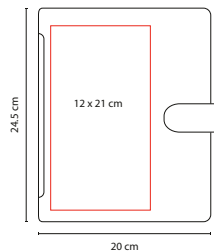

Incluye porta notas de raya con 20 hojas medida 8 x 10.5 cm, elástico para bolígrafo, compartimento para documentos y tarjetas, base con botón y elástico porta tablet. No incluye bolígrafo.



■ M 80150

CARPETA ONTARIO

Material: Curpiel
 Medida: 24 x 32 cm
 Área de Impresión: 15 x 29 cm
 Técnica de Impresión: Serigrafía /
 Termograbado
 Colores: Negro
 Colores GTM: Negro

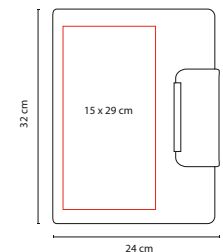

Incluye block de raya tamaño A4 con 20 hojas, elástico para bolígrafo, broche magnético, compartimento para documentos y tarjetas. No incluye bolígrafo.



■ M 6030

CARPETA NIROU

Material: Curpiel
Medida: 23.6 x 31.2 cm
Área de Impresión: 13 x 10 cm
Técnica de Impresión: Láser /
Serigrafía / Termograbado

Colores: Negro

■ ■ Colores GTM: Negro

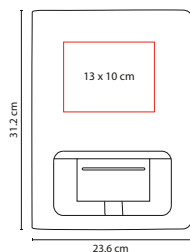

Incluye block de raya tamaño A4 con 20 hojas, elástico para bolígrafo, compartimento para smartphone, documentos y tarjetas. No incluye bolígrafo.



N

■ M 80770

CARPETA ENSHI

Material: Curpiel / Tela
Medida: 23.6 x 31 cm
Área de Impresión: 10 x 20 cm
Técnica de Impresión: Láser /
Serigrafía / Termograbado

Colores: G/N

■ ■ Colores GTM: Negro

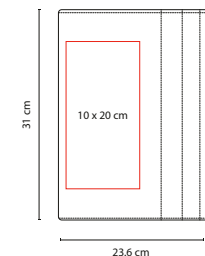

G

Incluye block de raya tamaño A4 con 20 hojas, elástico para bolígrafo, compartimento para documentos y tarjetas. No incluye bolígrafo.



■ M 81300

CARPETA RECORD

Material: Curpiel
 Medida: 26 x 33 cm
 Área de Impresión: 16 x 30 cm Curpiel /
 1 x 4 cm en Placa Metálica
 Técnica de Impresión: Láser /
 Serigrafía / Termograbado
 Colores: Negro
 ■ ■ Colores GTM: Negro

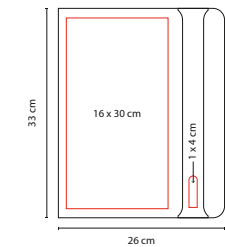

Carpeta con cierre y placa metálica.
 Incluye block de raya tamaño A4 con 20 hojas.
 Incluye elástico para bolígrafo. No incluye bolígrafo.



■ M 80850

CARPETA GIRAC

Material: Curpiel
 Medida: 24 x 31.2 cm
 Área de Impresión: 15 x 3 cm Curpiel /
 1.5 x 4 cm en Placa Metálica
 Técnica de Impresión: Láser en Placa Metálica /
 Serigrafía
 Colores: Negro

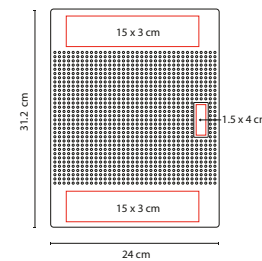

Incluye block de raya tamaño A4 con 20 hojas,
 elástico para bolígrafo y compartimento para tarjetas.
 No incluye bolígrafo.



■ M 80750

CARPETA MIRAM

Material: Poliéster
 Medida: 24 x 30.8 cm
 Área de Impresión: 13 x 22 cm Cubierta /
 3 x 2 cm en Placa Metálica
 Técnica de Impresión: Láser en Placa Metálica /
 Serigrafía
 Colores: Negro

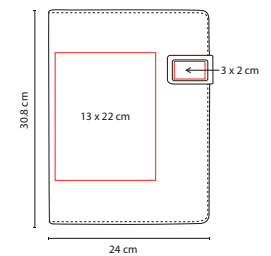

Incluye block de raya tamaño A4 con 20 hojas, elástico para bolígrafo,
 compartimento para smartphone y tarjetas. Broche magnético.
 No incluye bolígrafo.



A

■ M 6020

CARPETA HAEDI

Material: Curpiel / Poliéster
 Medida: 26.5 x 33.6 cm
 Área de Impresión: 10 x 8 cm
 Técnica de Impresión: Serigrafía /
 Termograbado
 Colores: A/G
 Colores GTM: A/G

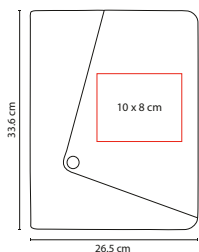

G

Incluye block de raya tamaño A4 con 20 hojas, elástico para bolígrafo, compartimento para smartphone, tablet y tarjetas. No incluye bolígrafo.



N

ZEGNO®

■ M 80940

CARPETA UYUNI

Material: Curpiel
 Medida: 23.5 x 31.1 cm
 Área de Impresión: 17 x 8 cm
 Técnica de Impresión: Láser /
 Serigrafía / Termograbado
 Colores: G/N

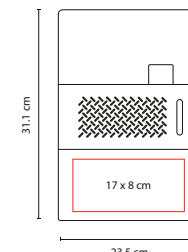

G

Incluye block de raya tamaño A4 con 20 hojas, elástico para bolígrafo, compartimento para documentos y tarjetas. No incluye bolígrafo.





ZEGNO®

■ M 80890

CARPETA TAWANG

Material: Tela / Silicón
 Medida: 23.2 x 31.1 cm
 Área de Impresión: 4 x 2.5 cm
 Técnica de Impresión: Láser
 Colores: Negro

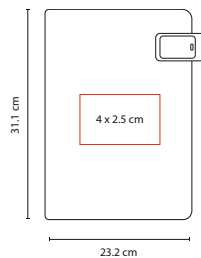

Incluye block de raya tamaño A4 con 20 hojas, elástico para bolígrafo, compartimento para smartphone, tablet y tarjetas. No incluye bolígrafo. Batería auxiliar para smartphone con capacidad 4000 mAh. Broche magnético.



■ M 80930

CARPETA NAUSSAC

Material: Curpiel
 Medida: 20.2 x 25.7 cm
 Área de Impresión: 9 x 7 cm
 Técnica de Impresión: Láser / Serigrafía / Termograbado
 Colores: Negro

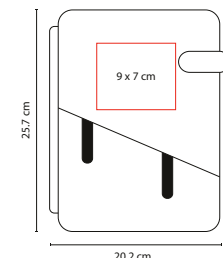

Cubierta con compartimento para bolígrafo, smartphone y audífonos. Incluye block de notas A5 con 20 hojas, compartimento para tarjetas y documentos, soporte para tablet y minitab. Batería auxiliar para smartphone con capacidad 5000 mAh. Cable adaptador compatible con 8 pin y micro USB. Broche magnético.

AGENDAS





AR

ZEGNO®

■ AGBT 019

AGENDA DE BOLSILLO TERRA

Material: Curpiel

Medida: 17.5 x 9 cm

Área de Impresión: 11 x 6 cm

Técnica de Impresión: Láser / Serigrafía / Termograbado

Colores: A/AR/M/O/P/R/V

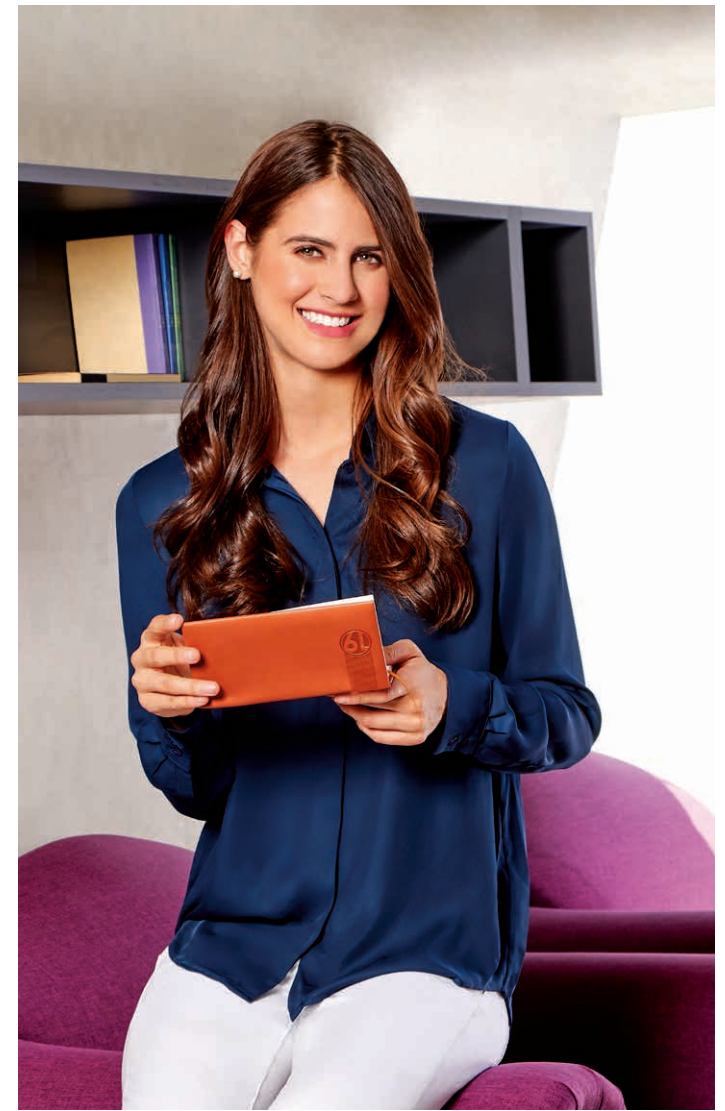
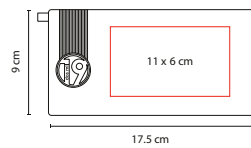

A



R



M



O



V



P

Contiene calendario 2019, calendarios 2018-2020, planeador 2019, tablas de conversión, claves de larga distancia nacional e internacional, horario internacional, agenda semanal con días festivos oficiales y directorio telefónico. Incluye caja individual.



R

ZEGNO®

AGT 019

AGENDA DIARIA **TERRA**

Material: Curpiel

Medida: 14 x 21 cm

Área de Impresión: 10 x 9 cm

Técnica de Impresión: Láser / Serigrafía /

Termograbado

Colores: A/AR/M/O/P/R/V

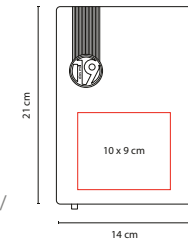

V



A



P



AR



O



M

Contiene calendarios 2018-2020, calendario 2019, planeador 2019, tablas de conversión, claves de larga distancia nacional e internacional, tabla de distancias, horario internacional, agenda diaria con días festivos oficiales, directorio telefónico y mapas. Incluye caja individual.



T

Z E G N O®

■ **AGB 019**

AGENDA DE BOLSILLO CLÁSICA

Material: Curpiel

Medida: 17,5 x 9 cm

Área de Impresión: 11 x 6 cm

Técnica de Impresión: Láser / Serigrafía / Termograbado

Colores: A/C/G/N/T/V

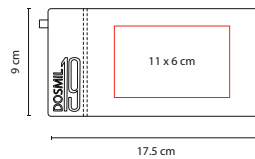

A



N



V



G



C

Contiene calendario 2019, calendarios 2018-2020, planeador 2019, programador anual, tablas de conversión, claves de larga distancia nacional e internacional, horario internacional, agenda semanal con días festivos oficiales y directorio telefónico. Incluye caja individual.



G

Z E G N O®

■ **AGD 019**

AGENDA DIARIA **CLÁSICA**

Material: Curpiel

Medida: 14 x 21 cm

Área de Impresión: 8 x 17 cm

Técnica de Impresión: Láser / Serigrafía /
Termograbado

Colores: A/C/G/N/T/V

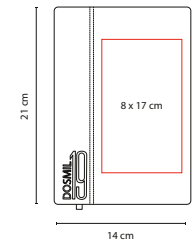

N



C



A



T



V

Contiene calendarios 2018-2020, calendario 2019, planeador 2019, programador anual, presupuesto de gastos, tablas de conversión, claves de larga distancia nacional e internacional, horario internacional, tabla de distancias, agenda diaria con días festivos oficiales, directorio telefónico y mapas. Incluye caja individual.



A

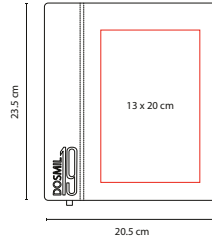
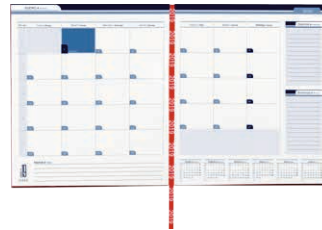

ZEGNO®

AGE 019

AGENDA EJECUTIVA CLÁSICA

Material: Curpiel

Medida: 20.5 x 23.5 cm

Área de Impresión: 13 x 20 cm

Técnica de Impresión: Láser / Serigrafía / Termograbado

Colores: A/C/G/N/T/V



C



V



T



N



G



Contiene calendarios 2018-2020, calendario 2019, planeador 2019, programador anual,

presupuesto de gastos, mantenimiento del automóvil, horario internacional, claves de larga distancia nacional e internacional, tablas de conversión, agenda semanal con días festivos oficiales, directorio telefónico y mapas. Incluye caja individual.



A



ZEGNO® ■ AGC 019

AGENDA DIARIA CADIER

Material: Curpiel
 Medida: 20.4 x 23 cm
 Área de Impresión: 9 x 19 cm Cubierta /
 0.8 x 3.5 cm Placa
 Técnica de Impresión: Láser / Serigrafía /
 Termograbado
 Tinta: Negra
 Colores: A/C/N

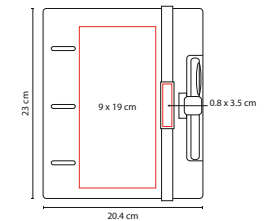

C



N

Agenda diaria con bolígrafo metálico y separador elástico con placa metálica para impresión. Compartimento para tarjetas y documentos. Arillo de 1 pulgada. Contiene calendarios 2018-2020, calendario 2019, planeador 2019, programador anual, presupuesto de gastos, tablas de conversión, claves de larga distancia nacional e internacional, horario internacional, tabla de distancias, agenda diaria con días festivos oficiales, directorio telefónico y mapas. Incluye caja individual.



N



ZEGNO®

■ AGU 019

AGENDA DIARIA USB VERALDI

Material: Curpiel
 Medida: 20.4 x 23 cm
 Área de Impresión: 8 x 9 cm
 Técnica de Impresión: Láser / Serigrafía / Termograbado
 Capacidad: 4 GB
 Tinta: Negra
 Colores: A/C/N

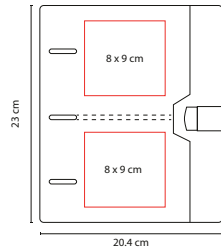

A



C

Agenda diaria con broche USB de 4 GB desprendible y bolígrafo metálico. Compartimento para tarjetas y documentos. Arillo de 1 pulgada. Contiene calendarios 2018-2020, calendario 2019, planeador 2019, programador anual, presupuesto de gastos, tablas de conversión, claves de larga distancia nacional e internacional, horario internacional, tabla de distancias, agenda diaria con días festivos oficiales, directorio telefónico y mapas. Incluye caja individual.

A man and a woman are standing outdoors in a wooded area. The man on the left is wearing a black zip-up jacket with grey accents on the sleeves and dark jeans. The woman on the right is wearing a grey zip-up hoodie, a red baseball cap, and dark pants. They are both smiling at the camera. The background consists of large tree trunks and a grassy area with some foliage.

TEXTILES



GORRAS Y SOMBREROS



AM

prakticasport



■ GEP 003

GORRA DE ALGODÓN

Material: Algodón

Talla: Unitalla

Circunferencia Interna: 57 cm

Área de Impresión: 10 x 4 cm

Técnica de Impresión: Bordado / Serigrafía

Colores: A/AM/B/K/N/O/R/V/Y

Colores GTM: A/B/K/R/V

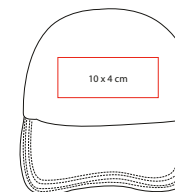

V



B



O



R



A



Y



N



K



Broche de velcro.



Y



O

prakticasport

■ GSP 002

GORRA SÁNDWICH

Material: Algodón
Talla: Unitalla

Circunferencia Interna: 57 cm
Área de Impresión: 5 x 4 cm

Técnica de Impresión: Bordado / Serigrafía
Colores: A/AR/G/K/N/P/R/V/W/Y

Colores GTM: A/AR/G/K/N/R/V/W/Y

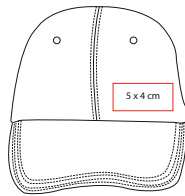

R



A



W



AR



P



G



N



V



K



Broche de velcro, sándwich del mismo color de la gorra.

prakticasport

■ CAP 005

GORRA RAINBOW

Material: Poliéster
Talla: Unitalla

Circunferencia Interna: 59 cm
Área de Impresión: 10 x 4 cm

Técnica de Impresión: Bordado / Serigrafía
Colores: A/B/N/O/R/V

Colores GTM: A/B/N/O/R/V



R



A



B



N



V

Broche de velcro.





G



■ CAP 012

VISERA BAYUDA

Material: Poliéster

Talla: Unitalla

Área de Impresión: 8 x 3 cm

Técnica de Impresión: Bordado

Colores: A/G/R

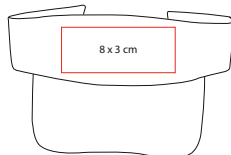

R



A



Visera elástica, cuenta con espacio para cabello.



A



■ CAP 006

VISERA SUMMER

Material: Poliéster

Talla: Unitalla

Circunferencia Interna: 57 cm

Área de Impresión: 11 x 3 cm

Técnica de Impresión: Bordado / Serigrafía

Colores: A/B/N/R

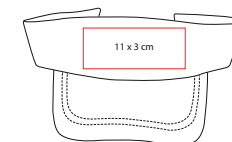

B



N



R

Broche de velcro.



Y

prakticasport.

COOL 001

GORRA COOL

Material: Poliéster

Talla: Unitalla

Circunferencia Interna: 59 cm

Área de Impresión: 5 x 4 cm

Técnica de Impresión: Bordado

Colores: A/B/N/O/R/V/Y

Colores GTM: A/B/N/O/R/V

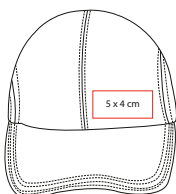

5 x 4 cm



N



A



O



V



R



B

Broche metálico.



O

prakticasport.

GMR 001

GORRA REFLECTIVE

Material: Microfibra / Malla

Talla: Unitalla

Circunferencia Interna: 57 cm

Área de Impresión: 8 x 6 cm

Técnica de Impresión: Bordado

Colores: A/B/N/O/P/R/V/Y

Colores GTM: A/B/N/R

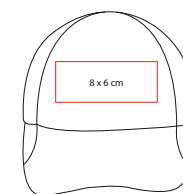

8 x 6 cm



V



Y



P



B



N



A

Broche de velcro.





Y



■ GEP 002

GORRA FLATCOLORS

Material: Poliéster

Talla: Unitalla

Circunferencia Interna: 56 cm

Área de Impresión: 10 x 4 cm

Técnica de Impresión: Bordado / Serigrafía

Colores: A/O/P/V/Y

■ Colores GTM: A/O/V

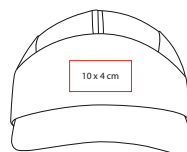

Gorra colores neón. Broche de velcro.



V



■ CAP 010

GORRA JASLO

Material: Poliéster

Talla: Unitalla

Circunferencia Interna: 57 cm

Área de Impresión: 9 x 4 cm

Técnica de Impresión: Bordado / Serigrafía

Colores: A/B/N/O/R/V/Y

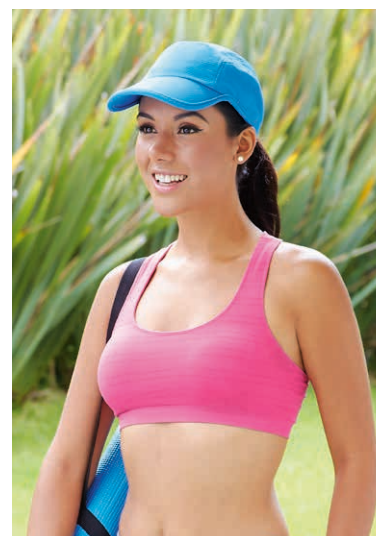
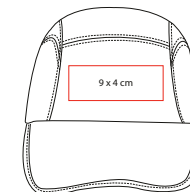

Gorra de malla con broche de velcro.



prakticasport ■ **CAP 004**

GORRA TRUCKER

Material: Poliéster / Red de Polipropileno
 Talla: Unitalla
 Circunferencia Interna: 57 cm
 Área de Impresión: 10 x 4 cm
 Técnica de Impresión: Bordado / Serigrafía
 Colores: A/B/N/O/R/V/Y



Broche de plástico.



prakticasport ■ **GEP 004**

GORRA KILMORE

Material: Algodón
 Talla: Unitalla
 Circunferencia Interna: 58 cm
 Área de Impresión: 10 x 4 cm
 Técnica de Impresión: Bordado / Serigrafía
 Colores: A/O/R/V

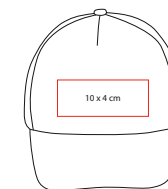

Gorra bicolor con broche de velcro.





OX



■ CAP 007

GORRA EVONY



Material: Algodón Jersey
Talla: Unitalla

Circunferencia Interna: 57 cm

Área de Impresión: 5 x 4 cm

Técnica de Impresión: Bordado / Serigrafía

Colores: G/OX

■ Colores GTM: G/OX

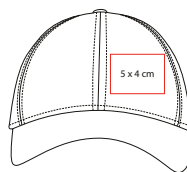

G



Broche de velcro.



O



■ CAP 008

GORRA NAIROBI



Material: Algodón
Talla: Unitalla

Circunferencia Interna: 57 cm

Área de Impresión: 5 x 4 cm

Técnica de Impresión: Bordado / Serigrafía

Colores: A/O/R/V/Y

■ Colores GTM: A/O/R/V/Y

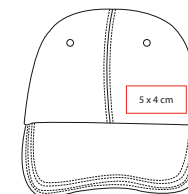

A



Y



R



V

Gorra deslavada bicolor con broche de velcro.



A

prakticasport

■ GEP 006

GORRA AVADI

Material: Poliéster

Talla: Unitalla

Circunferencia Interna: 56 cm

Área de Impresión: 5 x 4 cm

Técnica de Impresión: Bordado / Serigrafía

Colores: A/G/N/R

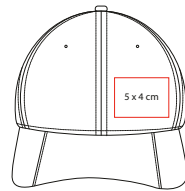

Broche metálico.



R

prakticasport

■ CAP 011

GORRA PALAWAN

Material: Algodón / Poliéster

Talla: Unitalla

Circunferencia Interna: 57 cm

Área de Impresión: 8 x 4 cm

Técnica de Impresión: Bordado / Serigrafía

Colores: A/G/R



Gorra de un panel.





N

prakticasport

GEP 001

GORRA STINSON

Material: Algodón
Talla: Unitalla

Circunferencia Interna: 58 cm

Área de Impresión: 5 x 4 cm

Técnica de Impresión: Bordado / Serigrafía

Colores: A/N/R

Colores GTM: A/R

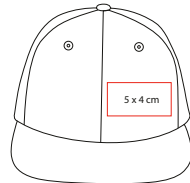

A

R

Gorra bicolor con visera plana. Broche de plástico.



prakticasport

CAP 020

GORRA WHISTLER

Material: Algodón
Talla: Unitalla

Circunferencia Interna: 56 cm

Área de Impresión: 5 x 4 cm Gorra /

2 x 1 cm Destapador

Técnica de Impresión: Bordado /

Serigrafía / Láser

Colores: Negro

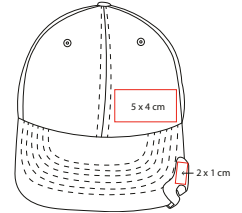

Visera con destapador. Broche de velcro.

Kprakticasport

GORRA BLUETOOTH
CAP 009



TEXTILES



GORRAS Y SOMBREROS

3W PROMIO
01 opcion

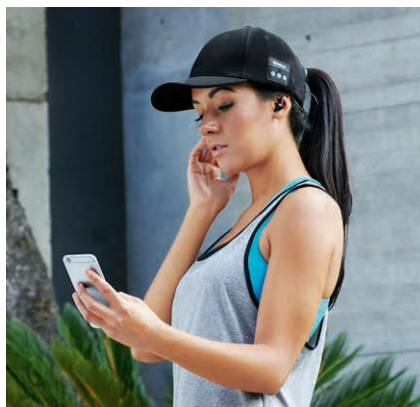

Kprakticasport

CAP 009

GORRA BLUETOOTH

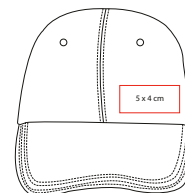

Material: Nylon
Talla: Unitalla
Circunferencia Interna: 57 cm
Área de Impresión: 5 x 4 cm
Técnica de Impresión: Bordado / Serigrafía
Colores: Negro
Colores GTM: Negro



Gorra con audifonos bluetooth, reproductor de audio y llamada con manos libres.
Incluye cable USB y batería de litio recargable. Broche de velcro.



prakticasport.

HAT 003

SOMBRERO MOJAVE



Material: Algodón

Talla: Unitalla

Circunferencia Interna: 58 cm

Área de Impresión: 11 x 1.5 cm

Técnica de Impresión: Bordado / Serigrafía

Colores: Beige

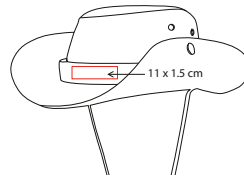

Incluye cordón ajustable y cinta removible



prakticasport.

HAT 002

SOMBRERO JUNO

Material: Paja de Papel

Talla: Unitalla

Circunferencia Interna: 57 cm

Área de Impresión: 15 x 1.5 cm

Técnica de Impresión: Bordado / Serigrafía

Colores: Beige

Colores GTM: Beige

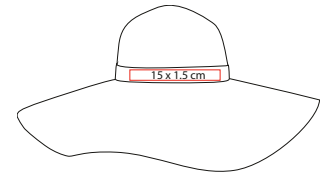

Cinta removible en color beige con broche de velcro.



R



■ PLY 008

PLAYERA CUELLO REDONDO VITIM

Material: 100% Algodón

Talla: CH/M/G/EG/2EG

Área de Impresión: 30 x 30 cm

Técnica de Impresión: Bordado / Serigrafía

Tipo: Cuello Redondo

Colores: A/B/N/R



N



B



A

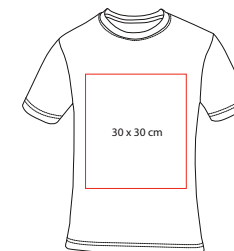

Playera unisex cuello redondo con manga corta y tapa costura, peso 165 gr/m².

TEXTILES



PLAYERAS

30 años
de
experiencia
en
promoción

246



G

**prakticasport****PLY 009**

PLAYERA POLO LUTRY

Material: 50% Algodón Peinado /
50% Poliéster

Talla: CH/M/G/EG/2EG

Área de Impresión: 12 x 10 cm

Técnica de Impresión: Bordado / Serigrafía

Tipo: Polo

Colores: A/B/G/R

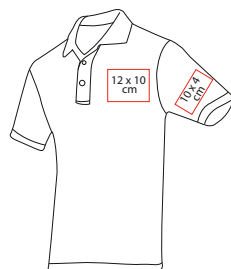

B



R



A

Playera tipo polo piqué para caballero y con tapa costura, peso 225 gr/m².



V

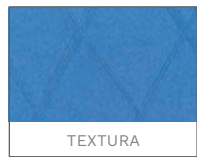

TEXTURA



■ PLY 002

PLAYERA YAGER

Material: 100% Poliéster Ecológico

Talla: CH/M/G/XL

Área de Impresión: 12 x 10 cm

Técnica de Impresión: Bordado / Serigrafía

Tipo: Polo

Colores: A/B/N/V

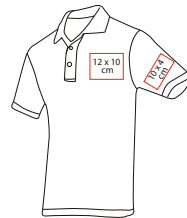

N



B



A



Tecnología KEEP DRY:
te mantiene fresco y cómodo.

- Tela COOL COMFORT, repele la humedad manteniéndola fresca, seca, suave y cómoda.
- Perdurable lavada tras lavada.
- Fibra fabricada a partir de poliéster reciclado, ayudando a la conservación de los recursos naturales.

Diseño de rombos.



D

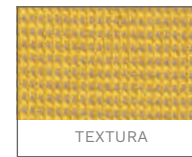

TEXTURA



■ PLY 004

PLAYERA CLASBENT

Material: 52% Poliéster / 48% Bambú

Talla: CH/M/G/XL

Área de Impresión: 12 x 10 cm

Técnica de Impresión: Bordado / Serigrafía

Tipo: Polo

Colores: D/N/S

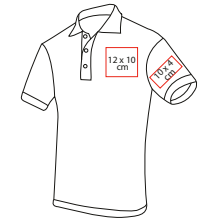

S



N

Alta Tecnología
4 en 1



- Tela COOL COMFORT, repele la humedad manteniéndola fresca, seca, suave y cómoda.
- Perdurable lavada tras lavada.

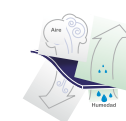

Tecnología KEEP DRY:
te mantiene fresco y cómodo.

Diseño de puntos, con protección UV UPF 25.



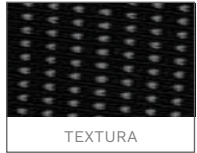

TEXTURA



N



PLY 006

PLAYERA FARELL

Material: 52% Poliéster / 48% Bambú

Talla: CH/M/G/XL

Área de Impresión: 10 x 8 cm

Técnica de Impresión: Bordado / Serigrafía

Tipo: Polo

Colores: D/N/S

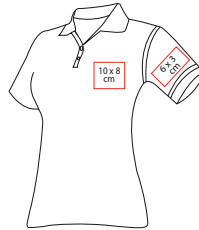

S



D

<p>Alta Tecnología 4 en 1</p> <ul style="list-style-type: none"> PERMEABLE PROTECCIÓN UV UPF 25 ANTIBACTERIAL ANTIESTÁTICA 	<ul style="list-style-type: none"> Tela COOL COMFORT, repele la humedad manteniéndola fresca, seca, suave y cómoda. Perdurable lavada tras lavada. 	<p>Tecnología KEEP DRY: te mantiene fresco y cómodo.</p>
--	--	--

Playera para dama. Diseño de puntos, con protección UV UPF 25.

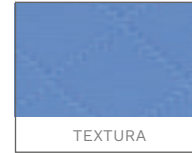

TEXTURA



A



PLY 005

PLAYERA RAVEL

Material: 100% Poliéster Ecológico

Talla: CH/M/G/XL

Área de Impresión: Bordado x 8 cm

Técnica de Impresión: Bordado / Serigrafía

Tipo: Polo

Colores: A/B/N/V

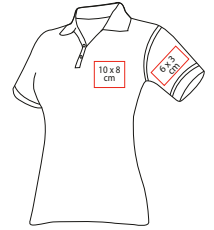

N



B



V

<p>Tecnología KEEP DRY: te mantiene fresco y cómodo.</p>	<ul style="list-style-type: none"> Tela COOL COMFORT, repele la humedad manteniéndola fresca, seca, suave y cómoda. Perdurable lavada tras lavada. Fibra fabricada a partir de poliéster reciclado, ayudando a la conservación de los recursos naturales.
--	--

Playera para dama. Diseño de rombos pequeños.

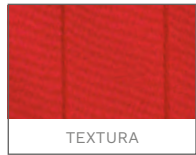

TEXTURA

B

prakticasport

PLY 001

PLAYERA FOSTER

Material: 100% Poliéster Ecológico

Talla: CH/M/G/XL

Área de Impresión: 12 x 10 cm

Técnica de Impresión: Bordado / Serigrafía

Tipo: Polo

Colores: B/N/R



N



R



Tecnología KEEP DRY:
te mantiene fresco y cómodo.

- Tela COOL COMFORT, repele la humedad manteniéndola fresca, seca, suave y cómoda.
- Perdurable lavada tras lavada.
- Fibra fabricada a partir de poliéster reciclado, ayudando a la conservación de los recursos naturales.

Diseño a rayas verticales.



TEXTURA

A

prakticasport

PLY 003

PLAYERA SORRELL

Material: 71% Poliéster / 29% Bambú

Talla: CH/M/G/XL

Área de Impresión: 12 x 10 cm

Técnica de Impresión: Bordado / Serigrafía

Tipo: Polo

Colores: A/B

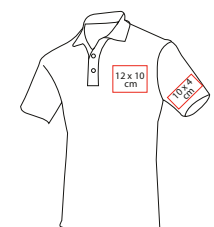

B

Alta Tecnología
4 en 1



PERMEABLE



PROTECCIÓN UV



ANTIBACTERIAL



ANTIFUNGICA

- Tela COOL COMFORT, repele la humedad manteniéndola fresca, seca, suave y cómoda.
- Perdurable lavada tras lavada.

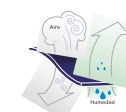

Tecnología KEEP DRY:
te mantiene fresco y cómodo.

Diseño de rayas horizontales con protección UV UPF 25.





A



■ CHM 009

CHALECO AVALON

Material: Nylon / Poliéster

Talla: M/L/XL

Área de Impresión: 12 x 10 cm

Técnica de Impresión: Bordado / Serigrafía

Colores: A/N/R

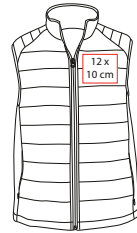

R



N



■ SEC 001

CHALECO DE SEGURIDAD SIKKER

Material: Poliéster

Talla: Unitalla

Área de Impresión: 30 x 20 cm

Técnica de Impresión: Serigrafía /

Bordado

Colores: Amarillo Fluorescente

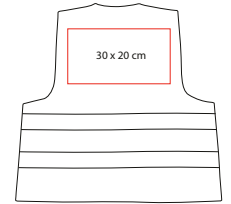

REVERSO

Chaleco ligero con bolsas laterales. Exterior 100% nylon. Interior y relleno 100% poliéster.

Chaleco de seguridad con doble cinta reflejante.



AM



■ CHM 012

CHAMARRA CUDMORE

Material: Algodón / Poliéster

Talla: M/L/XL

Área de Impresión: 12 x 10 cm

Técnica de Impresión: Bordado / Serigrafía

Colores: AM/G/N

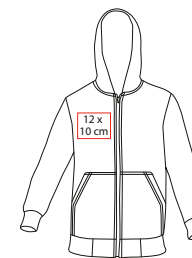

N



G

TEXTILES



CHAMARRAS Y CHALECOS

30% PROMOCION
0% opcion

Sudadera con capucha, cierre en medio y bolsas frontales. Composición: Algodón 70%, poliéster 30%.



prakticasport

■ **CHM 011**

CHAMARRA **ATHLONE**

Material: Nylon / Spandex

Talla: M/L/XL

Área de Impresión: 12 x 10 cm

Técnica de Impresión: Bordado / Serigrafía

Colores: Negro con Gris



Chamorra sport con capucha removible.

Bolsas laterales con cierre y compartimento al frente con cierre. Jaretas en capucha y cintura.

Línea reflejante en cierre principal. Composición 90% Nylon, 10% spandex.



R



■ CHM 010

CHAMARRA NORFOLK

Material: Poliéster / Nylon

Talla: M/L/XL

Área de Impresión: 12 x 10 cm

Técnica de Impresión: Bordado / Serigrafía

Colores: A/N/R



N



A



REVERSO

TEXTILES



CHAMARRAS Y CHALECOS



Chamarras con bolsos laterales y bolsos al interior. Exterior 100% nylon. Interior y relleno 100% poliéster.



N



■ CHM 008

SUDADERA ALASKA

Material: Poliéster

Talla: M/L/XL

Área de Impresión: 12 x 10 cm

Técnica de Impresión: Bordado / Serigrafía

Colores: A/N/R

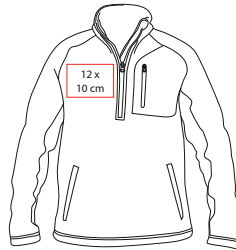

R



A

Sudadera micro polar 100% poliéster con bolsas laterales y cierre frontal.



A



■ CHM 007

CHAMARRA MANCHESTER

Material: Poliéster

Talla: M/L

Área de Impresión: 12 x 10 cm

Técnica de Impresión: Bordado / Serigrafía

Colores: A/R/S

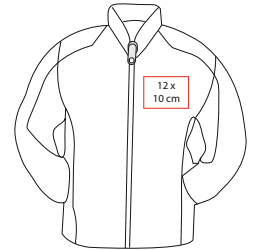

S



R



REVERSO

Con bolsas laterales y gorro.





P A R A G U A S E I M P E R M E A B L E



A

■ IMP 001

IMPERMEABLE GRISEL

Material: Plástico
 Medida: 6.3 cm Diámetro
 Área de Impresión: 3.5 x 3.5 cm
 Técnica de Impresión: Tampografía
 Colores: A/B/R
 ■ Colores GTM: Blanco

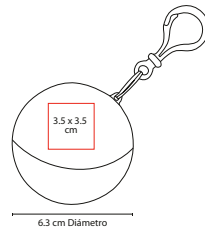

R

B



V

■ PAR 012

PARAGUAS ZLIN

Material: Poliéster
 Medida: 93 cm Diámetro /
 23.5 cm Cerrado
 Área de Impresión: 15 x 20 cm
 Técnica de Impresión: Serigrafía
 Colores: A/N/O/R/V

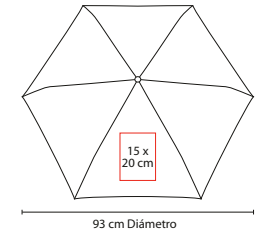

N

R

O

A

Incluye impermeable de plástico transparente. Estuche redondo con gancho de plástico.

Manual. 6 Paneles y mango de plástico. Incluye funda.



B



■ PAR 01

PARAGUAS CON FUNDA

Material: Poliéster
 Medida: 100 cm Diámetro
 Área de Impresión: 15 x 30 cm
 Técnica de Impresión: Serigrafía
 Colores: A/B/N/O/R/V/Y

■ Colores GTM: A/B/N/O/R/V/Y

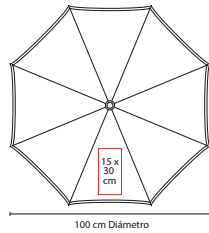

R

■ PAR 016

PARAGUAS SABETTA

Material: Poliéster
 Medida: 94 cm Diámetro
 Área de Impresión: 12 x 27 cm
 Técnica de Impresión: Serigrafía
 Colores: A/N/O/P/R/V/Y

■ Colores GTM: A/N/O/R/V

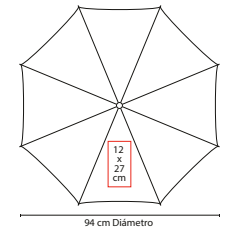

Automático. 8 Paneles y mango de EVA. Incluye funda con agarradera.



Automático. 8 Paneles y mango de plástico.





■ PAR 014

PARAGUAS MURITZ

Material: Poliéster
 Medida: 108 x 108 cm
 Área de Impresión: 15 x 30 cm
 Técnica de Impresión: Serigrafía
 Colores: A/O/R/V

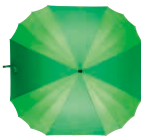
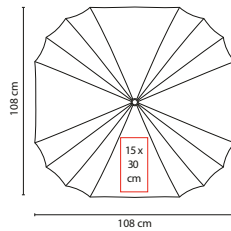

Automático. 16 Paneles y mango de plástico con carabina. Incluye funda con agarradera.



■ PAR 03

PARAGUAS CUADRADO

Material: Poliéster
 Medida: 98 x 98 cm
 Área de Impresión: 14 x 30 cm
 Técnica de Impresión: Serigrafía
 Colores: A/N/O/R/V/Y

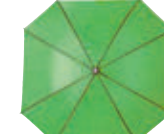
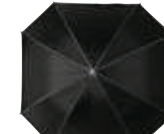
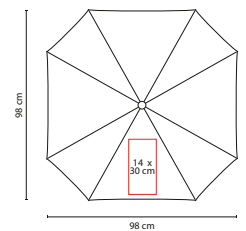

Automático. 8 Paneles y mango de plástico. Incluye cordón.



A



■ PAR 09

PARAGUAS ELGIN

Material: Poliéster

Medida: 105 cm Diámetro

Área de Impresión: 14 x 30 cm

Técnica de Impresión: Serigrafía

Colores: A/R/V

Colores GTM: A/R/V

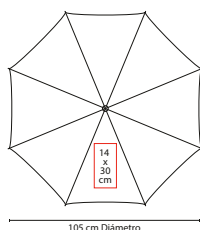

105 cm Diámetro



P



■ PAR 07

PARAGUAS DIFUMINADO BERANE

Material: Poliéster

Medida: 106 cm Diámetro

Área de Impresión: 14 x 30 cm

Técnica de Impresión: Serigrafía

Colores: A/O/P/R/V

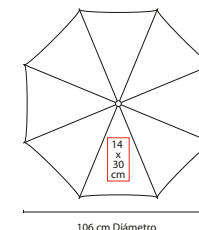

106 cm Diámetro



Automático. 8 Paneles y mango de plástico. Incluye funda con agarradera.

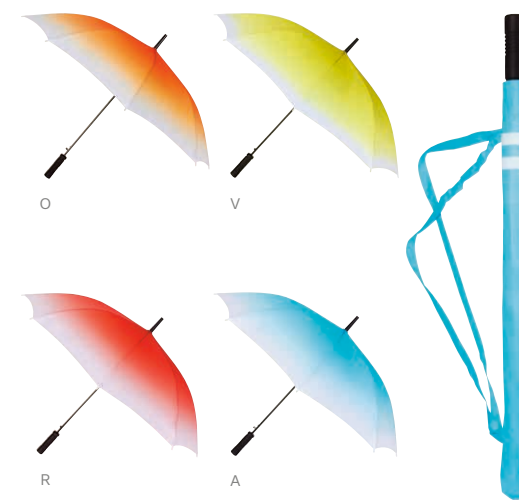

Automático. 8 Paneles y mango de EVA. Incluye funda con agarradera.





A



■ PAR 05

PARAGUAS **SILVER TROPIC**

Material: Poliéster
 Medida: 100 cm Diámetro
 Área de Impresión: 15 x 30 cm
 Técnica de Impresión: Serigrafía
 Colores: A/N/O/R/V
 Colores GTM: A/N/O/R/V

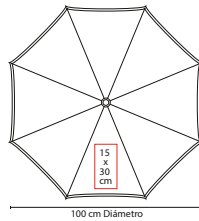

V



O



R



N



Automático. 8 Paneles y mango de EVA. Incluye funda.



■ PAR 06

PARAGUAS **CHARLESTON**

Material: Poliéster
 Medida: 127 cm Diámetro
 Área de Impresión: 22 x 25 cm
 Técnica de Impresión: Serigrafía
 Colores: Blanco con Negro

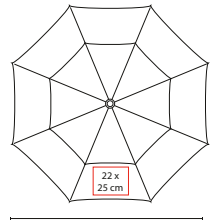

Automático. 8 Paneles dobles y mango de EVA. Incluye funda con agarradera.



■ PAR 013

PARAGUAS **BENUE**

Material: Poliéster
Medida: 100 cm Diámetro
Área de Impresión: 14 x 30 cm
Técnica de Impresión: Serigrafía
Colores: Negro con Plata

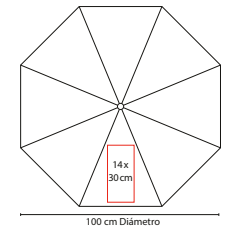

Paraguas con ventilador integrado. Manual, 8 paneles, mango de plástico con correa y funda con agarradera. No incluye baterías (4 pilas AA).

TEXTILES



PARAGUAS E IMPERMEABLE





■ **PAR 015**

PARAGUAS KADEI

Material: Poliéster

Medida: 105 cm Diámetro

Área de Impresión: 14 x 30 cm

Técnica de Impresión: Serigrafía

Colores: Negro con Gris

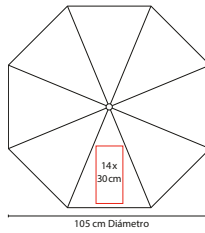

Paraguas reversible. Manual, 8 paneles dobles y mango de plástico. Incluye funda con agarradera.

HIELERAS Y LONCHERAS



■ SIN 129

LONCHERA LILLE

Material: Poliéster
 Medida: 14.5 x 34.5 x 13 cm
 Área de Impresión: 10 x 15 cm
 Técnica de Impresión: Serigrafía
 Colores: A/N/O/R/V
 Colores GTM: A/R/V

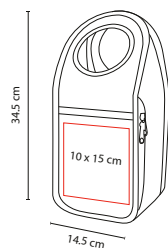

R



V



N



A



O

Interior metalizado. Broche de velcro.



R



■ SIN 066

LONCHERA EVENKI

Material: Poliéster

Medida: 27 x 20 x 19 cm

Área de Impresión: 20 x 14 cm

Técnica de Impresión: Bordado / Serigrafía

Colores: A/N/R

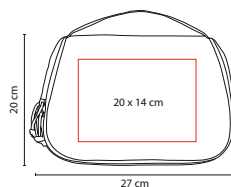

N



A

Interior metalizado. Abre completamente para facilitar impresión.



toSSH®

■ SIN 122

LONCHERA OPOL

Material: Poliéster

Medida: 22 x 25 x 15 cm

Área de Impresión: 8 x 11 cm

Técnica de Impresión: Serigrafía

Colores: Negro con Gris

■ Colores GTM: Negro con Gris

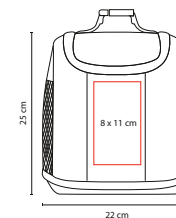

Interior plastificado. Cuenta con compartimentos superior e inferior. Incluye bolsas laterales de red y broche.



0

SIN 153

LONCHERA ATLANTA

Material: Non Woven
 Medida: 18 x 29 x 9 cm
 Área de Impresión: 10 x 10 cm
 Técnica de Impresión: Serigrafía
 Colores: A/N/O/R/V

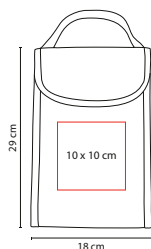

Interior metalizado.



SIN 127

LONCHERA NIKY

Material: Poliéster
 Medida: 19.5 x 23 x 10 cm
 Área de Impresión: 11 x 4 cm
 Técnica de Impresión: Serigrafía
 Colores: Gris
 Colores GTM: Gris

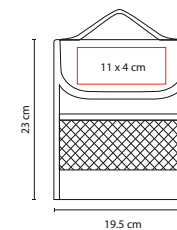

Interior metalizado. Incluye bolsa frontal de malla.





N

■ **SIN 152**

LONCHERA LEIRA

Material: Non Woven
 Medida: 28 x 19.5 cm
 Área de Impresión: 15 x 10 cm
 Técnica de Impresión: Serigrafía
 Colores: A/N/O/R/V

☑ Colores GTM: A/N/O/R/V

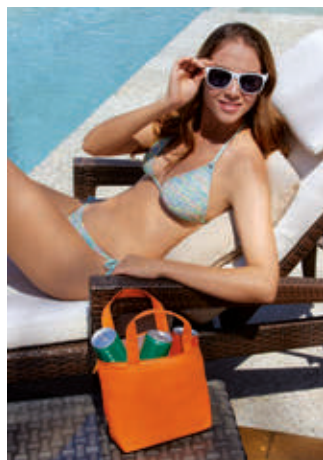
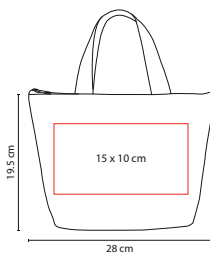

Interior metalizado.



R

■ **SIN 156**

LONCHERA ZIAR

Material: Non Woven
 Medida: 20 x 12.5 x 14 cm
 Área de Impresión: 11 x 5 cm
 Técnica de Impresión: Serigrafía
 Colores: A/N/O/R/V

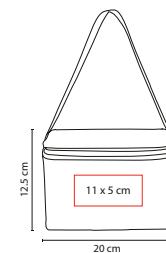

Interior metalizado.



Y

■ SIN 057

HIELERA KOSTA

Material: Poliéster
 Medida: 20.5 x 14.5 x 13 cm
 Área de Impresión: 12 x 8 cm
 Técnica de Impresión: Serigrafía
 Colores: A/N/O/R/V/Y

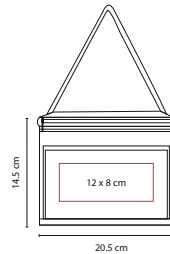

Interior plastificado impermeable. Incluye bolsa frontal.



A

■ SIN 450

LONCHERA ACTIVE

Material: Poliéster
 Medida: 21 x 15 cm
 Área de Impresión: 16 x 9 cm
 Técnica de Impresión: Serigrafía
 Colores: A/N/R

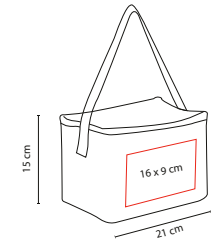

Interior metalizado.





V



SIN 067

LONCHERA TALSÍ

Material: Yute
 Medida: 21 x 15 x 12 cm
 Área de Impresión: 13 x 7 cm
 Técnica de Impresión: Serigrafía
 Colores: A/O/R/V
 Colores GTM: A/O/R/V

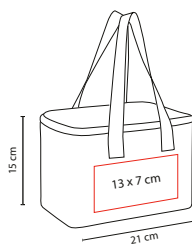

O

SIN 124

LONCHERA JESEL

Material: Poliéster
 Medida: 20 x 17 cm
 Área de Impresión: 14 x 9 cm
 Técnica de Impresión: Serigrafía
 Colores: A/N/O/R/V
 Colores GTM: A/R/V

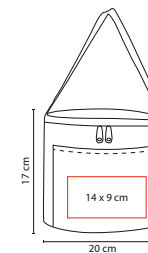

Interior metalizado. Bolsa frontal.



R

■ KTC 028

LONCHERA **BALDER**

Material: Plástico
Medida: 25 x 14 cm

Área de Impresión: 7 x 7 cm
Técnica de Impresión: Serigrafía
Colores: B/O/R/V

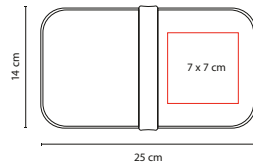

O



V



B

Lonchera de dos compartimentos y sujetador de silicón.



A

■ KTC 023

LONCHERA **LUCERNA**

Material: Poliéster / Plástico
Medida: 24 x 17 cm Lonchera Plástico /
25 x 23 x 11 cm Lonchera Poliéster

Área de Impresión: 15 x 8 cm Lonchera Plástico /
16 x 16 cm Lonchera Poliéster
Técnica de Impresión: Serigrafía
Colores: A/R

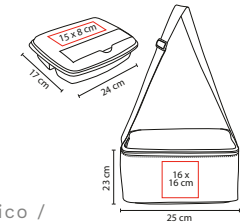

R

Set de hielera y lonchera de plástico con tenedor y cuchillo.





R

■ SOC 078

LONCHERA GOL

Material: Plástico
 Medida: 19 x 23.3 cm
 Área de Impresión: 6 x 6 cm
 Técnica de Impresión: Serigrafía
 Colores: A/B/R/V

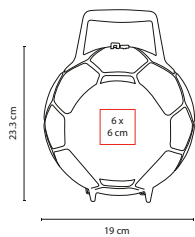

B

A

V



A

■ KTC 032

LONCHERA SELK

Material: Plástico
 Medida: 15.5 x 14 x 6 cm
 Área de Impresión: 7 x 7 cm
 Técnica de Impresión: Serigrafía
 Colores: A/B/O/R/V

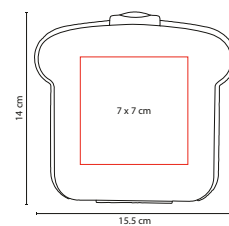

O

B



V

R



■ KTC 015

PORTAVIANDAS SENYA

Material: Plástico / Acero Inoxidable
 Medida: 17 x 14.5 cm
 Área de Impresión: 6 x 3 cm
 Técnica de Impresión: Serigrafía / Tampografía
 Colores: Blanco

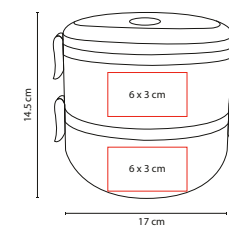

Incluye dos recipientes para alimentos.
 Compartimento superior para líquidos e inferior para sólidos.
 Con agarradera doble, válvula de silicón y broches sujetadores.



O

■ KTC 031

LONGHERA DENALI

Material: Plástico / PET
 Medida: 26.6 x 19.5 x 7.8 cm
 Área de Impresión: 13 x 10 cm
 Técnica de Impresión: Serigrafía / Tampografía
 Colores: A/O/R/V
 Colores GTM: A/O/R/V

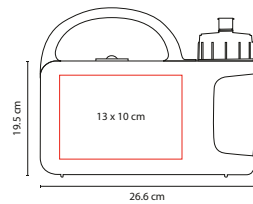

V



R



A



Compartimento principal para alimentos y espacio para cilindro de 500 ml. Incluye cilindro.



V



■ KTC 008

LONGHERA BENTO

Material: Plástico
 Medida: 22 x 5.5 cm
 Área de Impresión: 5 x 2 cm
 Técnica de Impresión: Serigrafía
 Colores: A/B/O/R/V
 Colores GTM: A/B/O/R/V

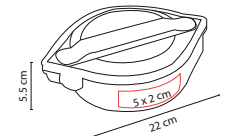
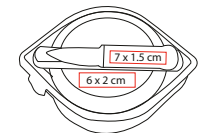

A



B



O



R

Incluye portacubiertos con cuchara, tenedor y cuchillo. 3 Compartimentos.





tossh

■ **SIN 312**

LONGHERA HAVASU

Material: Poliuretano / Poliéster
 Medida: 23 x 23 x 10 cm
 Área de Impresión: 12 x 12 cm
 Técnica de Impresión: Serigrafía
 Colores: Negro

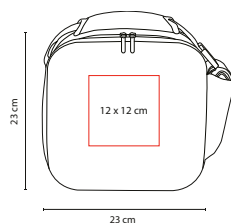

Cierre frontal y trasero. Bolsa lateral con broche velcro.
 Bolsa interna de malla. Incluye correa para colgar en hombros.



■ **SIN 007**

HIELERA 2 SIX

Material: Poliéster
 Medida: 30 x 17 x 23 cm
 Área de Impresión: 20 x 8.5 cm
 Técnica de Impresión: Serigrafía
 Colores: A/N/T
 Colores GTM: A/N/T

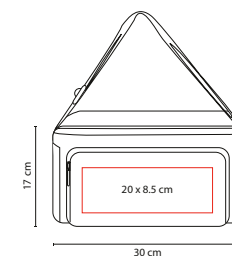

Interior metalizado plastificado e impermeable. Bolsa frontal.



N

toSSH

■ **SIN 126**

HIELERA BALTU

Material: Poliéster

Medida: 37 x 26 x 22 cm

Área de Impresión: 20 x 10 cm

Técnica de Impresión: Serigrafía

Colores: A/N/R

■ ■ Colores GTM: Negro con Gris

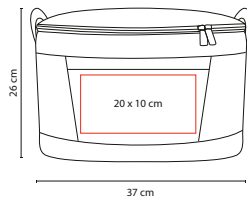

R

■ **SIN 245**

LONCHERA LEDU

Material: Poliéster

Medida: 24 x 24 x 17 cm

Área de Impresión: 11 x 7 cm

Técnica de Impresión: Serigrafía

Colores: A/N/R/O/V

■ ■ Colores GTM: A/N/R

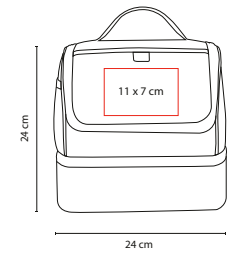

A



O



N



V

Interior plastificado. Bolsa principal y frontal.
Bolsa lateral de malla. Doble compartimento con cierre.



A



R

Interior plastificado impermeable. Bolsa frontal.
Asas laterales y correa ajustable.





G

toSSH®

■ **SIN 255**

LONCHERA JOKUL

Material: Poliéster
 Medida: 23 x 15 x 15 cm
 Área de Impresión: 11 x 7 cm
 Técnica de Impresión: Serigrafía
 Colores: A/G/R

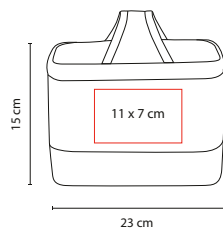

A



R

Interior plastificado.



■ **SIN 061**

HIELERA KIEL

Material: Poliéster
 Medida: 32 x 31 x 16.5 cm
 Área de Impresión: 25 x 9.5 cm
 Técnica de Impresión: Bordado / Serigrafía
 Colores: Azul
 Colores GTM: Azul

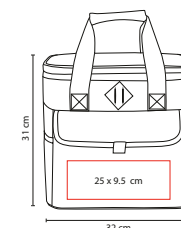

Interior plastificado impermeable. Bolsa frontal. 2 bolsas laterales de red.



A

tossh

■ **SIN 123**

LONCHERA PRESTON

Material: Poliéster
 Medida: 28 x 19 x 15.5 cm
 Área de Impresión: 15 x 9 cm
 Técnica de Impresión: Serigrafía
 Colores: A/N/O/R/V

■ ■ Colores GTM: A/R/V

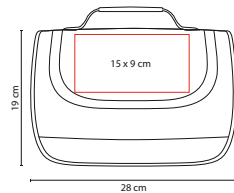

tossh

■ **SIN 225**

LONCHERA TIMOR

Material: Poliéster
 Medida: 28.5 x 25 x 17.5 cm
 Área de Impresión: 16 x 8 cm
 Técnica de Impresión: Bordado / Serigrafía
 Colores: Negro

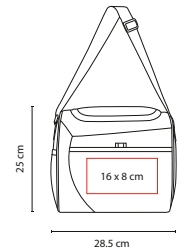

Interior plastificado.



Bolsa principal y frontal. 1 bolsa lateral de malla. Interior metalizado.





G

■ SIN 064

HIELERA JENA

Material: Poliéster
 Medida: 26.5 x 32 x 20 cm
 Área de Impresión: 10 x 10 cm
 Técnica de Impresión: Bordado / Serigrafía
 Colores: A/G/R

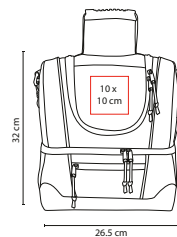

A



R

Interior plastificado impermeable. Bolsa principal y frontal.
 Bolsa lateral de red. Red interna para separar.



A

■ SIN 171

HIELERA VENOSTE

Material: Poliéster
 Medida: 20 X 24.5 cm
 Área de Impresión: 15 x 7 cm
 Técnica de Impresión: Bordado / Serigrafía
 Colores: A/R

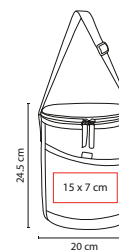

R

Interior plastificado impermeable. Bolsa frontal.



■ SIN 089

HIELERA CADENCE

Material: Poliéster / Polipropileno

Medida: 40 x 26.5 x 30 cm

Área de Impresión: 19 x 17 cm

Técnica de Impresión: Serigrafía

Colores: Negro

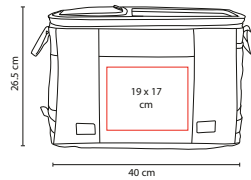

Hielera plegable. Interior plastificado impermeable. Cubierta de plástico con ventana.



■ SIN 271

MOCHILA HIELERA IGUAZU

Material: Poliéster

Medida: 25 x 37 cm

Área de Impresión: 10 x 10 cm

Técnica de Impresión: Bordado / Serigrafía

Colores: Gris

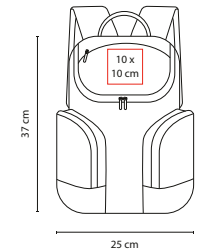

Bolsa principal y frontal. 2 bolsas laterales con cierre. Interior plastificado impermeable.





■ BBQ 002

ASADOR CON HIELERA **CAMPING**

Material: Metal / Poliéster
Medida: 29 x 16.5 cm

Área de Impresión: 12 x 12 cm

Técnica de Impresión: Bordado / Serigrafía

Colores: Negro con Gris

Colores GTM: Negro con Gris

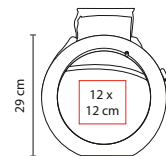
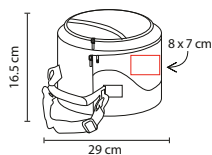

Incluye parrillas. Hielera solo en la parte superior.



■ SIN 063

HIELERA TROLLEY **OSLO**

Material: Poliéster
Medida: 37 x 39 x 33 cm

Área de Impresión: 19 x 14 cm

Técnica de Impresión: Bordado / Serigrafía

Colores: A/O/R

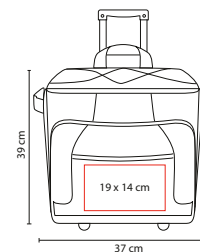

A

Interior plastificado impermeable. Bolsa frontal y 2 compartimentos con cierre. Agarraderas laterales. Mecanismo trolley.



■ KTC 060

HIELERA MILA

Material: Plástico
 Medida: 25.5 x 19 x 17 cm
 Área de Impresión: 15 x 8 cm
 Técnica de Impresión: Serigrafía
 Capacidad: 5 Litros
 Colores: Gris

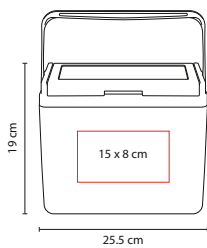

to^{ss}h

■ SIN 232

HIELERA ORGORO

Material: Poliéster
 Medida: 21 x 28.5 cm
 Área de Impresión: 8 x 3.5 cm
 Técnica de Impresión: Bordado / Serigrafía
 Colores: Negro

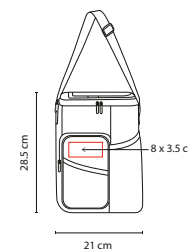

Interior plastificado impermeable. Incluye bolsa frontal con cierre y malla. Bolsa lateral de malla. Ventana superior de fácil acceso.





■ **KTC 050**

HIELERA SYN

Material: Plástico
 Medida: 35 x 33 x 25 cm
 Área de Impresión: 22 x 12 cm
 Técnica de Impresión: Serigrafía
 Capacidad: 20 Litros
 Colores: Gris

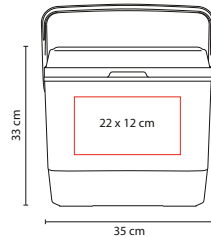

■ **KTC 040**

HIELERA SKYLER

Material: Plástico
 Medida: 50 x 39 x 31 cm
 Área de Impresión: 33 x 20 cm
 Técnica de Impresión: Serigrafía
 Capacidad: 45 Litros
 Colores: Gris

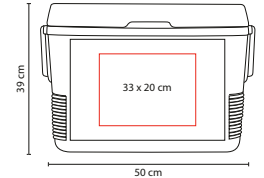



Y



■ SIN 021

BOLSA-MOCHILA PRISMA

Material: Poliéster
Medida: 38 x 46.5 cm

Área de Impresión: 25 x 35 cm
Técnica de Impresión: Serigrafía
Colores: A/B/N/O/P/R/V/Y

■ Colores GTM: A/B/N/O/P/R/V/Y

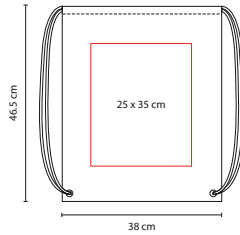

V



A



R



B



N



P



O

BOLSAS





O

SIN 130

BOLSA-MOCHILA YAIK

Material: Non Woven / Poliéster
 Medida: 36.5 x 44 cm
 Área de Impresión: 14 x 30 cm
 Técnica de Impresión: Serigrafía
 Colores: O/V

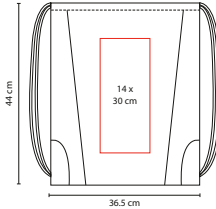

V

Con cordón sujetador.



V

SIN 054

BOLSA-MOCHILA BRETÓN

Material: Non Woven
 Medida: 34 x 44.5 cm
 Área de Impresión: 22 x 12 cm
 Técnica de Impresión: Serigrafía
 Colores: A/B/O/R/V
 Colores GTM: A/R/V

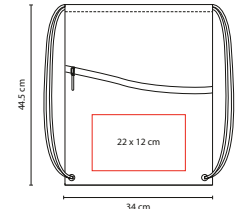

A



B



R



O

Incluye bolsa frontal y aditamento especial para audífonos. No incluye audífonos.



A

■ SIN 107

BOLSA-MOCHILA **SIMME**

Material: Non Woven
 Medida: 34 x 43 cm
 Área de Impresión: 13 x 20 cm
 Técnica de Impresión: Serigrafía
 Colores: A/B/O/R/V

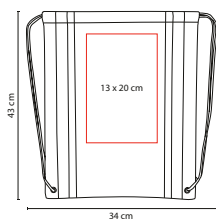

O



V



B



R

Incluye 2 tiras reflejantes.



O

■ SIN 109

BOLSA-MOCHILA **LANGETEN**

Material: Poliéster
 Medida: 36.5 x 45.5 cm
 Área de Impresión: 15 x 15 cm
 Técnica de Impresión: Serigrafía
 Colores: A/O/R/V
 ■■ Colores GTM: A/R

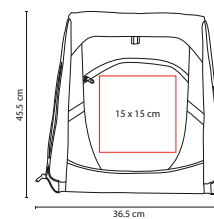

R



V



A

Incluye bolsa frontal con cierre y tiras reflejantes.





SIN 220

BOLSA-MOCHILA LORETTO

Material: 100% Algodón
 Medida: 32 x 41 cm
 Área de Impresión: 22 x 30 cm
 Técnica de Impresión: Serigrafía
 Colores: Beige

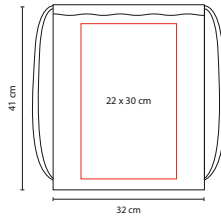

M



SIN 235

BOLSA-MOCHILA ASTORGA

Material: Non Woven
 Medida: 37 x 44.5 cm
 Área de Impresión: 26 x 33 cm
 Técnica de Impresión: Serigrafía
 Colores: A/AC/B/M/N/O/P/R/V/Y
 Colores GTM: A/B/O/P/R/V/Y

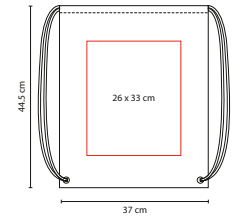



R

■ SIN 315

BOLSA-MOCHILA **ARACAR**

Material: Non Woven / Poliéster
 Medida: 32.5 x 41.5 cm
 Área de Impresión: 18 x 18 cm
 Técnica de Impresión: Serigrafía
 Colores: A/R/O/V

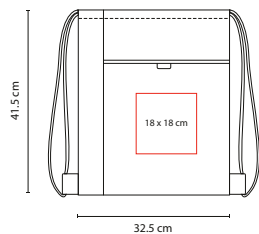

V

O

A



A

■ SIN 322

BOLSA-MOCHILA **BAZMAN**

Material: Non Woven
 Medida: 31.5 x 41 cm
 Área de Impresión: 20 x 20 cm
 Técnica de Impresión: Serigrafía
 Colores: A/N/R

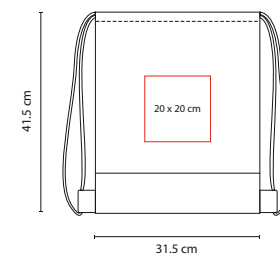

N



R





O

SIN 019

BOLSA-MOCHILA SURF

Material: Poliéster
 Medida: 36.5 x 45 cm
 Área de Impresión: 25 x 30 cm
 Técnica de Impresión: Serigrafía
 Colores: A/B/N/O/R/V
 Colores GTM: A/B/N/O/R/V

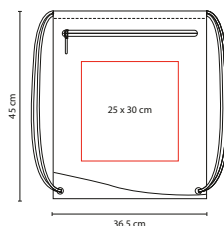

N

B

A

R

V

Incluye bolsa frontal.



N

SIN 102

BOLSA-MOCHILA SUNET

Material: Poliéster
 Medida: 35.5 x 45 cm
 Área de Impresión: 19 x 22 cm
 Técnica de Impresión: Serigrafía
 Colores: A/N/R

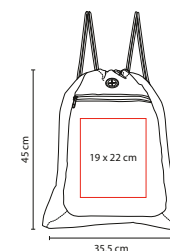

R



A

Bolsa con cierre frontal. Aditamento especial para audífonos.



A

■ SIN 933

BOLSA-MOCHILA ANSHAR

Material: Poliéster
 Medida: 36 x 44 cm
 Área de Impresión: 20 x 18 cm
 Técnica de Impresión: Serigrafía
 Colores: A/N/R
 ☑ Colores GTM: N/R

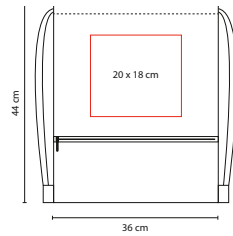

N

Bolsa con cierre frontal.



R



■ SIN 301

BOLSA-MOCHILA ZITE

Material: Poliéster
 Medida: 38 x 42.5 cm
 Área de Impresión: 20 x 12 cm
 Técnica de Impresión: Serigrafía
 Colores: Gris

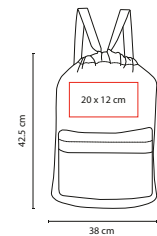

Incluye bolsa frontal con cierre.





A



SIN 078

BOLSA MARIEL

Material: Non Woven
 Medida: 18 x 28 cm
 Área de Impresión: 12 x 16 cm
 Técnica de Impresión: Serigrafía
 Colores: A/N/R/V
 Colores GTM: Negro

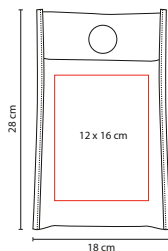

V



R



N

Bolsa para basura portátil.



BOLSA SPRING
SIN 112

Interior plastificado



ECOLÓGICA



O

SIN 111

BOLSA GERINE

Material: Poliéster
 Medida: 10.5 x 11.5 cm Cerrada /
 38.5 x 39.5 cm Abierta
 Área de Impresión: 6 x 6 cm Cerrada /
 20 x 20 cm Abierta

Técnica de Impresión: Serigrafía
 Colores: A/N/O/P/R/V

Colores GTM: A/R

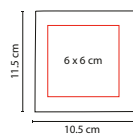
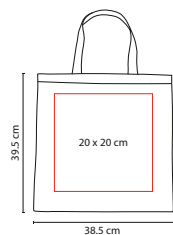

A

V

N

P

R



Bolsa mágica plegable. Incluye compartimento interno.



V

SIN 131

BOLSA CIMBOA

Material: Non Woven
 Medida: 35.5 x 45.5 cm
 Área de Impresión: 27 x 30 cm
 Técnica de Impresión: Serigrafía
 Colores: A/B/N/O/R/V/Y

Colores GTM: A/B/O/R/V

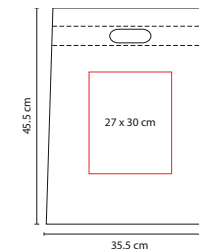

R

B

A

Y

N

O

Bolsa sellada a calor.





■ SIN 320

BOLSA LAPA

Material: Tejido de Papel Kraft
 Medida: 30 x 33 x 13.5 cm
 Área de Impresión: 20 x 20 cm
 Técnica de Impresión: Serigrafía
 Colores: Beige
 ■ Colores GTM: Beige

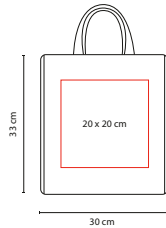

Bolsa con fuelle.



M



■ SIN 230

BOLSA ECOLÓGICA ENVIRONMENT

Material: Non Woven
 Medida: 32 x 42 x 17.5 cm
 Área de Impresión: 26 x 27 cm
 Técnica de Impresión: Serigrafía
 Colores: A/B/BE/C/M/N/O/R/V
 ■ Colores GTM: A/B/BE/C/N/O/R/V

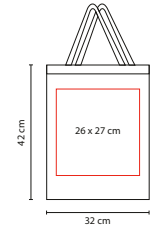

Bolsa con fuelle.



N



■ SIN 043

BOLSA TOLEDO

Material: Non Woven
 Medida: 30 x 33.7 cm
 Área de Impresión: 21 x 27 cm
 Técnica de Impresión: Serigrafía
 Colores: A/B/N/O/P/R/V/Y
 Colores GTM: A/B/N/O/R/V/Y

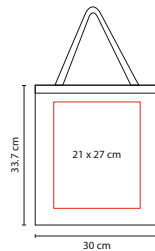

Bolsa sin fuelle.



R

■ SIN 340

BOLSA TASU

Material: Non Woven
 Medida: 38 x 32 x 11.3 cm
 Área de Impresión: 26 x 16 cm
 Técnica de Impresión: Serigrafía
 Colores: A/O/R/V

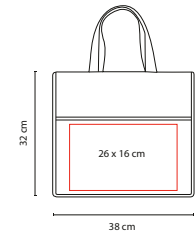

Bolsa con fuelle. Bolsa frontal.





R



SIN 238

BOLSA TARAFÁ

Material: Non Woven
 Medida: 18 x 10 cm Cerrada / 40 x 45 cm Abierta
 Área de Impresión: 12 x 10 cm Abierta
 Técnica de Impresión: Serigrafía
 Colores: A/N/R

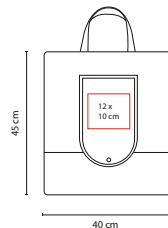

A

N

Bolsa plegable con broche de plástico.



V



SIN 041

BOLSA SHOPPER

Material: Non Woven
 Medida: 39 x 44 x 9.5 cm
 Área de Impresión: 30 x 20 cm
 Técnica de Impresión: Serigrafía
 Colores: A/N/O/R/V
 Colores GTM: A/N/O/R/V

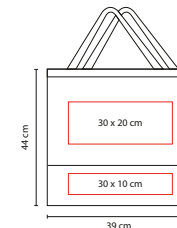

A



R



N



O

Bolsa con fuelle.



A



■ SIN 175

BOLSA MORAB

Material: Non Woven
 Medida: 35 x 37 x 16 cm
 Área de Impresión: 26 x 29 cm
 Técnica de Impresión: Serigrafía
 Colores: A/B/N/R

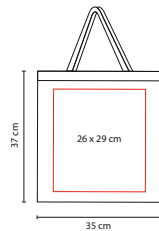

N



B



R

Bolsa plegable con botón.



P



■ SIN 210

BOLSA COTTON SLIM

Material: 100% Algodón
 Medida: 35 x 41.5 cm
 Área de Impresión: 26 x 30 cm
 Técnica de Impresión: Serigrafía
 Colores: A/BE/N/O/P/R/V

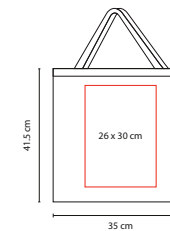

N



BE



R



A



V



O

Bolsa sin fuelle.





SIN 048

BOLSA AVERY

Material: Non Woven Laminado
 Medida: 30.4 x 38 x 15.5 cm
 Área de Impresión: 20 x 24 cm
 Técnica de Impresión: Serigrafía
 Colores: A/B/N/O/R/V
 Colores GTM: A/O/R/V

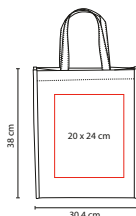

Bolsa con fuelle.



SIN 022

BOLSA RIOJA

Material: Non Woven
 Medida: 50 x 39.5 cm
 Área de Impresión: 35 x 28 cm
 Técnica de Impresión: Serigrafía
 Colores: A/B/N/O/R

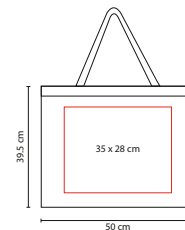

Bolsa sin fuelle.



P

■ SIN 147

BOLSA BAGGARA

Material: Non Woven Laminado
 Medida: 24.5 x 37.5 x 10 cm
 Área de Impresión: 16 x 20 cm
 Técnica de Impresión: Serigrafía
 Colores: A/O/P/R/V/Y
 Colores GTM: A/O/R/V

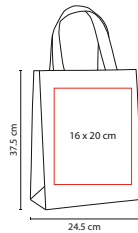

Bolsa con fuelle sellada a calor.



O



V



R



Y



A



M

■ SIN 075

BOLSA BELAYA

Material: Non Woven Laminado
 Medida: 39 x 34 x 13.5 cm
 Área de Impresión: 27 x 21 cm
 Técnica de Impresión: Serigrafía
 Colores: A/M/O/R/V

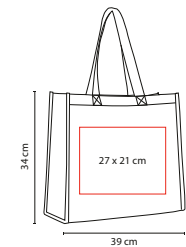

Bolsa con fuelle.



O



R



V



A





G

■ SIN 073

BOLSA ARIANNA

Material: Non Woven Laminado
 Medida: 48 x 35 x 15 cm
 Área de Impresión: 17 x 6 cm
 Técnica de Impresión: Serigrafía
 Colores: A/G/N/R

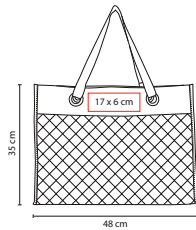

Bolsa con fuelle.



R

■ SIN 086

BOLSA SPARKLY

Material: Non Woven Laminado
 Medida: 40 x 30 x 10 cm
 Área de Impresión: 30 x 20 cm
 Técnica de Impresión: Serigrafía
 Colores: A/N/O/P/R

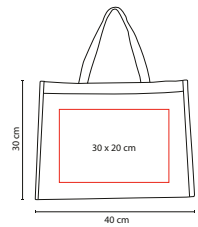

Bolsa con fuelle.



R

■ SIN 047

BOLSA CARNAVAL

Material: Non Woven Metalizado
 Medida: 40 x 45 x 10 cm
 Área de Impresión: 30 x 35 cm
 Técnica de Impresión: Serigrafía
 Colores: A/D/R/S/V

■ ■ Colores GTM: A/D/R/S/V

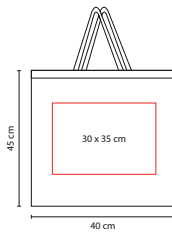

V



D



A



S

Bolsa con fuelle.



O

■ SIN 055

BOLSA LENA

Material: 100% Algodón
 Medida: 48.5 x 32 x 10 cm
 Área de Impresión: 10 x 13 cm
 Técnica de Impresión: Bordado
 Colores: A/O/R/V

■ ■ Colores GTM: A/R/V

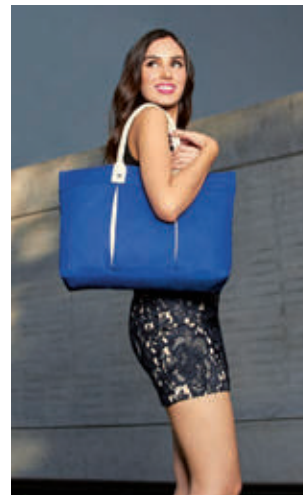
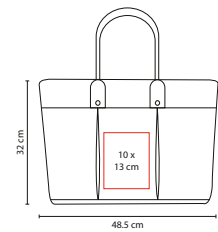

R



V



A





A



SIN 062

BOLSA TORBA

Material: Yute
 Medida: 46 x 32 x 17 cm
 Área de Impresión: 40 x 15 cm
 Técnica de Impresión: Serigrafía
 Colores: A/N/O/R/V

Colores GTM: A/N/R

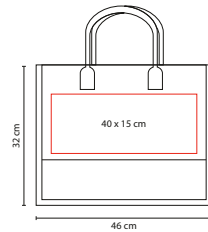

O



V



N



R

Bolsa con fuelle. Interior plastificado.



SIN 112

BOLSA SPRING

Material: Yute
 Medida: 30 x 30 x 19 cm
 Área de Impresión: 20 x 20 cm
 Técnica de Impresión: Bordado / Serigrafía
 Colores: Beige

Colores GTM: Beige

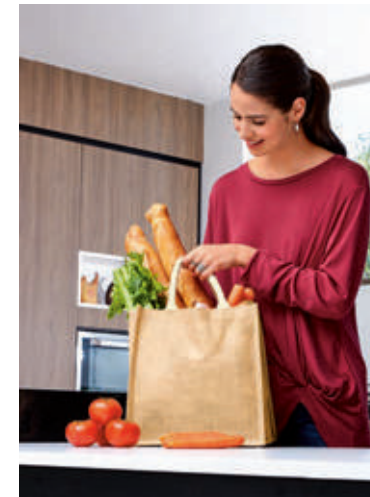
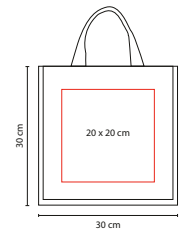

Interior plastificado.



■ SIN 114

BOLSA WINTER

Material: Yute
 Medida: 45.5 x 34 x 14 cm
 Área de Impresión: 34 x 21 cm
 Técnica de Impresión: Bordado / Serigrafía
 Colores: Beige
 ■ ■ Colores GTM: Beige

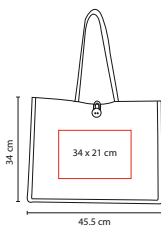

Interior plastificado. Botón de madera al frente.



R



■ SIN 138

BOLSA MEZZOLA

Material: Yute / Algodón
 Medida: 37.5 x 41 cm
 Área de Impresión: 20 x 18 cm
 Técnica de Impresión: Serigrafía
 Colores: A/N/O/R/V
 ■ ■ Colores GTM: A/O/R/V

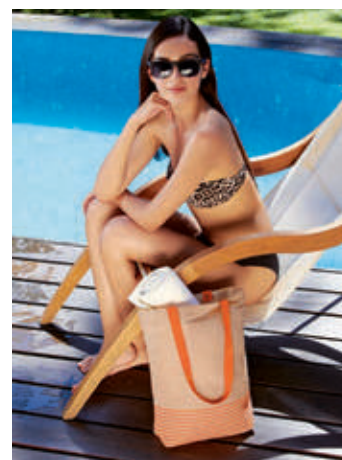
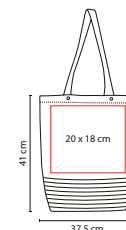



V



■ SIN 087

BOLSA ALMEZ

Material: Yute

Medida: 35 x 32.5 x 20 cm

Área de Impresión: 18 x 18 cm

Técnica de Impresión: Serigrafía

Colores: A/N/O/R/V

■ ■ Colores GTM: A/O/R/V

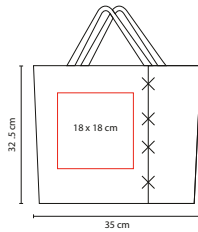

R



N



A



O

Bolsa con fuelle.



■ SIN 113

BOLSA FALL

Material: Yute

Medida: 52 x 35.5 x 13 cm

Área de Impresión: 32 x 23 cm

Técnica de Impresión: Bordado / Serigrafía

Colores: Beige

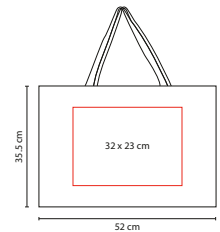

Bolsa con fuelle.

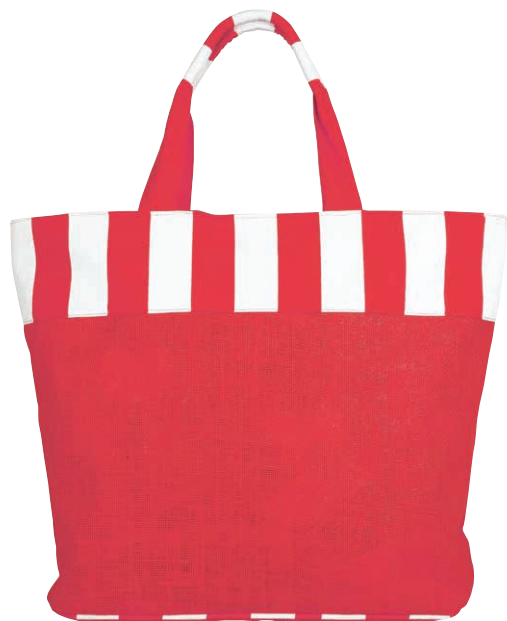

R

■ SIN 065

BOLSA MALLORQUÍN

Material: Yute
 Medida: 51 x 38 x 14.5 cm
 Área de Impresión: 30 x 20 cm
 Técnica de Impresión: Serigrafía
 Colores: A/O/P/R/V

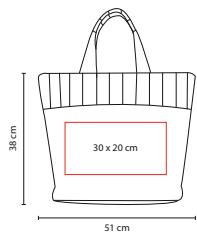

V



O



A



P



N

■ SIN 141

BOLSA CART BAG

Material: Poliéster
 Medida: 31 x 52.5 x 13 cm
 Área de Impresión: 22 x 18 cm
 Técnica de Impresión: Bordado / Serigrafía
 Colores: A/N/R

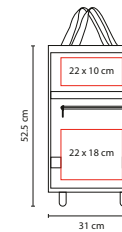

A

R

Incluye bolsa frontal y principal.





MOCHILAS



R

SIN 038

MOCHILA EUROPE

Material: Poliéster
 Medida: 38 x 42 x 13 cm
 Área de Impresión: 12 x 12 cm
 Técnica de Impresión: Bordado / Serigrafía
 Colores: A/M/O/R/V/Y
 Colores GTM: A/O/R/V/Y

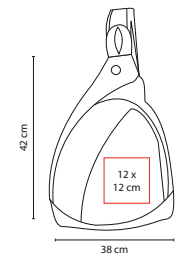

Aditamento especial para audífonos.



V

■ SIN 060

MOCHILA ANTARA

Material: Poliéster
 Medida: 38 x 42 x 18 cm
 Área de Impresión: 10 x 14 cm
 Técnica de Impresión: Bordado / Serigrafía
 Colores: A/O/R/S/V
 ☐ Colores GTM: A/O/R/S/V

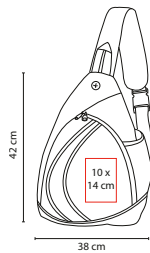

Aditamento especial para audífonos. Bolsa para celular.



A

■ SIN 922

MOCHILA DOBRICH

Material: Poliéster
 Medida: 33 x 40 x 8 cm
 Área de Impresión: 10 x 5.5 cm
 Técnica de Impresión: Serigrafía
 Colores: A/N/O/R/V
 ☐ Colores GTM: A/R/V

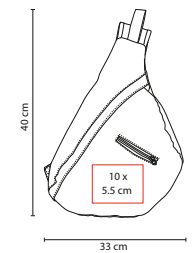

Bolsa principal y frontal.





V

■ **SIN 098**

MOCHILA AUNAT

Material: Poliéster
Medida: 28 x 39 cm

Área de Impresión: 11 x 11 cm

Técnica de Impresión: Bordado / Serigrafía
Colores: A/N/O/R/V

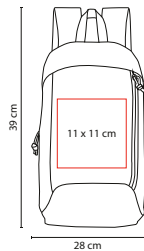

N



R



A



O

Bolsa principal y frontal.



R

■ **SIN 402**

MOCHILA PARIS

Material: Non Woven
Medida: 29 x 40 x 10 cm

Área de Impresión: 12 x 8 cm

Técnica de Impresión: Serigrafía
Colores: A/N/O/R

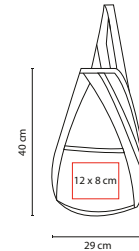

A



N



O

Bolsa principal y frontal.



A

■ SIN 079

MOCHILA ALSHAIN

Material: Poliéster
 Medida: 23 x 42 x 11 cm
 Área de Impresión: 13 x 13 cm
 Técnica de Impresión: Bordado / Serigrafía
 Colores: A/O/R/V

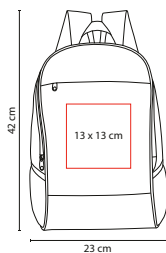

V



R



O

Bolsa principal y frontal. Bolsas laterales de malla.



N

■ SIN 197

MOCHILA BURUM

Material: Poliéster
 Medida: 26.5 x 42 x 10 cm
 Área de Impresión: 12 x 12 cm
 Técnica de Impresión: Bordado / Serigrafía
 Colores: A/N/R

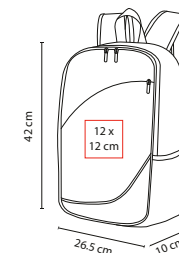

R



A

Bolsa principal y frontal con cierre. Bolsa frontal con organizador.
 2 Bolsas laterales de malla.





A



R



■ SIN 099

MOCHILA LORZE

Material: Poliéster

Medida: 29 x 40 x 10.5 cm

Área de Impresión: 15 x 15 cm

Técnica de Impresión: Bordado / Serigrafía

Colores: A/O/R/V

■ Colores GTM: A/O/R/V

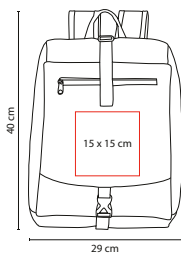

■ SIN 148

MOCHILA KEIT

Material: Poliéster

Medida: 31 x 37 x 13.5 cm

Área de Impresión: 9 x 13 cm

Técnica de Impresión: Bordado / Serigrafía

Colores: A/O/R/V

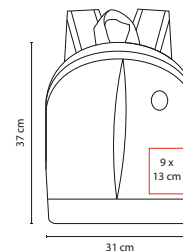

V



O



R



O



V



A

Bolsa principal.
Parte frontal incluye estuche adherible con broches de plástico para desprender.

Aditamento especial para audífonos.
Bolsa principal con un compartimento interior.



R

■ SIN 120

MOCHILA MAURITANIA

Material: Poliéster
 Medida: 33 x 39 x 13 cm
 Área de Impresión: 10 x 16 cm
 Técnica de Impresión: Bordado / Serigrafía
 Colores: A/N/R
 Colores GTM: A/N/R

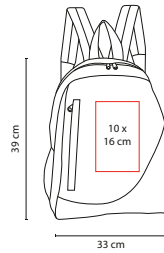

A



N

Bolsa frontal y bolsa lateral de red.



O

■ SIN 092

MOCHILA SPRINGBOK

Material: Poliéster
 Medida: 29 x 38 x 13 cm
 Área de Impresión: 13 x 22 cm
 Técnica de Impresión: Bordado / Serigrafía
 Colores: A/O/P/R/V
 Colores GTM: A/P/R/V

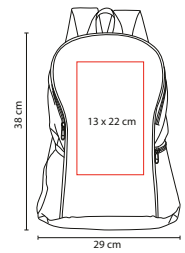

V



A



R



P

Bolsa principal. Bolsas laterales, una con cierre y una con red.





P

■ SIN 149

MOCHILA NEVERI

Material: Poliéster

Medida: 31 x 40 x 15 cm

Área de Impresión: 10 x 17 cm

Técnica de Impresión: Bordado / Serigrafía

Colores: A/O/P/R/V/Y

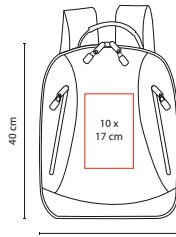

31 cm



O

V

R

Y

A

Bolsa frontal con doble cierre. Bolsa principal con organizador con 4 compartimentos.



R

■ SIN 074

MOCHILA CITARUM

Material: Poliéster

Medida: 29 x 37 x 15 cm

Área de Impresión: 10 x 14 cm

Técnica de Impresión: Bordado / Serigrafía

Colores: A/R

■ Colores GTM: A/R

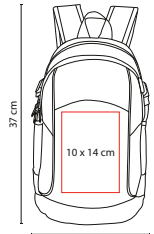

29 cm



A

Bolsa principal y frontal. Bolsa principal con espacio para tablet. Bolsas laterales de malla.



A

■ SIN 026

MOCHILA ACCENT

Material: Poliéster
 Medida: 33 x 40 x 10 cm
 Área de Impresión: 13 x 16 cm
 Técnica de Impresión: Bordado / Serigrafía
 Colores: A/N/R
 ■ Colores GTM: A/N/R

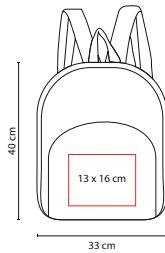

R



N

Bolsa frontal y principal.



R

■ SIN 921

MOCHILA BLISS

Material: Poliéster
 Medida: 32 x 42 x 12 cm
 Área de Impresión: 14 x 14 cm
 Técnica de Impresión: Bordado
 Colores: A/O/R/V

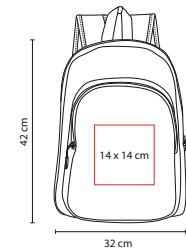

V



A



O

Mochila de malla. Bolsa principal y frontal.





O

■ SIN 490

MOCHILA CAURA

Material: Poliéster
 Medida: 31 x 41 x 11 cm
 Área de Impresión: 12 x 18 cm
 Técnica de Impresión: Bordado / Serigrafía
 Colores: A/N/O/P/R/V

■ Colores GTM: A/N/R

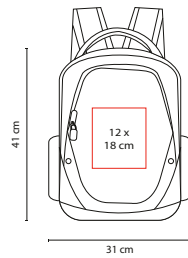

A

■ SIN 159

MOCHILA CAMBRIDGE

Material: Poliéster
 Medida: 35 x 43 x 13 cm
 Área de Impresión: 10 x 13 cm
 Técnica de Impresión: Bordado / Serigrafía
 Colores: A/N/R

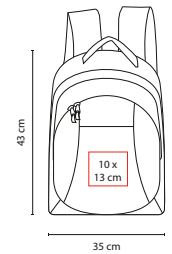

P



R



A



N



V



R



N

Bolsa frontal intermedia y principal. Dos bolsas laterales de red.

Bolsa frontal con compartimento para 3 bolígrafos, celular y documentos. Espacio para laptop.

tossh®

MOCHILA MASAI
SIN 116

Bolsa principal. Espacio para laptop y tablet.
Bolsa frontal con organizador, bolsa con cierre y red.
Cuenta con un compartimento oculto en la parte posterior.





N

toSSH

■ SIN 010

MOCHILA VICTORY

Material: Poliéster
Medida: 32 x 46 x 13.5 cm

Área de Impresión: 9 x 6 cm

Técnica de Impresión: Bordado / Serigrafía

Colores: A/N/O/R/S

■ ■ Colores GTM: A/R

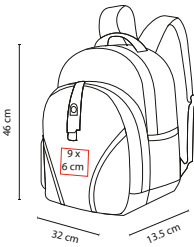

A

O

S

R

Aditamento especial para audífonos. Compartimento lateral. Tirantes y espalda acojinados. No incluye cilindro.



G

■ SIN 907

MOCHILA MÓNACO

Material: Poliéster

Medida: 30.5 x 47.5 x 9.5 cm

Área de Impresión: 13 x 17 cm

Técnica de Impresión: Bordado / Serigrafía

Colores: A/G/N

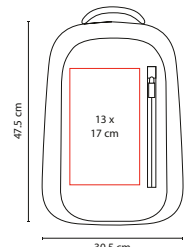

N

A

Incluye compartimento para laptop y tablet. Incluye organizador de documentos. Bolsa principal y frontal. Respaldo y tirantes acojinados.



O

to^{ss}h®

SIN 903

MOCHILA ADVENTURE

Material: Poliéster
 Medida: 33 x 49 x 18.5 cm
 Área de Impresión: 13 x 15 cm
 Técnica de Impresión: Bordado / Serigrafía
 Colores: A/O/R/V

Colores GTM: A/O/R/V

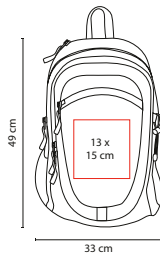

V

SIN 915

MOCHILA BITONO NOVA

Material: Poliéster
 Medida: 29 x 44 x 15 cm
 Área de Impresión: 12 x 23 cm
 Técnica de Impresión: Bordado / Serigrafía
 Colores: A/O/R/V

Colores GTM: A/R/V

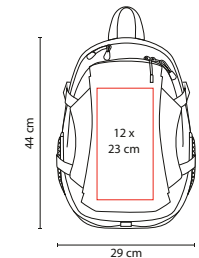

R

V

A

Espacio para laptop. Tres bolsas frontales con compartimentos para celular y documentos.
 Bolsa lateral de malla. Respaldo y tirantes acojinados.



O

R

A

Bolsa principal y frontal. Bolsas laterales de malla. Espacio para laptop.





G

SIN 096

MOCHILA WALLY

Material: Poliéster
 Medida: 30 x 43 x 11 cm
 Área de Impresión: 20 x 16 cm
 Técnica de Impresión: Bordado / Serigrafía
 Colores: A/G/R

Colores GTM: A/G

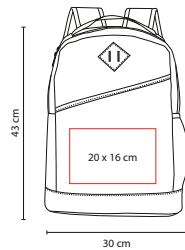

Bolsa principal y bolsa lateral con malla. Espacio para laptop.



R



A



R

SIN 965

MOCHILA HAISLA

Material: Poliéster
 Medida: 33 x 42 x 8.5 cm
 Área de Impresión: 13 x 13 cm
 Técnica de Impresión: Bordado / Serigrafía
 Colores: A/G/O/R

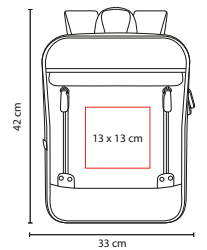

O



G



A

Bolsa con cierres frontales y compartimento para documentos.
 Bolsa principal con espacio para laptop. Tirantes y espalda acojinados.



G

■ SIN 971

MOCHILA SKADI

Material: Poliéster
 Medida: 31 x 42 x 8.5 cm
 Área de Impresión: 9 x 9 cm
 Técnica de Impresión: Serigrafía
 Colores: A/G/O/R

■ Colores GTM: A/R

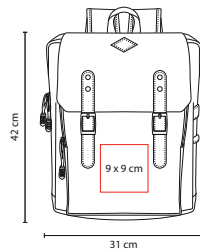

R



O



A

Bolsa frontal. Dos bolsas laterales. Compartimento para laptop.



to^{ss}h

■ SIN 189

MOCHILA IPORA

Material: Poliéster
 Medida: 31 x 45 x 9.5 cm
 Área de Impresión: 15 x 10 cm
 Técnica de Impresión: Bordado / Serigrafía
 Colores: Gris

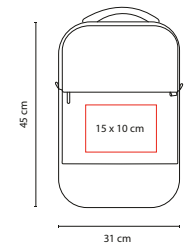

Bolsa principal y frontal. Compartimento interno para laptop.
 Aditamento especial trasero para poner en trolley. Tirantes y espalda acolchonados.





■ SIN 108

MOCHILA TIKAL

Material: Algodón / Canvas

Medida: 32 x 39 x 14 cm

Área de Impresión: 16 x 15 cm

Técnica de Impresión: Bordado / Serigrafía

Colores: Verde

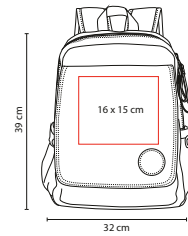

Bolsa principal y frontal. Dos bolsas laterales. Espacio para laptop.



A

tossh®

■ SIN 909

MOCHILA CISSE

Material: Poliéster

Medida: 32 x 43 x 13 cm

Área de Impresión: 22 x 23 cm

Técnica de Impresión: Bordado / Serigrafía

Colores: A/G

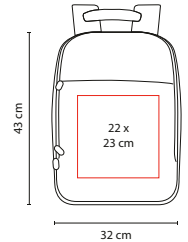

G

Bolsa principal y frontal. Incluye compartimento para laptop.



A

tossh

■ **SIN 116**

MOCHILA MASAI

Material: Poliéster
 Medida: 29 x 45 x 14 cm
 Área de Impresión: 16 x 17 cm
 Técnica de Impresión: Bordado / Serigrafía
 Colores: A/R

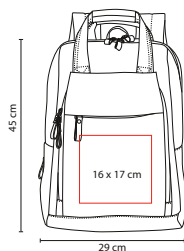

R

Bolsa principal. Espacio para laptop y tablet. Bolsa frontal con organizador, bolsa con cierre y red. Cuenta con un compartimento oculto en la parte posterior.



tossh

■ **SIN 177**

MOCHILA REUS

Material: Poliéster
 Medida: 30.5 x 37 x 8 cm
 Área de Impresión: 16 x 18 cm
 Técnica de Impresión: Bordado / Serigrafía
 Colores: Café

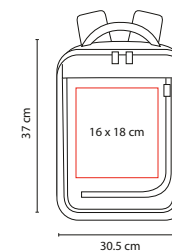

Bolsa principal con compartimento para laptop. Bolsa frontal con organizador de documentos. Respaldo y tirantes acojinados.





tossh

■ SIN 202

MOCHILA BARANSKY

Material: Canvas
 Medida: 30 x 40 x 11.5 cm
 Área de Impresión: 12 x 15 cm
 Técnica de Impresión: Bordado / Serigrafía
 Colores: Verde

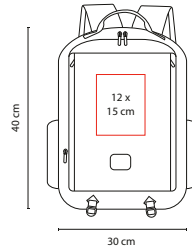

Bolsa principal y 2 bolsos frontales. 2 Bolsas laterales. Bolsa principal con compartimento para laptop y bolsa interna con cierre.



tossh

■ SIN 115

MOCHILA PORTAFOLIO DARO

Material: Poliéster
 Medida: 27.5 x 39.5 x 10 cm
 Área de Impresión: 18 x 22 cm
 Técnica de Impresión: Bordado / Serigrafía
 Colores: Café

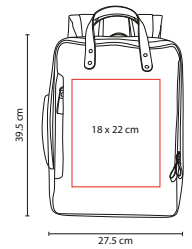

Mochila portafolio. Bolsa principal y frontal. Espacio para laptop y tablet. Bolsa interna con organizador. Bolsa interna con cierre y red. Bolsa trasera con cierre.



tossh[®]



Swissdigital[®]



■ SIN 101

MOCHILA KLEINE

Material: Poliéster

Medida: 30 x 45 x 16 cm

Área de Impresión: 9 x 7 cm

Técnica de Impresión: Bordado / Serigrafía

Colores: Negro

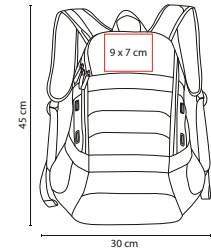

Mochila Bluetooth. Bolsa frontal. Bolsa principal con compartimento para laptop. Tirantes y respaldo acolijnados, tirante con aditamento especial para colgar lentes y bolígrafo. Tirante con compartimento con salida USB (se requiere conectar a una batería auxiliar) para cargar smartphone y dispositivo bluetooth de reproducción de audio y llamada. Salida USB y de audio de 3.5 mm. Batería auxiliar no incluida.

TEXTILES



MOCHILAS CASUALES

3.5mm PROMOTIONAL OPTION

320



to'ssh^{by}

■ SIN 083

MOCHILA SUHRE

Material: Poliéster
Medida: 30 x 48 x 12 cm

Área de Impresión: 15 x 10 cm

Técnica de Impresión: Bordado / Serigrafía

Colores: Azul



Swissdigital[®]

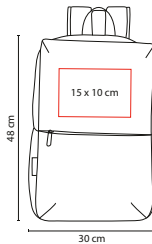

2 Bolsas frontales. Bolsa frontal con compartimento interno y carabina para llaves.

Incluye compartimento con sistema anti robo RFID. Bolsa principal con espacio para laptop, tablet y organizador de documentos. Tirante con salida USB (se requiere conectar a batería portátil) para cargar smartphone. Bolsas laterales con elástico. Batería portátil no incluida.



C

■ SIN 070

MOCHILA MONTANA

Material: Microfibra
Medida: 33 x 41 x 11 cm

Área de Impresión: 13 x 13 cm

Técnica de Impresión: Bordado / Serigrafía

Colores: A/C/R

■ Colores GTM: Café

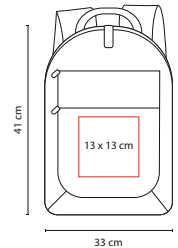

Incluye espacio frontal para laptop y con compartimento interno. Bolsa intermedia con organizador. Incluye 4 compartimentos.



tossh

■ **SIN 142**

MOCHILA PORTA LAPTOP CORVUS

Material: Poliéster
 Medida: 34 x 47 x 15 cm
 Área de Impresión: 11 x 19 cm
 Técnica de Impresión: Bordado / Serigrafía
 Colores: Plata
 Colores GTM: Plata

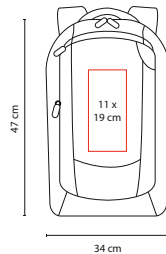

Bolsa frontal con organizador con 6 compartimentos, bolsa principal con espacio para laptop, tablet, bolígrafos y documentos. Respaldo y tirantes acojinados. Respaldo con cierre y porta celular interno.



tossh

■ **SIN 084**

MOCHILA YANGZY

Material: Poliéster / Poliuretano
 Medida: 35 x 43 x 7 cm
 Área de Impresión: 4.5 x 4 cm Resina /
 12 x 13 cm Frente
 Técnica de Impresión: Goteado en Resina /
 Serigrafía
 Colores: Negro

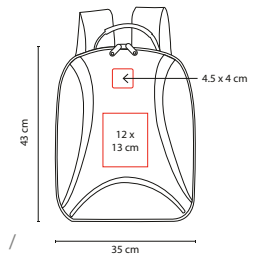

Espacio para laptop y 3 compartimentos.





■ **SIN 195**

MOCHILA **KONGUR**

Material: Poliéster
 Medida: 31 x 42 x 9 cm
 Área de Impresión: 14 x 14 cm
 Técnica de Impresión: Bordado / Serigrafía
 Colores: Negro

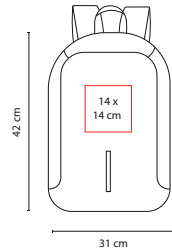

Mochila antirrobo. Bolsa principal con cierre oculto. Incluye compartimento para laptop y dos bolsas internas. Línea reflejante al frente. Tirantes y parte trasera acolchonados.



toSSH

■ **SIN 069**

MOCHILA PORTAFOLIO **KRONBERG**

Material: Poliéster
 Medida: 32 x 40 x 8 cm
 Área de Impresión: 16 x 7 cm
 Técnica de Impresión: Bordado / Serigrafía
 Colores: Negro

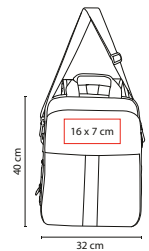

2 Bolsas frontales. Bolsa frontal con cierre en forro para facilitar bordado.
 Bolsa principal con espacio para laptop y organizador de cables y documentos removible.
 Parte trasera con cierre para esconder tirantes removibles. Incluye asa para colgar en hombros.



tossh

■ **SIN 902**

MOCHILA METROPOLITAN

Material: Poliéster
 Medida: 34 x 49 x 17 cm
 Área de Impresión: 12 x 14 cm
 Técnica de Impresión: Serigrafía
 Colores: Negro
 Colores GTM: Negro

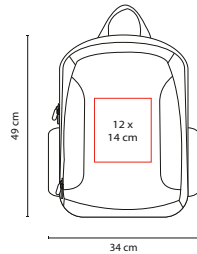

FUNDA IMPERMEABLE

Bolsa principal con espacio para laptop. Bolsa central para tablet.
 Bolsa frontal con compartimentos para celular, bolígrafos y documentos. Bolsas laterales con cierre.
 Respaldo con cierre y porta celular interno. Respaldo y tirantes acojinados.
 Compartimento inferior con funda impermeable para la mochila. Incluye porta llaves.



tossh

■ **SIN 143**

MOCHILA TROLLEY POLUX

Material: Poliéster
 Medida: 33 x 50 x 20 cm
 Área de Impresión: 13 x 12 cm
 Técnica de Impresión: Bordado / Serigrafía
 Colores: Negro con Gris
 Colores GTM: Negro con Gris

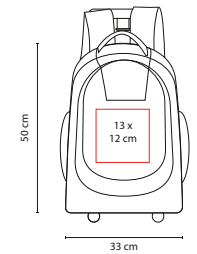

Bolsa frontal con compartimento, aditamento especial para audífonos, compartimento para resguardo de tirantes, dos bolsas laterales de red y espacio para laptop.





toss

■ **SIN 145**

MOCHILA TROLLEY SIRIO

Material: Poliéster
 Medida: 36 x 52 x 25 cm
 Área de Impresión: 13 x 6 cm
 Técnica de Impresión: Serigrafía
 Colores: Negro

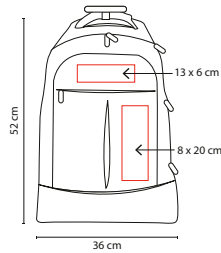

toss

■ **SIN 076**

MOCHILA TROLLEY KRONBERG

Material: Poliéster
 Medida: 36 x 47 x 17 cm
 Área de Impresión: 10 x 4 cm
 Técnica de Impresión: Bordado / Serigrafía
 Colores: Negro

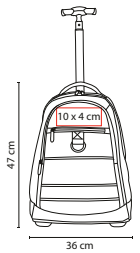

Dos bolsas frontales con organizador, 7 compartimentos, espacio para laptop, compartimento para resguardo de tirantes y un compartimento inferior para zapatos.



2 Bolsas frontales. Porta llaves frontal. Bolsa principal con espacio para laptop. Parte trasera con cierre para esconder tirantes removibles.



0

■ SIN 136

PORTA LAPTOP DANUVIO

Material: Poliéster

Medida: 37 x 30 x 8.5 cm

Área de Impresión: 22 x 18 cm

Técnica de Impresión: Bordado / Serigrafía

Colores: A/N/O/R

■ Colores GTM: A/N/O/R

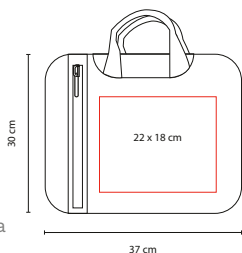

N

A

R

Tres compartimentos. Espacio para laptop de 15".



PORTAFOLIOS

TEXTILES



PORTAFOLIOS





V

LAP 005

PORTA LAPTOP LOANDA

Material: Neopreno
 Medida: 36 x 27 x 3 cm
 Área de Impresión: 28 x 10 cm
 Técnica de Impresión: Serigrafía /
 Goteado en Resina
 Colores: A/O/P/R/V

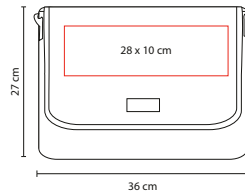

R



O



A



P

Porta laptop de 16" con correa. Broche velcro.



R

SIN 135

PORTAFOLIO CÁDIZ

Material: Poliéster
 Medida: 39 x 31 x 11 cm
 Área de Impresión: 21 x 10 cm
 Técnica de Impresión: Bordado / Serigrafía
 Colores: A/N/R

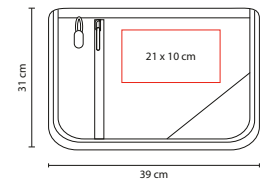

N



A

Cuatro compartimentos, dos bolsas laterales de red con broche velcro.



R

■ SIN 970

PORTA LAPTOP **BARLETTA**

Material: Poliéster
 Medida: 40 x 30 x 4 cm
 Área de Impresión: 29 x 13 cm
 Técnica de Impresión: Bordado / Serigrafía
 Colores: A/R

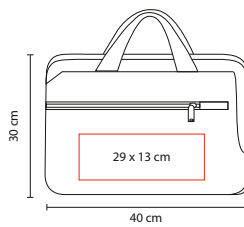

A

Espacio para laptop hasta 17".
 Bolsa principal y frontal.



toSSH ■ SIN 940

PORTAFOLIO **OWEN**

Material: Poliéster
 Medida: 42 x 30 x 10 cm
 Área de Impresión: 16 x 5 cm
 Técnica de Impresión: Serigrafía
 Colores: Gris

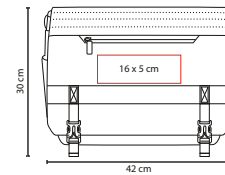

Cierre frontal. Espacio para laptop de 15", tarjetas y documentos. Bolsa lateral. Aditamento especial trasero para poner en trolley.



A

■ SIN 494

PORTAFOLIO **GRIGGS**

Material: Poliéster
 Medida: 36 x 33 x 10 cm
 Área de Impresión: 17 x 17 cm
 Técnica de Impresión: Bordado / Serigrafía
 Colores: A/N/R

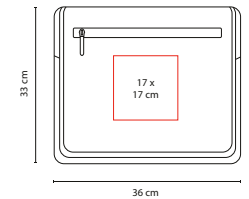

N



R

Bolsa principal con cierre y broche velcro.
 Bolsa frontal con cierre. Incluye organizador,
 bolsa pequeña con broche velcro, porta bolígrafos y porta documentos.
 Incluye correa para colgar en hombros.





■ **SIN 530**

PORTA LAPTOP **BADET**

Material: Poliéster
 Medida: 35 x 30 x 2 cm
 Área de Impresión: 17 x 14 cm
 Técnica de Impresión: Bordado / Serigrafía
 Colores: Gris

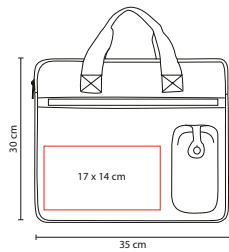

Portafolio con compartimento para laptop de 13", cierre frontal y aditamento especial de silicón para celular.



■ **SIN 039**

PORTAFOLIO **SOLUTIONS**

Material: Poliéster
 Medida: 38 x 33 x 6 cm
 Área de Impresión: 28 x 20 cm
 Técnica de Impresión: Serigrafía
 Colores: Negro
 Colores GTM: Negro

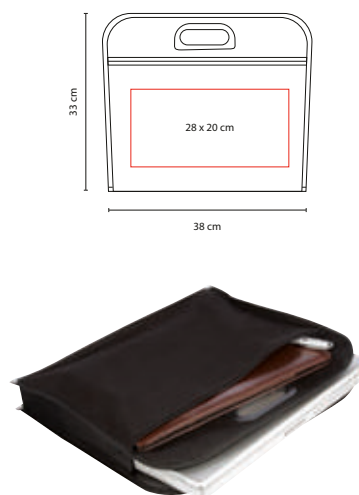

Espacio para documentos. Cierre frontal.



toSSH ■ **SIN 720**

PORTAFOLIO **MELBOURNE**

Material: Poliéster
 Medida: 38 x 32 x 9 cm
 Área de Impresión: 18 x 13 cm
 Técnica de Impresión: Bordado / Serigrafía
 Colores: Negro con Plata

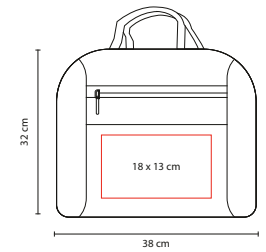

Espacio para laptop de 15" y bolsa frontal.



R

toSSH®

■ SIN 308

PORTAFOLIO FLORENCIA

Material: Microfibra
 Medida: 40 x 31 x 5 cm
 Área de Impresión: 25 x 18 cm
 Técnica de Impresión: Bordado / Serigrafía
 Colores: A/C/R

■ Colores GTM: Café

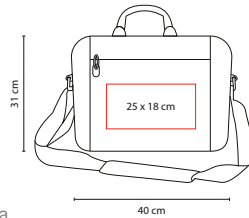

■ SIN 488

PORTAFOLIO AZAT

Material: Poliéster
 Medida: 41 x 30 x 6.5 cm
 Área de Impresión: 17 x 10 cm
 Técnica de Impresión: Bordado / Serigrafía
 Colores: Gris

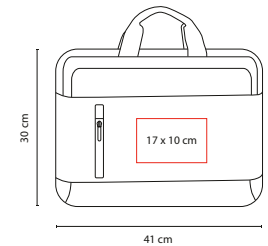

A

C

Bolsa frontal con compartimentos para bolígrafos, celular y tarjetas.
 Bolsa principal con 3 compartimentos para accesorios y un espacio acojinado para laptop de 14".
 Con asa metálica.



Bolsa principal con espacio para laptop de 15", organizador y bolsa interna con cierre.
 2 bolsas con cierre frontales.
 Incluye correa para colgar en hombros y aditamento especial trasero para poner en trolley.





■ **SIN 040**

PORTAFOLIO **BELEG**

Material: Poliéster
 Medida: 40 x 30 x 6 cm
 Área de Impresión: 29 x 19 cm
 Técnica de Impresión: Bordado /
 Serigrafía
 Colores: Negro

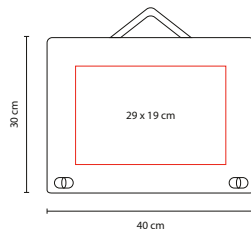

Incluye organizador con 6 compartimentos.



■ **SIN 005**

PORTAFOLIO **STUDENT**

Material: Poliéster
 Medida: 39 x 31 x 10.5 cm
 Área de Impresión: 28 x 10 cm
 Técnica de Impresión: Bordado /
 Serigrafía
 Colores: Negro
 ■ Colores GTM: Negro

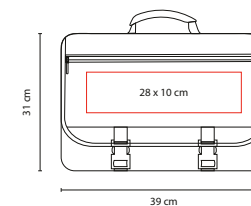

Espacio para laptop, tarjetas y documentos. Bolsa frontal.



R

to^{ss}h

■ SIN 117

PORTAFOLIO HALLEY

Material: Poliéster
 Medida: 29 x 36 x 6.5 cm
 Área de Impresión: 8 x 9 cm
 Técnica de Impresión: Bordado / Serigrafía
 Colores: A/R

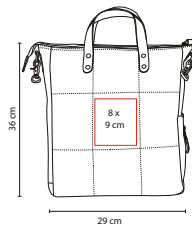

A



Bolsa principal y frontal. Espacio para laptop de 13".
 Bolsa interna con cierre y red.



■ SIN 475

PORTAFOLIO GANDRIA

Material: Poliéster
 Medida: 39.5 x 29 x 5 cm
 Área de Impresión: 26 x 14 cm
 Técnica de Impresión: Bordado / Serigrafía
 Colores: Negro

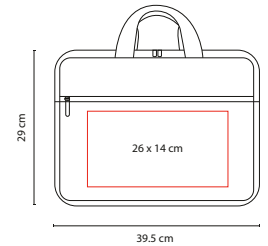

■ Colores GTM: Negro

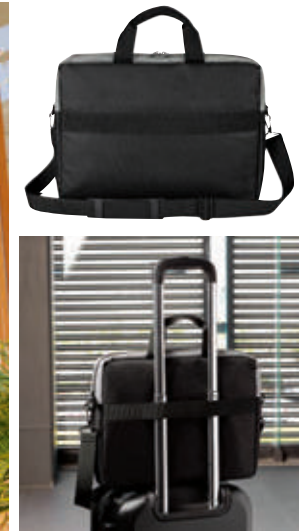

Bolsa principal y frontal. Incluye correa para colgar en hombros y aditamento especial trasero para poner en trolley.





toSSH®

■ SIN 452

PORTAFOLIO XIA

Material: Poliéster
 Medida: 38 x 28 x 6.5 cm
 Área de Impresión: 15 x 15 cm
 Técnica de Impresión: Bordado / Serigrafía
 Colores: Negro

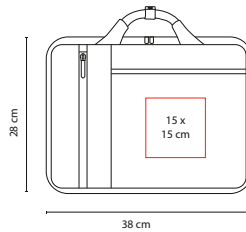

Bolsa principal con espacio para laptop de 15" y tablet. Organizador de documentos interno.
 2 Bolsas frontales con cierre. Aditamento especial trasero para poner en trolley.
 Incluye correa para colgar en hombros.



■ SIN 001

PORTAFOLIO EJECUTIVO

Material: Curpiel
 Medida: 39 x 29 x 7 cm
 Área de Impresión: 24 x 8 cm
 Técnica de Impresión: Bordado / Serigrafía
 Colores: Negro
 Colores GTM: Negro

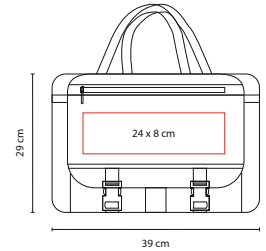

Espacio para laptop, tarjetas y documentos. Bolsa frontal.

MALETAS



■ SIN 132

MALETA LYRA

Material: Poliéster / Malla
Medida: 43 x 27 x 18.5 cm
Área de Impresión: 20 x 10 cm
Técnica de Impresión: Serigrafía
Colores: A/N/O/P/R/V
■ ■ Colores GTM: A/P/R/V

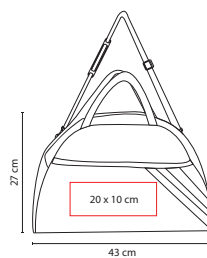

Bolsa principal y frontal. Incluye asa para colgar en hombros.





R

■ SIN 162

MALETA JONIA

Material: Poliéster
 Medida: 50 x 26 x 26 cm
 Área de Impresión: 12 x 12 cm
 Técnica de Impresión: Serigrafía
 Colores: A/N/O/R/V

☑ Colores GTM: A/O/R/V

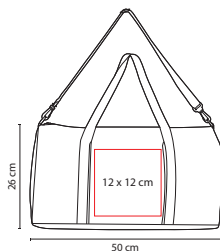

Incluye asa para colgar en hombros.



O

■ SIN 133

MALETA MING

Material: Poliéster
 Medida: 47 x 25 x 20 cm
 Área de Impresión: 12 x 13 cm
 Técnica de Impresión: Bordado / Serigrafía
 Colores: A/O/R

☑ Colores GTM: A/O/R

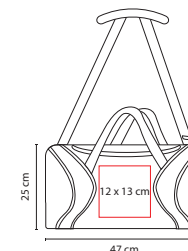

Bolsa de red lateral. Incluye asa para colgar en hombros.



V

■ SIN 032

MALETA SPORT

Material: Poliéster

Medida: 47 x 28 x 16 cm

Área de Impresión: 30 x 6 cm

Técnica de Impresión: Bordado / Serigrafía

Colores: A/O/R/V

■ ■ Colores GTM: A/O/R/V

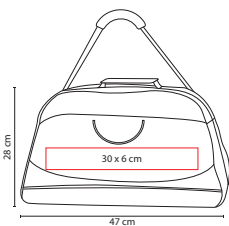

A



R



O

Bolsa principal y frontal. Incluye asa para colgar en hombros.



A

■ SIN 151

MALETA CAIRO

Material: Poliéster

Medida: 50 x 29 x 19 cm

Área de Impresión: 9 x 8 cm

Técnica de Impresión: Bordado / Serigrafía

Colores: A/O/P/R/V

■ ■ Colores GTM: A/O/R/V

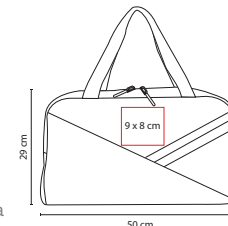

R



P



V



O

Bolsa principal y frontal de red.





0

■ SIN 139

MALETA ODIEL

Material: Poliéster

Medida: 62 x 34 x 23 cm

Área de Impresión: 30 x 12 cm

Técnica de Impresión: Bordado / Serigrafía

Colores: A/O/R/S/V/Y

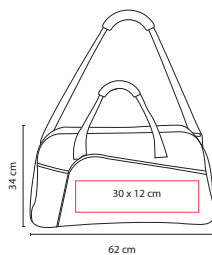

Y



R



S



V



A

Bolsa principal y frontal. Dos compartimentos. Incluye asa para colgar en hombros.



A

■ SIN 165

MALETA KALASIN

Material: Poliéster
 Medida: 22 x 22 cm Cerrada /
 57 x 35 x 21 cm Abierta
 Área de Impresión: 12 x 8 cm Cerrada /
 12 x 8 cm Abierta
 Técnica de Impresión: Serigrafía
 Colores: A/O/R/V

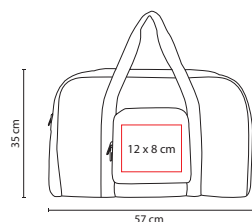

Maleta mágica plegable. Bolsa principal y frontal.



V



R



O



S

■ SIN 503

MALETA MORGAN

Material: Poliéster / Malla
 Medida: 51 x 28 x 24.5 cm
 Área de Impresión: 24 x 11 cm
 Técnica de Impresión: Bordado / Serigrafía
 Colores: A/O/R/S
 ☑ Colores GTM: A/R/S

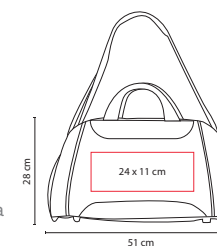

A



R



O

Bolsa principal, frontal para zapatos y compartimento lateral.
 No incluye cilindro. Incluye asa para colgar en hombros.





A

tossh

■ **SIN 960**

MALETA TÍBER

Material: Poliéster
 Medida: 51 x 34 x 22 cm
 Área de Impresión: 23 x 13 cm
 Técnica de Impresión: Bordado / Serigrafía
 Colores: A/O/R/V
 ■ Colores GTM: A/R/V

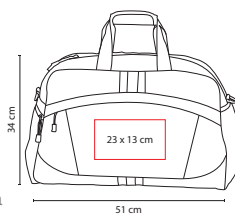

R

O

V

Bolsa principal y frontal. 2 Compartimentos laterales. Incluye asa para colgar en hombros.



V

■ **SIN 306**

MALETA MARRAKECH

Material: 100% Algodón
 Medida: 45 x 25 x 15.5 cm
 Área de Impresión: 30 x 9 cm
 Técnica de Impresión: Bordado / Serigrafía
 Colores: A/C/O/R/V

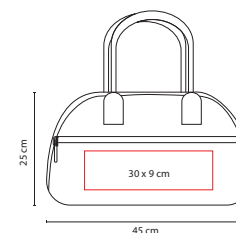

R

O

A

C

Bolsa principal y frontal.



R

■ SIN 028

MALETA TRAVEL

Material: Poliéster

Medida: 65 x 31 x 25 cm

Área de Impresión: 18 x 14 cm

Técnica de Impresión: Bordado / Serigrafía

Colores: A/R

■ ■ Colores GTM: A/R

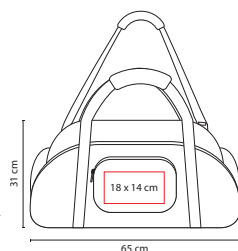

A

Bolsa principal, frontal y 2 laterales. Incluye asa para colgar en hombros.



G

■ SIN 168

MALETA TABUSH

Material: Poliéster

Medida: 49 x 29.5 x 15 cm

Área de Impresión: 16 x 10 cm

Técnica de Impresión: Bordado / Serigrafía

Colores: A/G/R

■ ■ Colores GTM: A/R

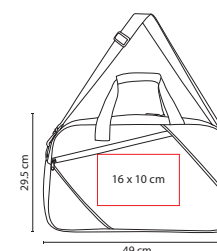

A



R

Bolsa principal, frontal y 1 compartimento lateral de malla. Incluye asa para colgar en hombros.





tossh

■ SIN 187

MALETA IRVIN

Material: Poliéster
 Medida: 59 x 40 x 25 cm
 Área de Impresión: 15 x 13 cm
 Técnica de Impresión: Bordado / Serigrafía
 Colores: Gris Oxford

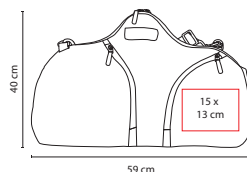

Bolsa principal. Dos bolsas frontales. Una bolsa trasera. Compartimento lateral para zapatos. Incluye asa para colgar en hombros.



G

tossh

■ SIN 106

MALETA VARSOVIA

Material: Poliéster
 Medida: 43 x 31 x 16 cm
 Área de Impresión: 11 x 7 cm
 Técnica de Impresión: Bordado
 Colores: G/N

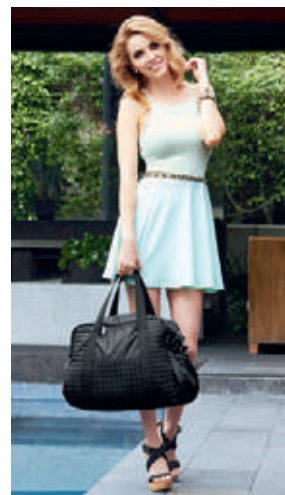
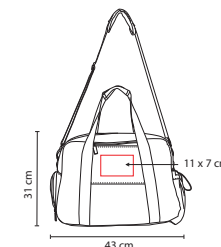

N

Bolsa frontal con cierre. Compartimento para zapatos y bolsa lateral. Bolsa interna con cierre. Incluye asa para colgar en hombros.



R

to^{ss}h®

■ SIN 052

MALETA MEIRA

Material: Poliéster

Medida: 46 x 33 x 20 cm

Área de Impresión: 36 x 15 cm

Técnica de Impresión: Bordado / Serigrafía

Colores: A/G/R

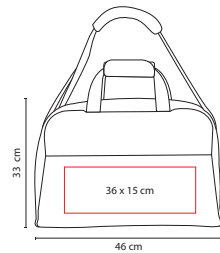

G



A

Bolsa principal con 2 compartimentos de malla y bolsillo para celular. Bolsa frontal con cierre. Agarradera posterior con broche velcro para colocar en trolley. Incluye asa para colgar en hombros.



A

■ SIN 333

MALETA PACIFIC ISLAND

Material: Poliéster / Malla

Medida: 50 x 34 x 23.5 cm

Área de Impresión: 20 x 11 cm

Técnica de Impresión: Bordado / Serigrafía

Colores: A/R

■ ■ Colores GTM: A/R

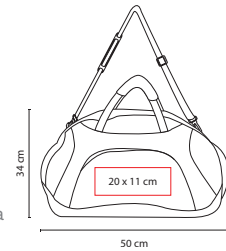

R

Bolsa principal, frontal y 2 compartimentos laterales. Incluye asa para colgar en hombros.





■ SIN 300

MALETA **BLOMSBURY**

Material: Poliéster
 Medida: 57 x 33 x 27 cm
 Área de Impresión: 16 x 10 cm
 Técnica de Impresión: Bordado / Serigrafía
 Colores: Negro con Plata

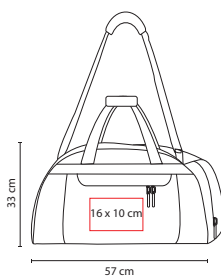

Bolsa principal, frontal y lateral. Incluye asa para colgar en hombros.



R

■ SIN 093

MALETA **ASGARD**

Material: Poliéster
 Medida: 53 x 37 x 27 cm
 Área de Impresión: 29 x 10 cm
 Técnica de Impresión: Bordado / Serigrafía
 Colores: A/R

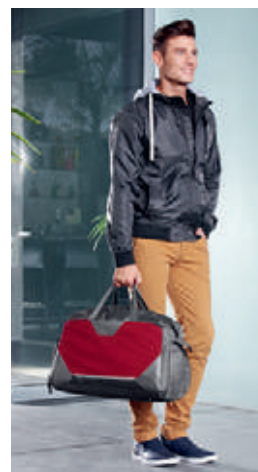
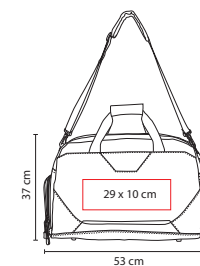

A

Bolsa principal y frontal. Compartimento para zapatos y bolsa lateral. Incluye asa para colgar en hombros.



tossh

■ **SIN 932**

MALETA GALICIA

Material: Poliéster

Medida: 54 x 30 x 18 cm

Área de Impresión: 11 x 8 cm

Técnica de Impresión: Bordado / Serigrafía

Colores: Gris

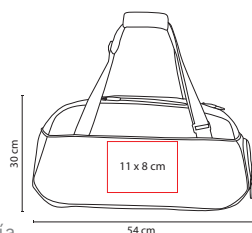

Bolsa principal con dos compartimentos internos. 2 Bolsas frontales. Compartimento lateral para zapatos. Asa de manos ajustable con función doble para colgar en hombros.



■ **SIN 184**

MALETA COLOMBO

Material: Poliéster

Medida: 41 x 30 x 14 cm

Área de Impresión: 21 x 14 cm

Técnica de Impresión: Bordado / Serigrafía

Colores: Blanco con Gris

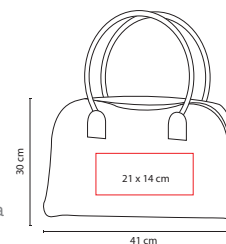



R



■ SIN 307

MALETA ANDINO

Material: Microfibra

Medida: 50 x 33 x 19 cm

Área de Impresión: 27 x 16 cm

Técnica de Impresión: Bordado / Serigrafía

Colores: A/C/R

■ Colores GTM: Café



A



C

Bolsa principal, bolsa frontal con compartimento para celular, bolígrafos y documentos. Incluye asa para colgar en hombros.



■ SIN 911

MALETA HANKO

Material: Poliéster / Curpiel

Medida: 50 x 42 x 28 cm

Área de Impresión: 13 x 13 cm

Técnica de Impresión: Bordado / Serigrafía

Colores: Café

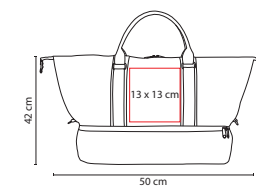

Bolsa principal y compartimento para zapatos.



tossh

■ **SIN 150**

MALETA CADDY

Material: Poliéster
 Medida: 48 x 35 x 27 cm
 Área de Impresión: 27 x 8 cm
 Técnica de Impresión: Bordado / Serigrafía
 Colores: Negro

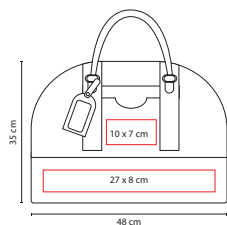

Bolsa principal y compartimento para zapatos. Incluye identificador de maletas.



■ **SIN 905**

MALETA VENECIA

Material: Estireno / Poliéster
 Medida: 34 x 47 x 22 cm
 Área de Impresión: 6.4 x 1.4 cm
 Técnica de Impresión: Láser en Placa Metálica
 Colores: Plata

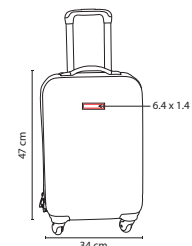

PLACA REMOVIBLE

Maleta trolley 4 ruedas. Incluye 4 compartimentos interiores, placa metálica removible para fácil grabado y candado de seguridad combinación 3 dígitos.





■ SIN 710

MALETA SIERRA NEVADA

Material: Poliéster
 Medida: 62 x 30 x 30 cm
 Área de Impresión: 30 x 5 cm
 Técnica de Impresión: Bordado / Serigrafía
 Colores: Negro con Plata

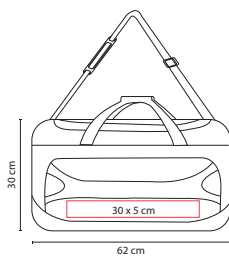

Maleta trolley con bolsa principal y frontal. Incluye asa para colgar en hombros.



tossh ■ SIN 169

MALETA VARENNA

Material: Poliéster
 Medida: 41 x 37 x 19.5 cm
 Área de Impresión: 14 x 14 cm
 Técnica de Impresión: Bordado / Serigrafía
 Colores: Gris

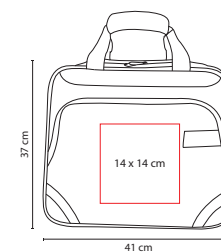

Maleta Trolley. Bolsa principal con cierre en forro, tirantes elásticos internos para ajustar y compartimento con cierre. Bolsa central con espacio para laptop. Bolsa frontal con organizador de documentos. Parte trasera con compartimento con cierre para ocultar trolley. Incluye asas de mano.



to^{ss}h®

■ SIN 068

MALETA FARAH

Material: Curpiel
 Medida: 49 x 35 x 20 cm
 Área de Impresión: 14 x 12 cm
 Técnica de Impresión: Serigrafía
 Colores: Negro

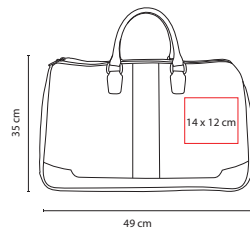

Bolsa principal con cierre interno. Bolsa trasera con cierre. Incluye correa.



■ SIN 917

MALETA BUZZARD

Material: Canvas
 Medida: 48.5 x 28 x 17 cm
 Área de Impresión: 13 x 15 cm
 Técnica de Impresión: Bordado / Serigrafía
 Colores: Café

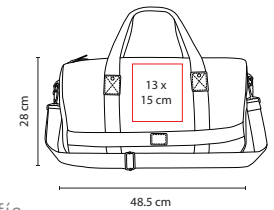

Incluye correa para colgar en hombros.





tossh

■ SIN 930

MALETA DIVE

Material: Poliéster
Medida: 42 x 33 x 17 cm

Área de Impresión: 4 x 2.5 cm

Técnica de Impresión: Láser en Placa Metálica
Colores: Negro

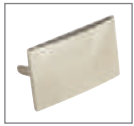

PLACA
REMOVIBLE

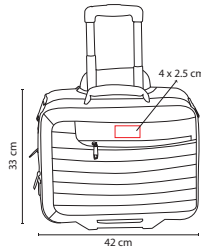

Porta laptop trolley. Bolsa principal y frontal. Compartimento para laptop y organizador de documentos. Separador interior removible. Incluye identificador de maleta en parte posterior, correa ajustable y placa metálica removible para fácil grabado. Incluye asa para colgar en hombros.



tossh

■ SIN 094

MALETA BIFROST

Material: Poliéster
Medida: 35 x 50 x 22 cm

Área de Impresión: 30 x 30 cm

Técnica de Impresión: Bordado / Serigrafía
Colores: Negro

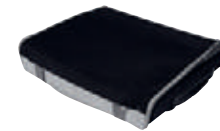
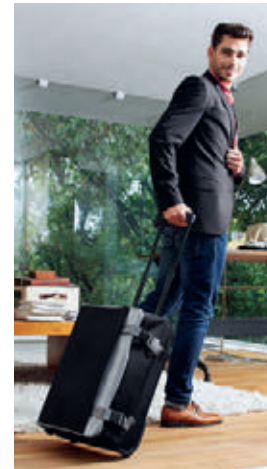
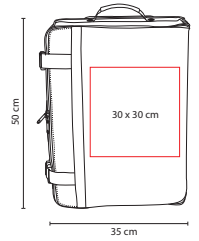

Maleta trolley 2 ruedas. Incluye 2 compartimentos internos con cierre. Maleta plegable.



tossh

■ SIN 952

MALETA RAINIER

Material: Estireno / Poliéster

Medida: 34 x 50 x 20 cm

Área de Impresión: 4 x 2.5 cm

Técnica de Impresión: Láser en Placa Metálica

Colores: Negro

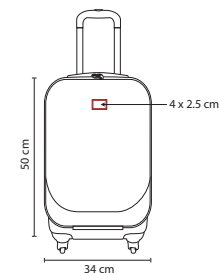

Maleta trolley 4 ruedas. Cierre frontal con espacio para laptop y organizador de documentos. Cierre principal con 2 compartimentos internos. Placa metálica removible para fácil grabado y candado de seguridad con combinación de 3 dígitos. Incluye cables cargadores para conectar batería auxiliar, dispositivos electrónicos y reproductor de audio. Incluye doble puerto de USB, 1 puerto de Micro USB y entrada de audio de 3.5 mm. (No Incluye batería auxiliar).





tossh®



PLACA
REMOVIBLE

■ SIN 154

MALETA IVAR

Material: Poliéster
 Medida: 35 x 48 x 22 cm
 Área de Impresión: 20 x 20 cm Maleta / 4 x 2.5 Placa
 Técnica de Impresión: Bordado / Láser en Placa Metálica
 Colores: Negro
 Colores GTM: Negro

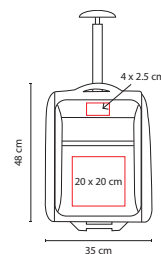

Bolsa frontal y principal. Placa removible para fácil grabado.



tossh®

MALETA VENECIA
SIN 905

Maleta trolley 4 ruedas. Incluye 4 compartimentos interiores, placa metálica removible para fácil grabado y candado de seguridad combinación 3 dígitos.

MALETA DEVONPORT
SIN 091

Maleta trolley 4 ruedas. Cierre frontal con espacio para laptop y organizador de documentos. Cierre principal con 2 compartimentos internos. Placa metálica removible para fácil grabado y candado de seguridad con combinación de 3 dígitos.

MALETA VARENNA
SIN 169

Maleta Trolley. Bolsa principal con cierre en forro, tirantes elásticos internos para ajustar y compartimento con cierre. Bolsa central con espacio para laptop. Bolsa frontal con organizador de documentos. Parte trasera con compartimento con cierre para ocultar trolley. Incluye asas de mano.

MALETA TROLLEY POLUX
SIN 143

Bolsa frontal con compartimento, aditamento especial para audifonos, compartimento para resguardo de tirantes, dos bolsas laterales de red y espacio para laptop.



tossh

■ SIN 091

MALETA DEVONPORT

Material: Estireno / Poliéster

Medida: 34 x 48 x 19 cm

Área de Impresión: 4 x 2.5 cm

Técnica de Impresión: Láser en Placa Metálica

Colores: Negro

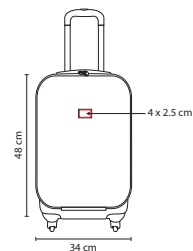

Maleta trolley 4 ruedas. Cierre frontal con espacio para laptop y organizador de documentos.
Cierre principal con 2 compartimentos internos.
Placa metálica removible para fácil grabado y candado de seguridad con combinación de 3 dígitos.

TECNOLOGÍA



ACCESORIOS SMARTPHONE Y TABLET



■ CEL 030

SOPORTE **PIXBAY**

Material: Plástico
Medida: 8.6 x 5.5 cm
Área de Impresión: 4.5 x 2 cm
Técnica de Impresión: Serigrafía
Colores: Translúcido

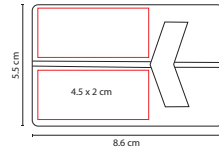

Base para celular con forma de tarjeta de presentación.



R

■ CEL 006

SOPORTE **BRESSOL**

Material: Plástico
Medida: 4.7 x 4.7 cm
Área de Impresión: 2.3 x 1.1 cm
Técnica de Impresión: Serigrafía
Colores: A/R

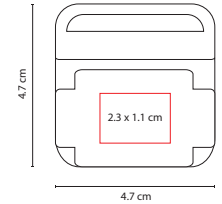

A



SopORTE para smartphone con limpia pantallas.



■ CEL 026

SOPORTE KANURI

Material: Plástico
 Medida: 4.4 x 5.8 cm
 Área de Impresión: 2.5 x 4 cm
 Técnica de Impresión: Serigrafía
 Colores: Blanco
 ☐ Colores GTM: Blanco



SopORTE para smartphone con aromatizante para auto.
 Se monta en las ventilas del aire acondicionado.



■ CEL 004

SOPORTE SNOW

Material: Plástico
 Medida: 5.1 x 6.2 cm
 Área de Impresión: 3.8 x 1.9 cm
 Técnica de Impresión: Tampografía
 Colores: Blanco
 ☐ Colores GTM: Blanco

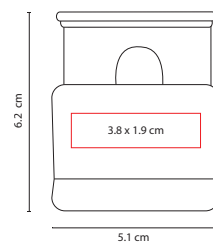

SopORTE para smartphone.



■ CEL 027

SOPORTE SEGINUS

Material: Plástico / Metal
 Medida: 4.4 x 12.3 cm
 Área de Impresión: 3.5 cm Diámetro
 Técnica de Impresión: Serigrafía
 Colores: Blanco



Base para smartphone con limpia pantallas.



■ CEL 023

FUNDA LIRA

Material: Curpiel / Plástico

Medida: 8 x 14.2 cm

Área de Impresión: 5 x 4 cm

Técnica de Impresión: Láser / Serigrafía

Colores: Negro

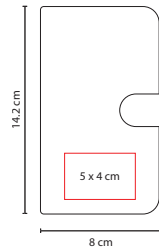

MECANISMO DESLIZABLE PARA TOMAR FOTOGRAFÍAS

Cuenta con compartimento para tarjetas. Broche magnético.
Mecanismo ajustable compatible con smartphones hasta 7.5 cm de ancho.



■ CEL 025

SOPORTE SABIK

Material: Plástico

Medida: 6.9 x 16.5 cm

Área de Impresión: 3 cm Diámetro

Técnica de Impresión: Tampografía

Colores: Blanco

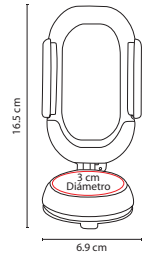

Mecanismo ajustable para smartphones de 4.5 a 9 cm de ancho. Ángulo de rotación de 360°.
Cuenta con ventosa de gel que se adhiere firmemente a tableros y parabrisas.



■ CEL 007

PORTA CELULAR BARI

Material: Plástico
 Medida: 7 x 11.6 cm
 Área de Impresión: 4.5 x 2 cm
 Técnica de Impresión: Serigrafía
 Tinta: Negra
 Colores: Blanco con Gris

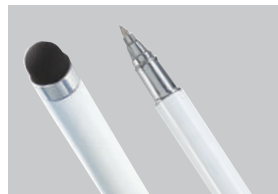
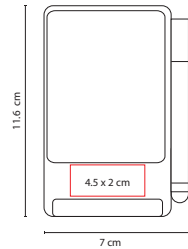

TOUCH SCREEN BOLÍGRAFO

Soporte para smartphone con bolígrafo y touch screen.



■ CEL 034

SOPORTE VOON

Material: Plástico
 Medida: 6.8 x 2.8 cm
 Área de Impresión: 3.5 x 1.5 cm
 Técnica de Impresión: Tampografía
 Colores: Blanco

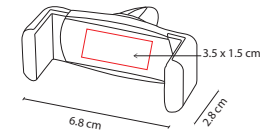

Soporte con mecanismo ajustable para smartphones de 6 a 8 cm de ancho. Se monta en las ventilas del aire acondicionado. Ángulo de rotación de 360°



A

■ CEL 019

FUNDA KEEP

Material: Plástico
 Medida: 9.5 x 22.5 cm
 Área de Impresión: 6 x 2.5 cm
 Técnica de Impresión: Serigrafía
 Colores: A/B
 Colores GTM: Blanco

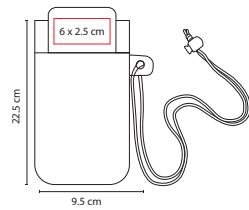

B

Funda para smartphone con cierre hermético a prueba de agua. Compatible con smartphones de 8 x 15 cm máximo. Incluye cordón.



■ CEL 024

SOPORTE KANDER

Material: Plástico
 Medida: 5 x 10.2 cm
 Área de Impresión: 2.5 cm Diámetro
 Técnica de Impresión: Serigrafía
 Colores: Gris

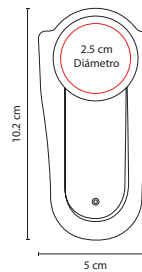

Soporte con adhesivo al reverso para pegarse al smartphone.



R

■ CEL 020

PORTA TARJETAS VIKI

Material: Plástico
 Medida: 9 x 5.5 cm
 Área de Impresión: 8 x 4.5 cm
 Técnica de Impresión: Serigrafía
 Colores: A/B/R



REVERSO CON ADHESIVO

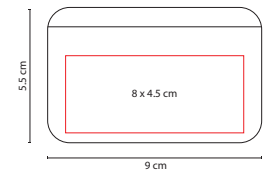

A

B

Porta tarjetas con adhesivo para smartphone.



o

■ TAB 004

FUNDA PARA TABLET **COLETTE**

Material: Neopreno
 Medida: 20 x 25 x 1.5 cm
 Área de Impresión: 17 x 13 cm
 Técnica de Impresión: Serigrafía /
 Goteado en Resina
 Colores: A/N/O/P/R/V

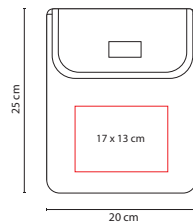

■ TAB 006

FUNDA PARA TABLET **DAIKI**

Material: Poliéster
 Medida: 20 x 28 cm
 Área de Impresión: 10 x 15 cm
 Técnica de Impresión: Bordado / Serigrafía
 Colores: Gris

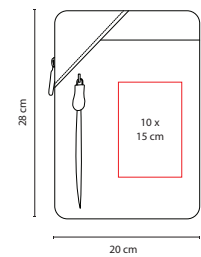

Funda para tablet con broche velcro.



Funda para tablet. El compartimento frontal cuenta con cierre.



tossh®

■ **SIN 260**

PORTA TABLET **ASIER**

Material: Poliéster

Medida: 21 x 25 x 3 cm

Área de Impresión: 14 x 9 cm

Técnica de Impresión: Bordado / Serigrafía

Colores: Gris

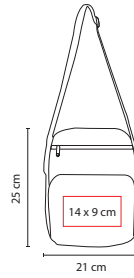

REVERSO



INTERIOR

Bolsa principal y 4 compartimentos adicionales. Aditamento especial para audífonos.



■ **SIN 125**

PORTA TABLET **CELTIC**

Material: Poliéster

Medida: 22 x 27.5 x 3 cm

Área de Impresión: 17 x 11 cm

Técnica de Impresión: Bordado / Serigrafía

Colores: Gris con Naranja

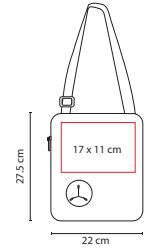

Incluye bolsa trasera y aditamento especial para audífonos.



A

■ TAB 001

FUNDA PARA TABLET **JERSEY**

Material: Neopreno
 Medida: 19.5 x 25 x 1 cm
 Área de Impresión: 15 x 17 cm
 Técnica de Impresión: Serigrafía
 Colores: A/R/S

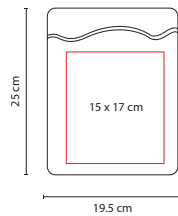

S



R



■ CRG 008

CARGADOR **INOKO**

Material: Plástico
 Medida: 4.2 x 3 cm
 Área de Impresión: 3 x 1.8 cm
 Técnica de Impresión: Goteado en Resina
 Colores: Blanco con Plata

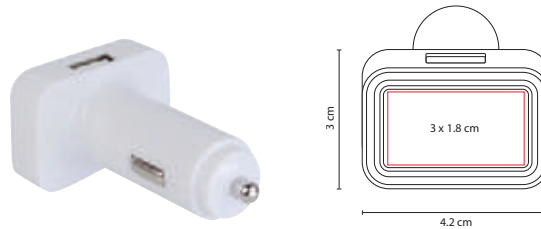

Cargador para automóvil con 2 entradas USB.
 El área de impresión enciende al conectar.



■ CRG 009

CARGADOR **AURE**

Material: Plástico
 Medida: 6.5 x 2 cm
 Área de Impresión: 3 x 1.2 cm
 Técnica de Impresión: Serigrafía
 Colores: Gris con Blanco
 Colores GTM: Gris con Blanco



Cargador para automóvil con entrada USB.



■ CEL 028

MULTI CONTACTO VALGE

Material: Plástico
 Medida: 7.2 x 8.8 cm
 Área de Impresión: 5 x 2 cm
 Técnica de Impresión: Serigrafía
 Colores: Blanco

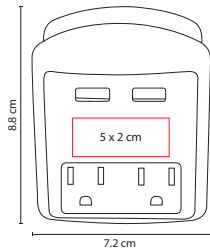

Adaptador de pared con 2 enchufes y 2 puertos USB.



■ CEL 017

ADAPTADOR KARFI

Material: Plástico
 Medida: 3 x 2.7 cm
 Área de Impresión: 1.5 x 2.5 cm
 Técnica de Impresión: Serigrafía
 Colores: Blanco

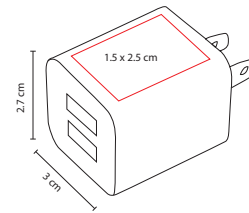

Adaptador de corriente con doble entrada USB para smartphone y tablet.



■ CEL 013

LIMPIA PANTALLAS MIKEL

Material: Plástico
 Medida: 3.8 x 7.2 cm
 Área de Impresión: 2.7 x 2.7 cm
 Técnica de Impresión: Serigrafía / Tampografía
 Colores: Blanco con Gris

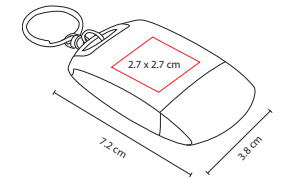

Llavero con franela para limpiar pantallas.



■ SET 007

KIT ADAPATADOR **GOLDBERG**

Material: Plástico
Medida: 6.5 x 8 cm

Área de Impresión: 3.5 x 5 cm
Técnica de Impresión: Serigrafía

Colores: Negro Estuche / Blanco Accesorios

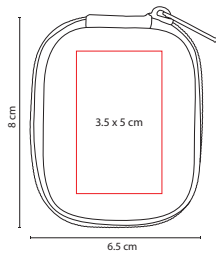

Incluye cargador para automóvil y adaptador de corriente con entrada USB. Incluye estuche.



■ CEL 032

ADAPTADOR **SORK**

Material: Plástico
Medida: 7 x 5 cm

Área de Impresión: 3.5 x 2 cm
Técnica de Impresión: Serigrafía

Colores: Blanco

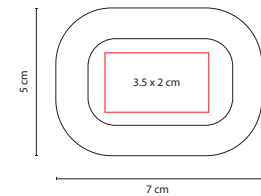

Adaptador de corriente con doble entrada USB para smartphone y tablet.
Función luz de noche con encendido touch y 3 niveles de intensidad.



■ SET 005

KIT LANTAR

Material: Plástico

Medida: 10.5 x 7 cm

Área de Impresión: 8 x 4.5 cm

Técnica de Impresión: Serigrafía

Colores: A/N/R Estuche / Blanco Accesorios

Colores GTM: Negro Estuche / Blanco Accesorios

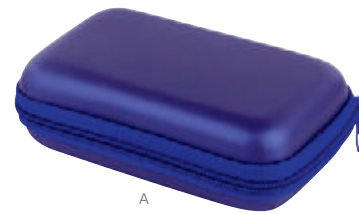
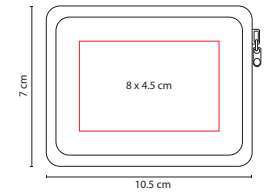

A



R



N

Kit de accesorios para smartphone. Incluye batería auxiliar de 2600 mAh, cargador para automóvil, cargador de pared, audífonos, divisor de audífonos y cable cargador compatible con USB, 30 pin, 8 pin y micro USB. Incluye estuche.



■ SET 008

KIT POWER BANK UMBRIEL

Material: Plástico
Medida: 15 x 10 cm

Área de Impresión: 10 x 6 cm
Técnica de Impresión: Serigrafía

Colores: Negro Estuche / Blanco Accesorios

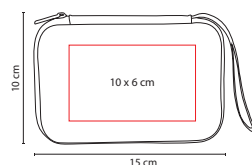

Incluye batería auxiliar de 8000 mAh, cable compatible con USB y micro USB, cargador para automóvil con 2 puertos USB, audífonos y estuche.



■ SET 006

KIT KEIBU

Material: Plástico
Medida: 16.3 x 10 cm

Área de Impresión: 12 x 6.6 cm
Técnica de Impresión: Serigrafía

Colores: Negro Estuche / Blanco Accesorios



Incluye mini selfie stick, batería auxiliar de 2200 mAh con cable USB-Micro USB y adaptador de corriente con entrada USB. Incluye estuche.



■ AST 024

ORGANIZADOR BÁRIK

Material: Poliéster
 Medida: 22 x 10 cm
 Área de Impresión: 16 x 5 cm
 Técnica de Impresión: Serigrafía
 Colores: Gris

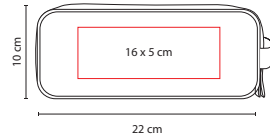

Organizador para accesorios de tecnología con dos compartimentos. Cuenta con divisiones para guardar memoria Micro SD, USB, cables, cargadores, cámara, mouse, etc.



■ CRG 011

CABLE BATARI

Material: Plástico
 Medida: 5 cm Diámetro
 Área de Impresión: 3.5 cm Diámetro
 Técnica de Impresión: Serigrafía
 Colores: Gris con Blanco
 Colores GTM: Gris con Blanco



Set de cables para cargar el smartphone. Compatible con USB, 8 pin y micro USB.



■ CEL 018

CABLE DHENA

Material: Plástico
 Medida: 6.5 x 2.5 cm
 Área de Impresión: 2.5 x 1 cm
 Técnica de Impresión: Serigrafía
 Colores: A/B/R

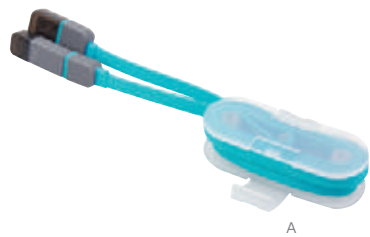
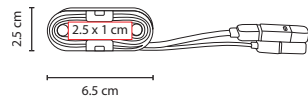

Cable cargador y para transferencia de datos. Compatible con USB, 8 pin y micro USB. Incluye sujetador de cables. Longitud de cable 95 cm.



■ CEL 033

CABLE FERN

Material: Plástico
 Medida: 13.5 x 4 cm
 Área de Impresión: 4 cm Diámetro
 Técnica de Impresión: Serigrafía
 Colores: A/B/R
 ■ ■ Colores GTM: Blanco

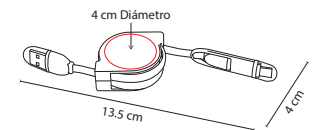

Cable retráctil cargador y para transferencia de datos. Compatible con USB, 8 pin, micro USB y entrada tipo C. Incluye protectores para los conectores. Longitud de cable 1 m aproximadamente.



■ CEL 029

CABLE BASKIR

Material: Plástico
 Medida: 9.5 x 4.4 cm
 Área de Impresión: 2.7 cm Diámetro
 Técnica de Impresión: Serigrafía
 Colores: A/O/R/V

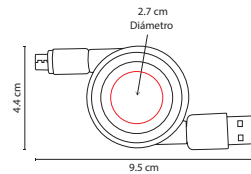

Cable retráctil cargador y para transferencia de datos. Compatible con USB y micro USB. El marco de color enciende al conectarse. Longitud de cable 73 cm aprox.



■ TCH 002

APUNTADOR LITEN

Material: Plástico
 Medida: 1.6 x 9.6 cm
 Área de Impresión: 0.9 x 3.8 cm
 Técnica de Impresión: Serigrafía
 Colores: Plata
 Colores GTM: Plata

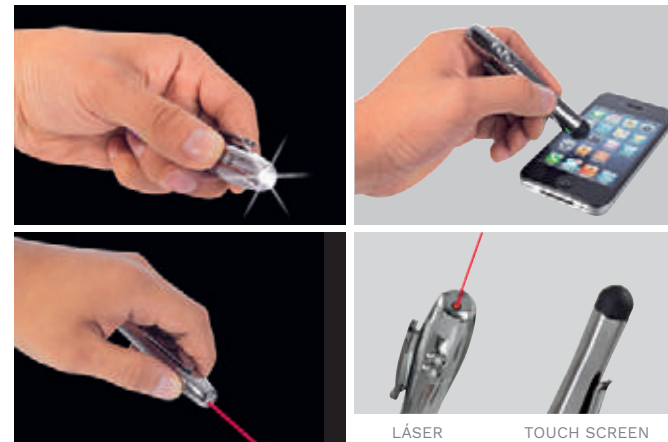
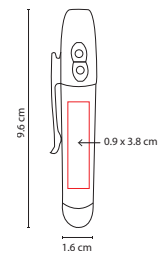

Touch screen con lámpara y láser. Incluye baterías.



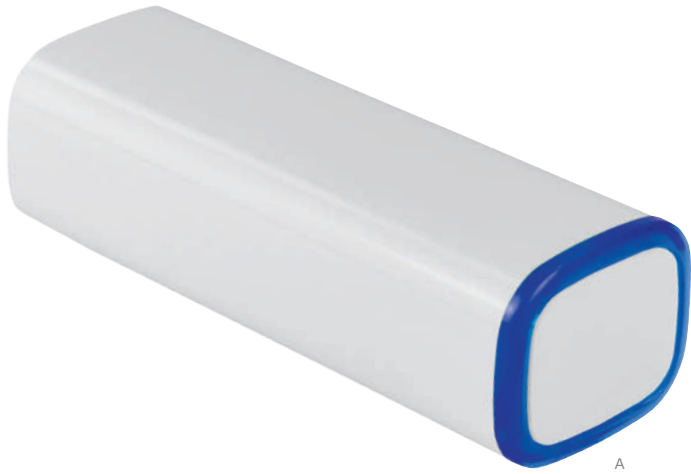

A

■ CRG 022

POWER BANK HADAR

Material: Plástico
Medida: 8.4 x 3 cm

Área de Impresión: 2 x 1.3 cm Placa /
6 x 1.2 cm Cuerpo

Técnica de Impresión: Serigrafía

Colores: A/O/R/V

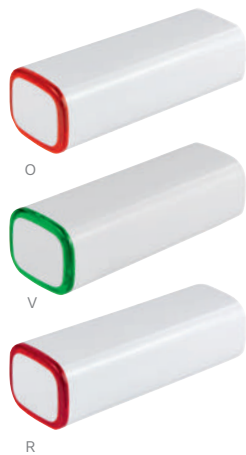
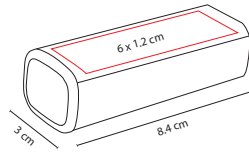

Batería auxiliar para smartphone, capacidad 2200 mAh.
Incluye cable cargador compatible con USB y micro USB. El marco de color enciende al conectarse.



V

■ CRG 005

POWER BANK KASEN

Material: Plástico
Medida: 9.5 x 2.5 cm

Área de Impresión: 6 x 1 cm

Técnica de Impresión: Serigrafía

Colores: A/B/R/V

■ ■ Colores GTM: A/B

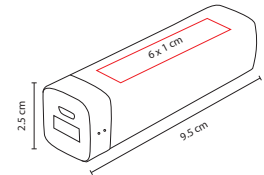

Batería auxiliar para smartphone, capacidad 2600 mAh.
Incluye cable cargador compatible con USB, 30 pin, 8 pin y micro USB.



■ **CRG 019**

POWER BANK **NUANCE**

Material: Plástico
 Medida: 2.5 x 9.9 cm
 Área de Impresión: 8 x 9.5 cm Papel /
 1 x 8 cm Cilindro
 Técnica de Impresión: Serigrafía /
 Tampografía / Impresión Digital en Papel
 Colores: Blanco

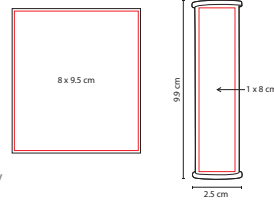

Batería auxiliar para smartphone, capacidad 2000 mAh.
 Incluye papel para impresión y cable cargador compatible
 con USB y micro USB.



A

■ **CRG 015**

POWER BANK **ALIOTH**

Material: Plástico
 Medida: 9.8 x 2.8 cm
 Área de Impresión: 6 x 1 cm
 Técnica de Impresión: Tampografía
 Colores: A/R

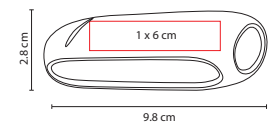

R

Batería auxiliar para smartphone, capacidad 2200 mAh.
 Incluye cable cargador compatible con USB y micro USB.



R



■ CRG 014

POWER BANK GALLIA

Material: Aluminio / Plástico
 Medida: 10.6 x 2.3 cm
 Área de Impresión: 5 x 1 cm
 Técnica de Impresión: Tampografía
 Colores: A/R/S



A



S



Batería auxiliar para smartphone. Cuenta con linterna y correa de mano. Capacidad 2200 mAh. Incluye cable cargador compatible con USB y micro USB.



A

■ CRG 024

POWER BANK HARGY

Material: Plástico
 Medida: 4.3 x 9.5 cm
 Área de Impresión: 2 x 5 cm
 Técnica de Impresión: Serigrafía
 Colores: A/B/R
 Colores GTM: Blanco

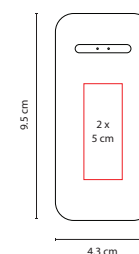

B



R



Batería auxiliar para smartphone, capacidad 2400 mAh. Incluye cable cargador compatible con USB y micro USB.





■ CRG 007

POWER BANK IBOR

Material: Metal / Plástico
 Medida: 10 x 2.3 cm
 Área de Impresión: 7 x 1 cm
 Técnica de Impresión: Serigrafía
 Colores: Plata

■ Colores GTM: Plata

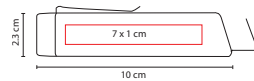

Batería auxiliar para smartphone, capacidad 2200 mAh.
 Incluye cable cargador compatible con USB, 30 pin, 8 pin y micro USB.



■ CRG 020

POWER BANK KENAI

Material: Plástico
 Medida: 6.4 x 9.8 cm
 Área de Impresión: 4 x 6.5 cm
 Técnica de Impresión: Serigrafía
 Colores: Blanco

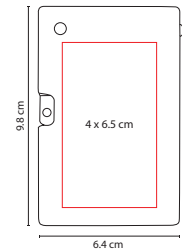

Batería auxiliar para smartphone, capacidad 5000 mAh y doble puerto USB.
 Cuenta con clavija para conectarse a un enchufe de pared y conector para cargador de carro.
 Agitar para verificar el nivel de batería. Incluye cable cargador compatible con USB y micro USB.



■ CRG 012

POWER BANK **DESNA**

Material: Aluminio / Plástico
Medida: 2.1 x 9.1 cm
Área de Impresión: 1 x 6 cm
Técnica de Impresión: Tampografía
Colores: Plata

Colores GTM: Plata

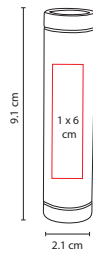

Batería auxiliar para smartphone, capacidad 2000 mAh.
Incluye cable cargador compatible con USB y micro USB.



■ CRG 027

POWER BANK **ALAID**

Material: Plástico
Medida: 6.4 x 14.4 cm
Área de Impresión: 4 x 7.5 cm
Técnica de Impresión: Serigrafía
Colores: Blanco

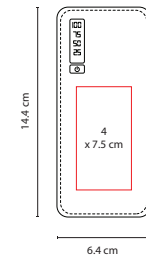

Batería auxiliar para smartphone con 3 salidas de carga, capacidad 7500 mAh.
Incluye cable cargador compatible con USB y micro USB. Display indicador de batería.



■ Z 900

BOCINA CARGADOR LAUREN

Material: Plástico

Medida: 2.7 x 13.4 cm

Área de Impresión: 1.2 x 10 cm

Técnica de Impresión: Tampografía / Serigrafía

Colores: Blanco

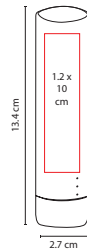

Doble función: Bocina bluetooth y batería portátil de 4000 mAh.
Incluye cable cargador compatible con USB y micro USB.



■ CRG 021

POWER BANK ONUS

Material: Plástico

Medida: 16 x 9.5 cm

Área de Impresión: 12 x 4.5 cm

Técnica de Impresión: Serigrafía

Colores: Negro

Colores GTM: Negro

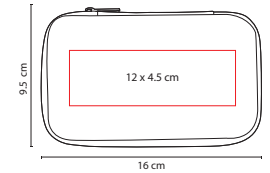

Batería auxiliar para smartphone, capacidad 10,000 mAh.
Cuenta con 2 salidas USB, linterna de 1 LED y display para mostrar el nivel de batería.
Incluye estuche y cable cargador compatible con USB y micro USB.



■ CRG 016

POWER BANK VOLANS

Material: Plástico
 Medida: 5.1 x 12.2 cm
 Área de Impresión: 3 x 6 cm
 Técnica de Impresión: Serigrafía / Tampografía
 Colores: Plata

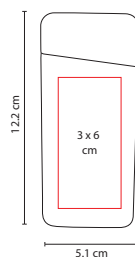

Batería auxiliar para smartphone, capacidad 4000 mAh.
 Incluye cable cargador compatible con USB, 8 pin y micro USB. Cuenta con indicador de batería.



■ CRG 025

POWER BANK KIEV

Material: Plástico
 Medida: 7 x 14.1 cm
 Área de Impresión: 5 x 8 cm
 Técnica de Impresión: Serigrafía
 Colores: Plata

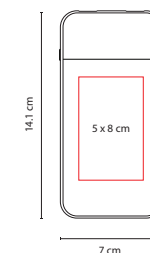

Batería auxiliar para smartphone, capacidad 10,000 mAh.
 Incluye cable cargador compatible con USB y micro USB. Display indicador de batería.





■ CRG 026

POWER BANK NIPET

Material: Plástico
 Medida: 6.3 x 9.1 cm
 Área de Impresión: 4 x 5.5 cm
 Técnica de Impresión: Serigrafía
 Colores: Negro

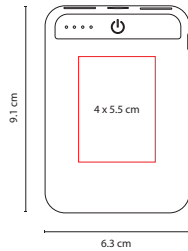

Batería auxiliar para smartphone con linterna LED, capacidad 6000 mAh. Incluye cable cargador compatible con USB y micro USB.



■ CRG 018

POWER BANK WINE TRAVEL

Material: Plástico
 Medida: 3.8 x 10.3 cm
 Área de Impresión: 2 x 8.5 cm
 Técnica de Impresión: Serigrafía
 Colores: Negro
 Colores GTM: Negro

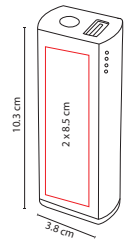

Batería auxiliar para smartphone, capacidad 2200 mAh. Incluye clavija para conectarse a un enchufe de pared y cable cargador compatible con USB y micro USB.



■ SLF 003

SELFIE STICK SAMAJA

Material: Plástico
Medida: 5 x 30 cm

Área de Impresión: 3 x 4.5 cm
Técnica de Impresión: Serigrafía

Colores: A/G/R/V

Colores GTM: Gris

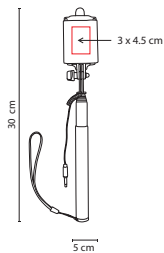

RANURA ANTI-GIRO

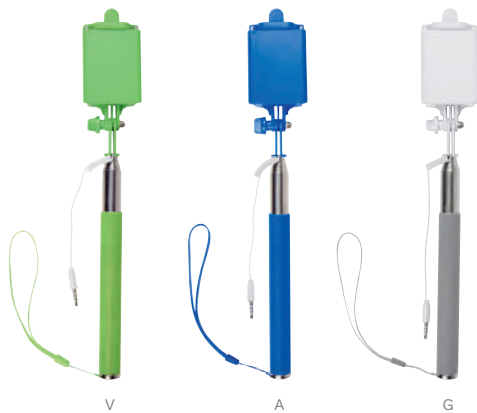

Selfie stick con cable y botón para tomar fotos. Conector de 3.5 mm compatible con la entrada de audio del smartphone. Extensión telescópica para mayor ángulo de foto. Ranura anti-giro. No requiere baterías. Compatible con dispositivos Android 4.2.2 / IOS 5.0.1 o superior. Mide 107 cm extendido aproximadamente. Mecanismo ajustable para smartphones de 6 a 8 cm de ancho.



■ SLF 004

SELFIE STICK SURNA

Material: Plástico/ Aluminio
Medida: 26.5 x 5.4 cm

Área de Impresión: 20 x 2 cm
Técnica de Impresión: Serigrafía Estuche/
Tampografía Selfie

Colores: Gris Metálico

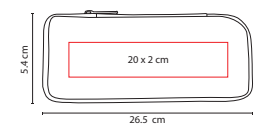

STARTECHNO®



Selfie stick con cable y botón para tomar fotos. Conector de 3.5 mm compatible con la entrada de audio del smartphone. El mango cuenta con batería auxiliar desmontable de 2200 mAh. Extensión telescópica para mayor ángulo de foto. Ranura anti-giro. No requiere baterías. Compatible con dispositivos Android 4.2.2 / IOS 5.0.1 o superior. Mide 68 cm extendido aproximadamente. Incluye estuche. Mecanismo ajustable para smartphones de 6 a 8 cm de ancho.



■ AST 001

VISOR DE REALIDAD VIRTUAL NOX

Material: Plástico
 Medida: 20 x 14 cm
 Área de Impresión: 10 x 5 cm Frente /
 5 x 4 cm Lateral
 Técnica de Impresión: Serigrafía /
 Tampografía
 Colores: Blanco con Negro

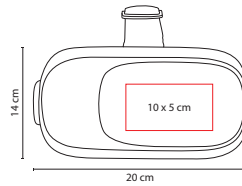

Visor de realidad virtual con almohadilla de contacto facial, lentes ajustables (enfoque y separación IPD).
 Sujetador de smartphone compatible con dispositivos de 8 x 16 cm como máximo.
 Correa ajustable. Se requiere instalar aplicaciones y contenido de realidad virtual en el smartphone (no suministrados).
 No requiere baterías.



AUDIO





R

AUD 004

AUDÍFONOS MELODY

Material: Plástico
 Medida: 5.2 cm Diámetro
 Área de Impresión: 4 cm Diámetro
 Técnica de Impresión: Serigrafía
 Colores: A/R

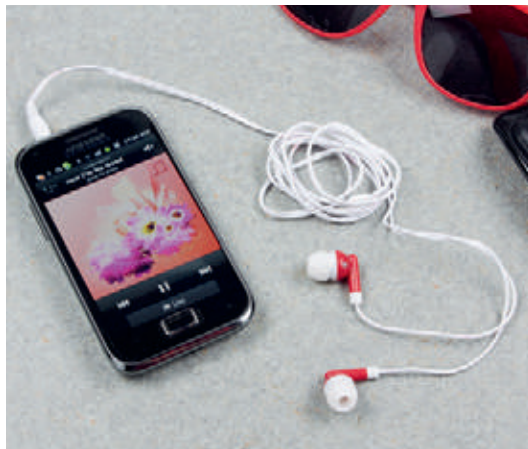
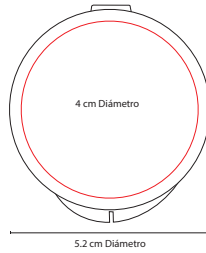

A

Incluye estuche redondo para audífonos.



AUD 007

AUDÍFONOS ZUK

Material: Plástico
 Medida: 6.5 cm Diámetro
 Área de Impresión: 3.5 x 2 cm
 Técnica de Impresión: Serigrafía
 Colores: Blanco con Gris
 Colores GTM: Blanco con Gris

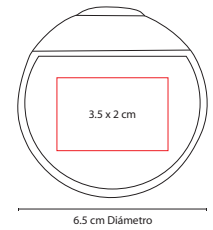

Soporte para smartphone con audífonos enrollables.



AUD 017

AUDÍFONOS **GLIESE**

Material: Plástico
 Medida: 2.2 x 10.5 cm
 Área de Impresión: 1.2 x 3 cm
 Técnica de Impresión: Serigrafía
 Colores: B/N
 Colores GTM: B/N

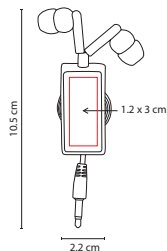

Audífonos retráctiles con clip. Miden 90 cm extendidos aproximadamente.



AUD 018

AUDÍFONOS **CHIMORE**

Material: Plástico
 Medida: 5.8 x 3.5 cm
 Área de Impresión: 4 cm Diámetro
 Técnica de Impresión: Tampografía
 Colores: A/N/R
 Colores GTM: A/N/R

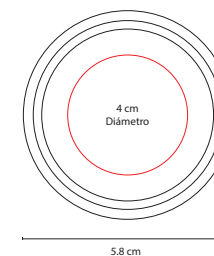

Base para smartphone con audífonos y llavero.



■ AUD 015

AUDÍFONOS BELA

Material: Plástico
 Medida: 6 x 4,4 cm
 Área de Impresión: 3,5 x 2,5 cm
 Técnica de Impresión: Serigrafía
 Colores: Blanco

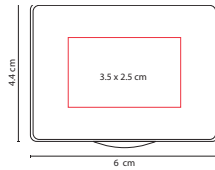

Incluye estuche rectangular para audífonos.



R

■ AUD 008

AUDÍFONOS HUDSON

Material: Plástico
 Medida: 8 x 5 cm
 Área de Impresión: 4 x 2 cm
 Técnica de Impresión: Serigrafía
 Colores: A/B/R

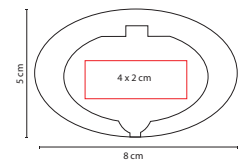

A

B

Audífonos enrollables. Incluye porta audífonos ovalado de plástico y silicón.



■ AUD 009

AUDÍFONOS SPREE

Material: Plástico
 Medida: 3.8 x 7.8 cm
 Área de Impresión: 2 x 5 cm
 Técnica de Impresión: Serigrafía
 Colores: A/B/R

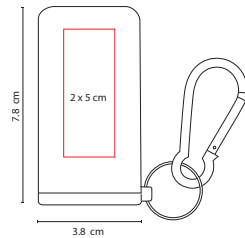

Audífonos enrollables. Incluye porta audífonos con carabina.



■ AUD 019

AUDÍFONOS EUKEN

Material: Plástico
 Medida: 3.5 x 10.8 cm
 Área de Impresión: 2 x 5.5 cm
 Técnica de Impresión: Serigrafía
 Colores: A/B/R

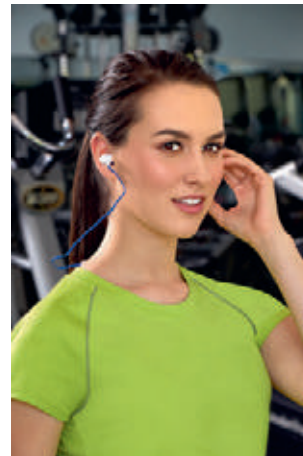
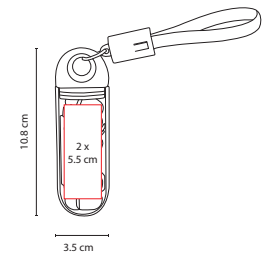

Audífonos bluetooth con batería recargable. Reproducción de música hasta 2 hrs aproximadamente. Controles integrados de llamada, volumen y reproducción de audio. Incluye cable cargador USB y estuche.



AUD 013

AUDÍFONOS LIED

Material: Plástico
Medida: 11 x 12 cm

Área de Impresión: 1.5 cm Diámetro
Técnica de Impresión: Serigrafía / Tampografía
Colores: Blanco

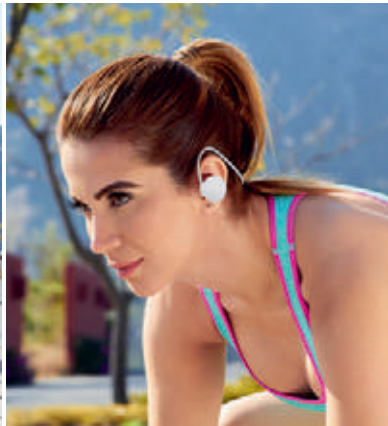
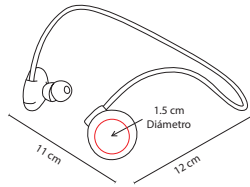

Audífonos bluetooth con batería recargable. Reproducción de música hasta 4 hrs aproximadamente. Incluye cable cargador USB.



AUD 011

AUDÍFONOS LODDON

Material: Plástico
Medida: 5.5 x 5 cm
Área de Impresión: 4 cm Diámetro
Técnica de Impresión: Serigrafía
Colores: Blanco

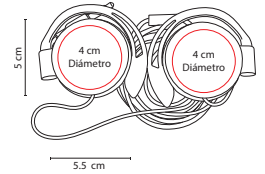

Audífonos acojinados con gancho para oreja. Incluye estuche de PVC para guardar los audífonos.



R

AUD 006

AUDÍFONOS KYAR

Material: Plástico
Medida: 13.5 x 17 cm

Área de Impresión: 3 x 4 cm

Técnica de Impresión: Serigrafía / Tampografía
Colores: A/B/R

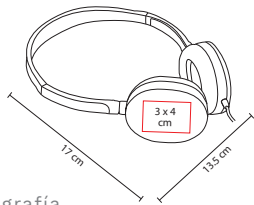

B

A

Audífonos acojinados ajustables con cable entrada auxiliar.



AUD 003

AUDÍFONOS ENJOY

Material: Plástico
Medida: 14 x 16 cm

Área de Impresión: 4 cm Diámetro

Técnica de Impresión: Serigrafía / Tampografía
Colores: Plata con Blanco

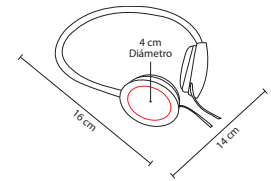

Audífonos acojinados con cable entrada auxiliar.



AUD 010

AUDÍFONOS ORIÓN

Material: Plástico / Aluminio

Medida: 16.5 x 18 cm

Área de Impresión: 3 x 3 cm Tapas /

1.5 x 1 cm Placas

Técnica de Impresión: Tampografía en Tapas /

Láser en Placas

Colores: Gris

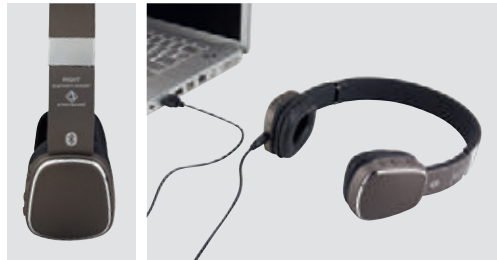
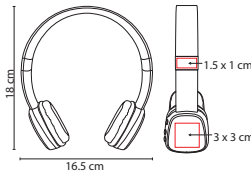

Audífonos bluetooth plegables con audio de alta resolución. Incluye cable cargador USB y funda. Batería interna recargable. Función manos libres. Controles integrados de llamada, volumen y reproducción de audio.



AUD 001

AUDÍFONOS MEGA BEAT

Material: Metal / Plástico

Medida: 14 x 17 cm

Área de Impresión: 10 x 1.5 cm Diadema /

4 cm Diámetro Orejera

Técnica de Impresión: Serigrafía

Colores: Blanco

Colores GTM: Blanco

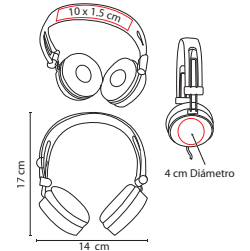

Audífonos acojinados ajustables con cable entrada auxiliar. Incluye funda individual de satín negra.



■ AUD 016

AUDÍFONOS AULAVIK

Material: Plástico / PU

Medida: 13.5 x 19 cm

Área de Impresión: 2 x 5 cm Orejera /
7 x 1.5 cm Diadema

Técnica de Impresión: Tampografía

Colores: Gris

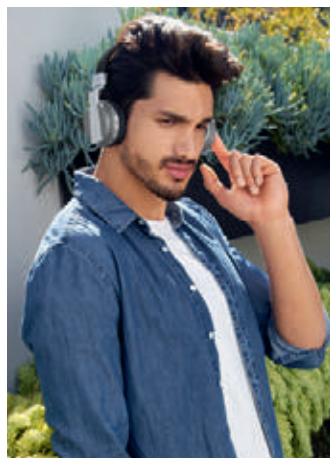
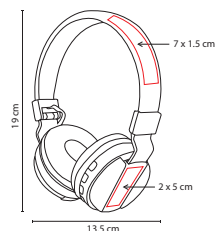

ESTUCHE



Audífonos bluetooth plegables. Incluye cable cargador USB y cable de audio para escuchar música sin necesidad de batería ni bluetooth. Radio FM. Batería interna recargable (4 hrs de música aproximadamente). Función manos libres. Controles integrados de llamada, volumen y reproducción de audio. Diadema acojinada. Incluye estuche.



■ AUD 012

AUDÍFONOS KONSER

Material: Aluminio / Plástico / PU

Medida: 18 x 19.5 cm

Área de Impresión: 1.5 x 3 cm Placas /
6 x 2 cm Diadema

Técnica de Impresión: Láser en Aluminio /
Tampografía en Plástico

Colores: Negro

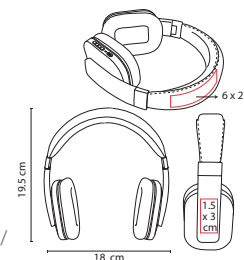

Audífonos bluetooth plegables con audio de alta definición. Incluye cable cargador USB y cable de audio para escuchar música sin necesidad de batería ni bluetooth. Batería interna recargable (14 hrs de música aproximadamente). Función manos libres. Controles integrados de llamada, volumen y reproducción de audio. Diadema acojinada.



■ AUD 005

AUDÍFONOS ONLY

Material: Plástico
Medida: 16 x 19 cm

Área de Impresión: 7 x 1.5 cm Diadema /
4 cm Diámetro Orejera

Técnica de Impresión: Serigrafía /
Goteado en Resina

Colores: Blanco con Negro

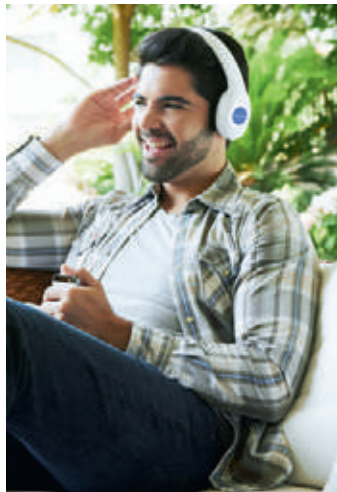
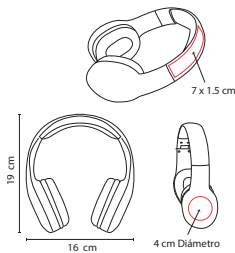

Audífonos plegables, acojinados y ajustables con cable de entrada auxiliar.



■ CAP 009

GORRA BLUETOOTH

Material: Nylon
Talla: Unitalla

Circunferencia Interna: 57 cm
Área de Impresión: 5 x 4 cm

Técnica de Impresión: Bordado / Serigrafía
Colores: Negro



Gorra con audífonos bluetooth, reproductor de audio y llamada con manos libres.
Incluye cable USB y batería de litio recargable. Broche de velcro.



STARTECHNO®



■ AUD 020

AUDÍFONOS LASCAR

Material: Plástico

Medida: 6.5 x 3.6 cm

Área de Impresión: 5 cm Diámetro

Técnica de Impresión: Serigrafía

Colores: Negro

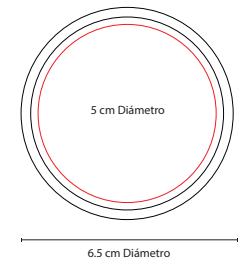

Audífonos bluetooth inalámbricos con batería recargable. Reproducción de música hasta 1.5 hrs aproximadamente. Incluye cable cargador USB y estuche para recargar los audífonos. Función manos libres.



■ Z 900

BOCINA CARGADOR LAUREN

Material: Plástico

Medida: 2.7 x 13.4 cm

Área de Impresión: 1.2 x 10 cm

Técnica de Impresión: Tampografía / Serigrafía

Colores: Blanco

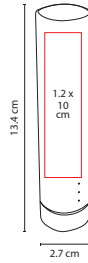

Doble función: Bocina bluetooth y batería portátil de 4000 mAh.
Incluye cable cargador compatible con USB y micro USB.



■ Z 015

BOCINA XIRA

Material: Plástico

Medida: 7 x 5 cm

Área de Impresión: 3.5 x 2 cm

Técnica de Impresión: Tampografía

Colores: Blanco con Gris

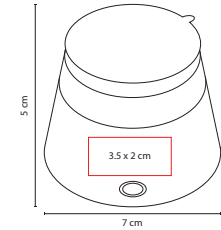

Bocina con ventosa y base retráctil para smartphone. Incluye cable auxiliar y cargador USB.
Batería recargable.



■ Z 200

BOCINA TRENTO

Material: Plástico
 Medida: 5.8 x 8.2 cm
 Área de Impresión: 4.1 x 5.2 cm
 Técnica de Impresión: Serigrafía
 Colores: Blanco con Negro

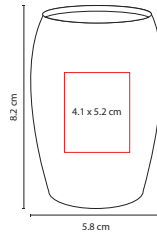

Incluye cable auxiliar, cable USB, instructivo y caja individual. Reproduce archivos MP3 y WMA. Cuenta con lector de tarjeta formato SD. Batería recargable.



■ Z 060

BOCINA VELRY

Material: Plástico
 Medida: 22 x 18 cm
 Área de Impresión: 9 x 3 cm
 Técnica de Impresión: Serigrafía
 Colores: B/N

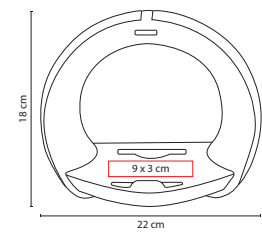

Incluye adaptador de corriente y cable auxiliar compatible con tablet y smartphone. Baterías (3 pilas AAA) no incluidas.



Z 400

BOCINA JÓNICA

Material: Aluminio / Plástico

Medida: 4.5 x 5.5 cm

Área de Impresión: 2.5 x 2.5 cm

Técnica de Impresión: Pantógrafo / Tampografía

Colores: Plata con Negro

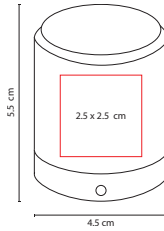

Bocina bluetooth con batería recargable. Incluye cable auxiliar y cable USB.



Z 1020

BOCINA MUZIEK

Material: Aluminio / Plástico

Medida: 6 x 6.5 cm

Área de Impresión: 3 x 3 cm

Técnica de Impresión: Tampografía

Colores: Plata

Colores GTM: Plata

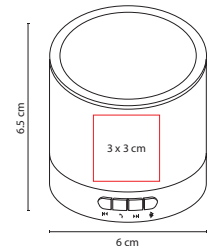

Bocina bluetooth con cable auxiliar y cable USB. Función llamar y contestar. Batería recargable.



■ Z 1030

BOCINA FÉNIX

Material: Plástico
Medida: 5.5 x 4 cm

Área de Impresión: 2 x 1.2 cm
Técnica de Impresión: Serigrafía
Colores: Negro con Plata

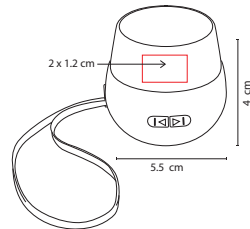

Bocina bluetooth con cable auxiliar y cable USB. Batería recargable. Incluye correa de mano.



■ Z 1070

BOCINA QUIME

Material: Plástico / Metal
Medida: 12.5 x 5.2 cm

Área de Impresión: 4.5 x 1 cm
Técnica de Impresión: Serigrafía
Colores: Plata

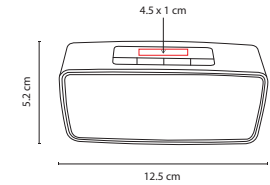

Bocina bluetooth con batería recargable de 2 horas de reproducción. Controles integrados de llamada, volumen y reproducción de audio. Reproducción de tarjeta microSD, modo radio FM, función manos libres. Cable cargador USB incluido.



Z 1060

BOCINA LASSEN

Material: Plástico
 Medida: 40 x 7.5 cm
 Área de Impresión: 4 x 1 cm Placa
 Técnica de Impresión: Láser
 Colores: Gris

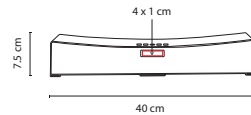

Mini barra de sonido bluetooth de 10W de potencia. Batería recargable con duración de 10 horas aproximadamente. Controles integrados de llamada, volumen y reproducción de audio. Reproducción de tarjeta microSD, modo radio FM, función manos libres. Cable cargador USB y cable de audio incluidos.



Z 1000

BOCINA NEISEE

Material: Plástico / Aluminio
 Medida: 16 x 6.7 cm
 Área de Impresión: 13.5 x 4.5 cm
 Técnica de Impresión: Serigrafía / Láser
 Colores: Negro

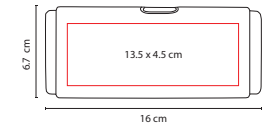

PRESIONAR BOTÓN PARA ENCENDER Y DESPLEGAR BOCINAS.



PRESIONAR LOS EXTREMOS HACIA EL CENTRO DE LA BOCINA PARA APAGAR.

Bocina bluetooth con cable auxiliar y cable USB. Función contestar llamada. Batería recargable. Audio de alta resolución.



N

■ Z 050

BOCINA SAUTI

Material: Plástico
 Medida: 21 x 12.8 cm
 Área de Impresión: 5 x 2 cm
 Técnica de Impresión: Serigrafía
 Colores: B/N
 Colores GTM: B/N

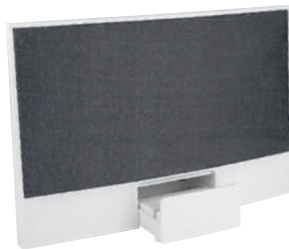
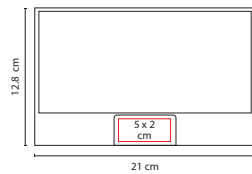

B

Incluye cable auxiliar de 3.5 mm compatible con tablet y smartphone, adaptador de corriente y baterías (3 pilas AA) no incluidas.



■ Z 1050

BOCINA SPEKE

Material: Madera / Plástico/ PU/ Tela
 Medida: 16 x 17.5 cm
 Área de Impresión: 13 x 3.5 cm
 Técnica de Impresión: Serigrafía
 Colores: Gris

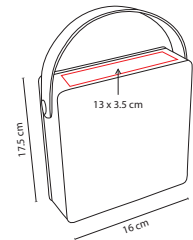

Bocina bluetooth con cable auxiliar y cable USB. Batería recargable.



Z 030

BOCINA SANGEN

Material: Plástico / Tela

Medida: 12.6 x 8 cm

Área de Impresión: 7.5 x 4 cm

Técnica de Impresión: Tampografía

Colores: Gris

Colores GTM: Gris

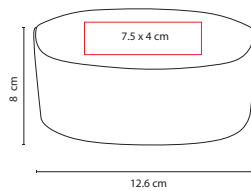

Bocina bluetooth con batería recargable de 3 hrs de reproducción aproximadamente. Incluye cable cargador USB.

ACCESORIOS DE CÓMPUTO

■ HUB 010

CONCENTRADOR DE PUERTOS USB **NEWPORT**

Material: Aluminio / Plástico
 Medida: 9 x 3.8 cm
 Área de Impresión: 7.5 x 1 cm
 Técnica de Impresión: Serigrafía
 Colores: Gris Metálico

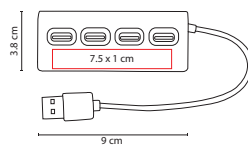

Concentrador con 4 puertos USB 2.0.

■ HUB 09

CONCENTRADOR DE PUERTOS USB **LACERTA**

Material: Plástico
 Medida: 5.1 x 4 cm
 Área de Impresión: 4 x 2 cm
 Técnica de Impresión: Serigrafía
 Colores: Blanco
 Colores GTM: Blanco

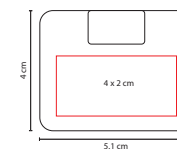

Concentrador con 4 puertos USB 2.0.



■ LAP 009

LÁMPARA LUX

Material: Plástico
 Medida: 2 x 17 cm
 Área de Impresión: 1 x 3 cm
 Técnica de Impresión: Serigrafía
 Colores: Gris



Lámpara USB para laptop. No requiere baterías.



■ LAP 010

CONCENTRADOR DE PUERTOS USB HEZE

Material: Plástico
 Medida: 4.5 x 14.5 cm
 Área de Impresión: 2.5 cm Diámetro
 Técnica de Impresión: Tampografía
 Colores: Blanco



Concentrador con luz de 4 puertos USB 2.0. Incluye botón para encender y apagar la lámpara. Cuerpo flexible. No requiere baterías.



■ BLQ 001



CANDADO SARY

Material: Plástico
 Medida: 2 x 4.3 cm
 Área de Impresión: 1.5 x 1 cm
 Técnica de Impresión: Serigrafía
 Colores: Blanco

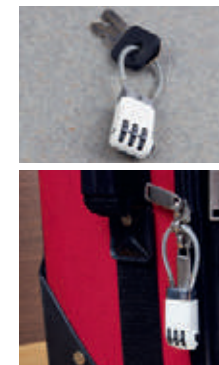
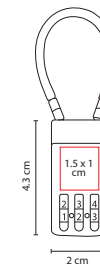

3 Funciones: Llavero, candado para USB para proteger información y candado para maleta. Combinación de 3 dígitos. No incluye USB.



■ LAP 008

VENTILADOR HAVA

Material: Plástico
 Medida: 14 x 14 cm
 Área de Impresión: 3 cm Diámetro
 Técnica de Impresión: Serigrafía
 Colores: Blanco

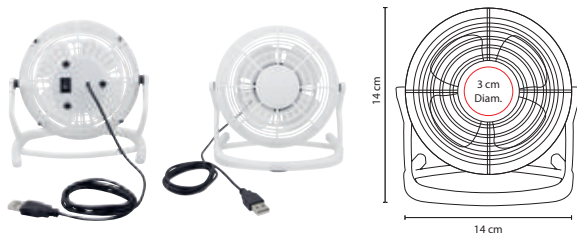

Mini ventilador con cable USB.



■ LAP 011

ATOMIZADOR LUGI

Material: Plástico
 Medida: 3.5 x 10.3 cm
 Área de Impresión: 1.5 x 5 cm
 Técnica de Impresión: Tampografía
 Capacidad: 29.5 ml
 Colores: Transparente

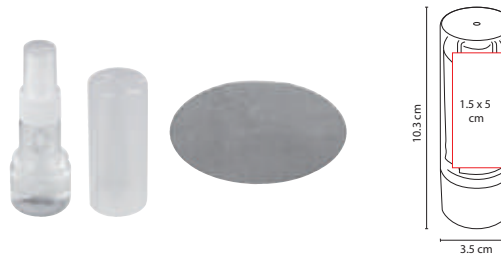

Atomizador con líquido limpia pantallas y microfibra de 12.5 cm de diámetro.



A

■ CD 100

COMPU-CLEAN

Material: Plástico
 Medida: 7.6 x 6.6 cm
 Área de Impresión: 5.4 x 1.7 cm
 Técnica de Impresión: Serigrafía
 Colores: A/N/R
 ■ ■ Colores GTM: A/N/R

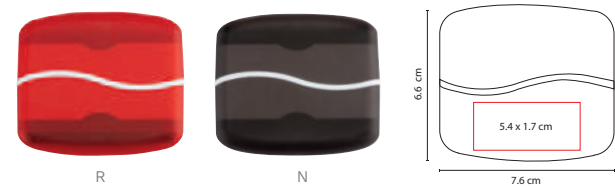

Cepillo para teclado, franela para monitor.



■ HUB 011

CONCENTRADOR DE PUERTOS USB **SHARUNA**

Material: Plástico
 Medida: 7.5 x 7 cm
 Área de Impresión: 2.2 cm Diámetro
 Técnica de Impresión: Serigrafía
 Colores: Blanco

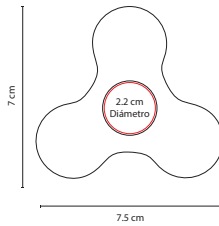

Concentrador con 3 puertos USB 2.0. Incluye cable USB. Funciona como spinner.



■ SET 001

KIT DE CÓMPUTO **TECKY**

Material: Plástico / Tela
 Medida: 16.2 x 19.6 cm
 Área de Impresión: 7 x 11 cm
 Técnica de Impresión: Serigrafía
 Colores: Negro
 Colores GTM: Negro

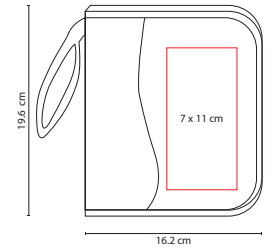

Incluye concentrador de 4 puertos para USB 1.1, mouse retráctil (85 cm) y extensión USB.



R

■ MOP 004

MOUSE PAD **BEAN**

Material: Poliuretano

Medida: 17 x 20.5 cm

Área de Impresión: 17 x 20.5 cm

Técnica de Impresión: Serigrafía /

Sublimación solo en Color Blanco

Colores: A/B/N/R

■ ■ Colores GTM: A/B/N/R

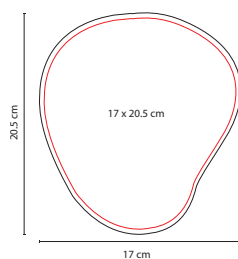

B



A



N

Base antiderrapante.

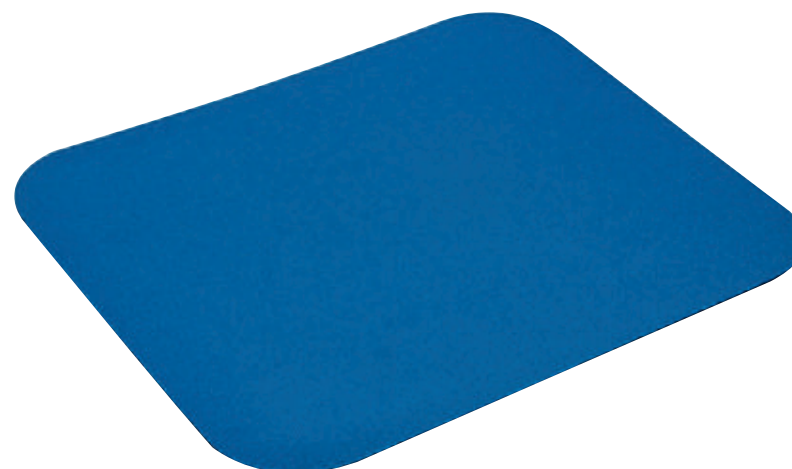

A

■ MOP 002

MOUSE PAD RECTANGULAR

Material: Poliuretano

Medida: 22 x 18.9 cm

Área de Impresión: 22 x 18.9 cm

Técnica de Impresión: Serigrafía /

Sublimación sólo en Color Blanco

Colores: A/B/N/R/V

■ ■ Colores GTM: A/B/N/R/V

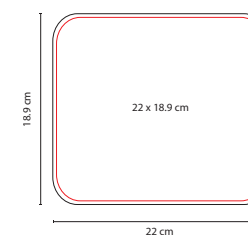

N

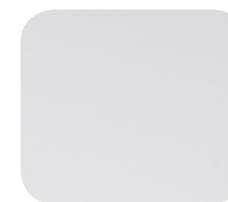

B



R



V

Base antiderrapante.



■ MOP 007

MOUSE PAD CON GEL

Material: Plástico / Tela
 Medida: 20 x 23 cm
 Área de Impresión: 10 x 10 cm
 Técnica de Impresión: Serigrafía
 Colores: Negro
 Colores GTM: Negro

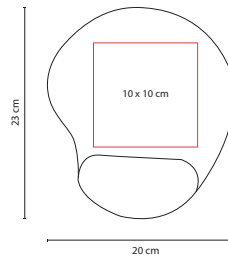

Incluye cojín de gel para descansar la muñeca.

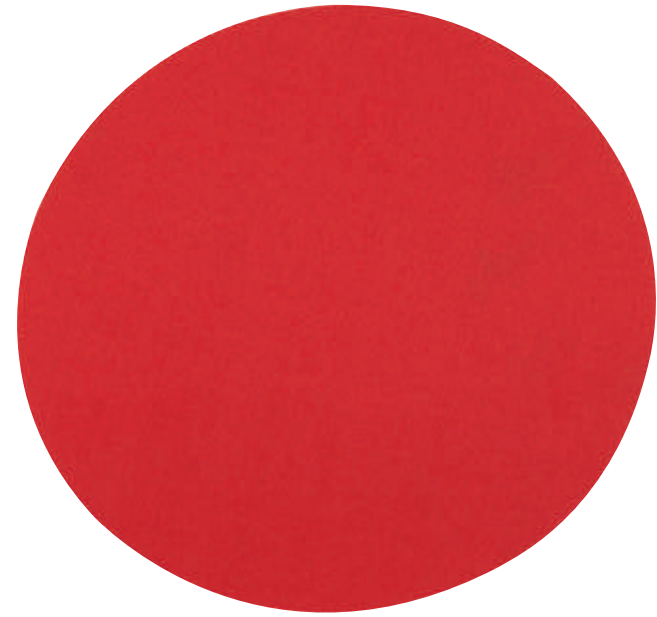

R

■ MOP 001

MOUSE PAD REDONDO

Material: Poliuretano
 Medida: 19.9 cm Diámetro
 Área de Impresión: 19.9 cm Diámetro
 Técnica de Impresión: Serigrafía /
 Sublimación solo en Color Blanco
 Colores: A/B/N/R
 Colores GTM: A/B/N/R

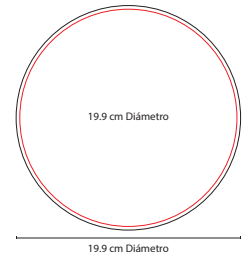

A



B



N

Base antiderrapante.



■ MOU 070

MOUSE INALÁMBRICO ODYSSEY

Material: Plástico
 Medida: 5.8 x 11.3 cm
 Área de Impresión: 4 x 3.2 cm
 Técnica de Impresión: Serigrafía / Tampografía
 Colores: Blanco
 ■ ■ Colores GTM: Blanco

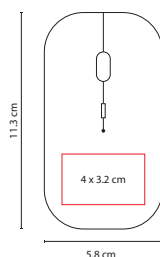

Mouse inalámbrico. Batería (1 pila AA) no incluida.



■ MOU 080

MOUSE INALÁMBRICO NEKAR

Material: Plástico
 Medida: 6.5 x 10.8 cm
 Área de Impresión: 3 x 3 cm
 Técnica de Impresión: Serigrafía / Tampografía
 Colores: Blanco con Gris

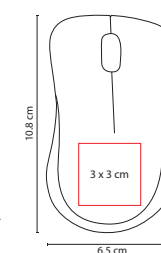

Mouse inalámbrico. Baterías (2 pilas AAA) no incluidas.

U S B



■ USB 013

USB ARGOS

Material: Plástico
Medida: 1.8 x 6 cm
Área de Impresión: 1 x 2.4 cm
Técnica de Impresión: Serigrafía
Capacidad: 4 GB
Colores: A/O/R/S/V

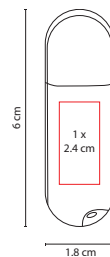

V



O

A

R

S

Tapa translúcida. Incluye caja individual.

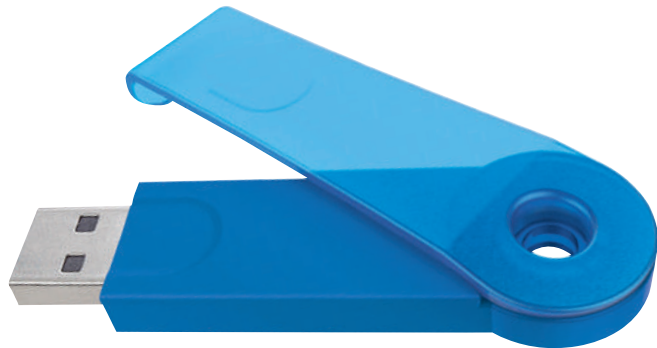

A



■ USB 093

USB GAMKA

Material: Plástico
 Medida: 2.2 x 7.3 cm
 Área de Impresión: 1.2 x 4 cm
 Técnica de Impresión: Serigrafía
 Capacidad: 16 GB
 Colores: A/B/O/R/V

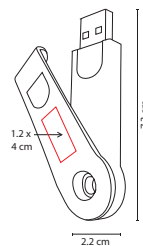

R



B



V



O

Incluye caja individual.



■ USB 126

USB TIRRENO

Material: Plástico Biodegradable
 Medida: 1.7 x 5.4 cm
 Área de Impresión: 0.8 x 3 cm
 Técnica de Impresión: Serigrafía
 Capacidad: 8 GB
 Colores: Beige

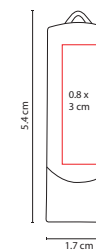

Material reciclado. Incluye caja individual.



O



■ USB 092

USB KINEL

Material: Plástico
Medida: 1.9 x 7.2 cm
Área de Impresión: 1.3 x 2.5 cm
Técnica de Impresión: Serigrafía
Capacidad: 16 GB
Colores: A/B/O/R/V

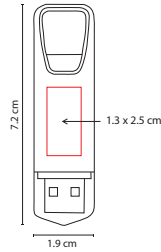

A



R



B



V



Incluye caja individual.

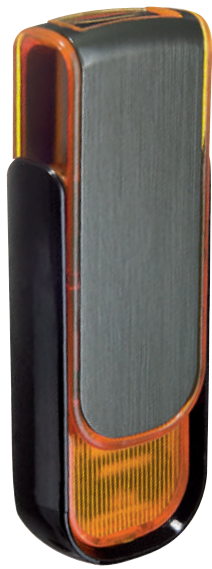

0

■ USB 017

USB PIXEL

Material: Aluminio / Plástico
 Medida: 2 x 5.1 cm
 Área de Impresión: 1.2 x 3 cm
 Técnica de Impresión: Láser / Serigrafía
 Capacidad: 4 GB
 Colores: A/O/R/V

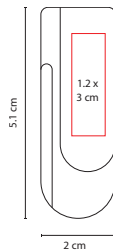

Incluye caja individual.



■ USB 121

USB BOULIA

Material: Hule / Metal
 Medida: 2 x 10 cm
 Área de Impresión: 1 x 2.5 cm
 Técnica de Impresión: Láser / Serigrafía
 Capacidad: 8 GB
 Colores: Negro

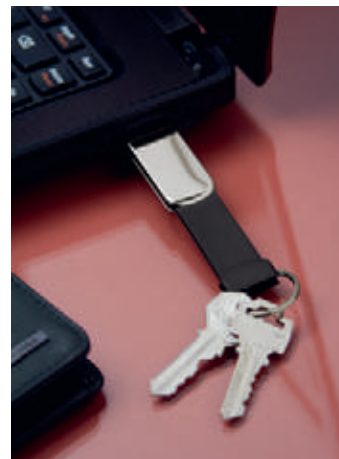
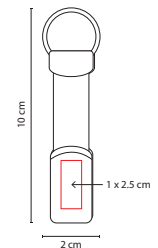

Incluye caja individual.





A

■ USB 231

USB SELWIN

Material: Metal / Rubber

Medida: 2 x 5.6 cm

Área de Impresión: 1.3 x 2.5 cm

Técnica de Impresión: Láser / Pantógrafo / Serigrafía

Capacidad: 16 GB

Colores: A/N/R

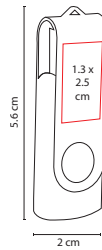

R



N

USB Giratoria. Incluye caja individual.



V

■ USB 091

USB KASARI

Material: Plástico

Medida: 2 x 9 cm

Área de Impresión: 1.3 x 3.5 cm

Técnica de Impresión: Serigrafía

Capacidad: 16 GB

Colores: A/B/O/R/V

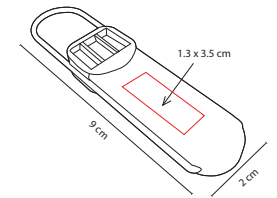

B



R



A



O

Incluye caja individual.



■ USB 031

USB FLOPPY

Material: Metal / Rubber
 Medida: 2 x 5.6 cm
 Área de Impresión: 1.3 x 2.5 cm
 Técnica de Impresión: Láser / Pantógrafo / Serigrafía
 Capacidad: 8 GB
 Colores: A/M/N/O/P/R/V
 Colores GTM: Negro

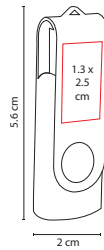

USB Giratoria. Incluye caja individual.



■ USB 104

USB BAWEAN

Material: Metal / PVC
 Medida: 2.4 x 6.6 cm
 Área de Impresión: 1.9 x 3 cm
 Técnica de Impresión: Pantógrafo / Serigrafía
 Capacidad: 8 GB
 Colores: Plata con Negro

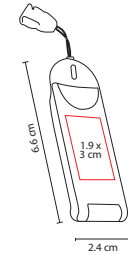

USB con cordón de 46 cm. Incluye caja individual.



A

■ USB 012

USB OMI

Material: Plástico / Tela
 Medida: 3 x 50 cm
 Área de Impresión: 1.8 x 1.8 cm Broche /
 1.3 x 12.4 cm Listón
 Técnica de Impresión: Serigrafía
 Capacidad: 4 GB
 Colores: A/B/R

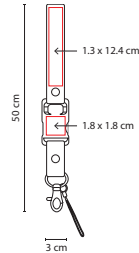

R

B

Incluye colgante para smartphone y caja individual.



R

■ USB 025

USB MORAY

Material: Metal / Rubber
 Medida: 1.8 x 11 cm
 Área de Impresión: 1.2 x 1.8 cm
 Técnica de Impresión: Láser / Serigrafía
 Capacidad: 8 GB
 Colores: A/N/R

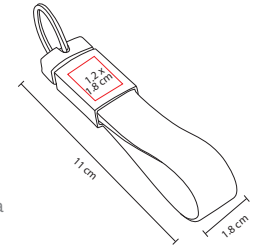

N

A

USB Llavero. Incluye caja individual.



C

■ USB 132

USB TALAUD

Material: Piel / Metal

Medida: 1.3 x 7.7 cm

Área de Impresión: 1 x 2 cm Metal / 0.7 x 2.5 cm Piel

Técnica de Impresión: Láser / Pantógrafo /

Serigrafía / Termograbado

Capacidad: 8 GB

Colores: C/N

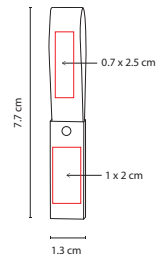

N

Incluye caja individual.



■ USB 131

USB MONTBUI

Material: Plástico / Metal

Medida: 2.3 x 6.3 cm

Área de Impresión: 1.5 x 3.5 cm

Técnica de Impresión: Serigrafía

Capacidad: 16 GB

Colores: Blanco

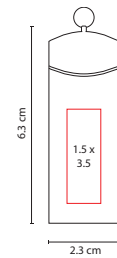

Incluye caja individual.



S

■ USB 120

USB STORAGE

Material: Plástico
 Medida: 2 x 6.6 cm
 Área de Impresión: 1.2 x 2.5 cm
 Técnica de Impresión: Serigrafía
 Capacidad: 8 GB
 Colores: N/S

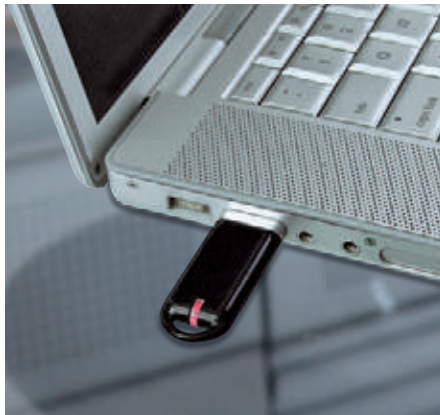
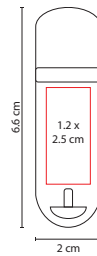

N

Se enciende LED de color al conectar. Incluye caja individual.



■ USB 021

USB LLAVERO MARION

Material: Hule / Metal
 Medida: 2 x 10 cm
 Área de Impresión: 1 x 2.5 cm
 Técnica de Impresión: Láser / Serigrafía
 Capacidad: 4 GB
 Colores: Negro

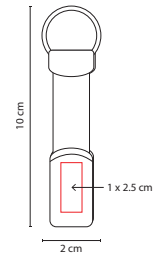

Incluye caja individual.





■ USB 004

USB ZURICH

Material: Metal / PVC
 Medida: 2.4 x 6.6 cm
 Área de Impresión: 1.9 x 3 cm
 Técnica de Impresión: Pantógrafo / Serigrafía
 Capacidad: 4 GB
 Colores: Plata con Negro

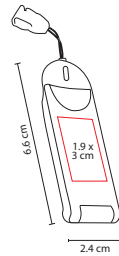

USB con cordón de 46 cm. Incluye caja individual.



■ USB 080

USB HARSTAD

Material: Metal
 Medida: 3 x 5.5 cm
 Área de Impresión: 0.7 x 2 cm
 Técnica de Impresión: Serigrafía
 Capacidad: 8 GB
 Colores: Gris Metálico

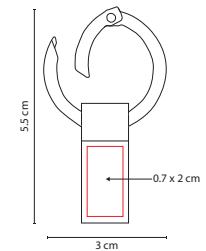

USB Llavero. Incluye caja individual.



■ USB 029

USB TIRSO

Material: Plástico
 Medida: 2.5 x 5 cm
 Área de Impresión: 1 x 1.5 cm
 Técnica de Impresión: Serigrafía / Tampografía
 Capacidad: 8 GB
 Colores: Plata

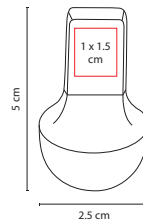

Incluye estuche metálico.



■ USB 007

USB STING

Material: Metal
 Medida: 2.6 x 10.2 cm
 Área de Impresión: 0.9 x 1.5 cm
 Técnica de Impresión: Láser / Pantógrafo
 Capacidad: 4 GB
 Colores: Plata con Negro

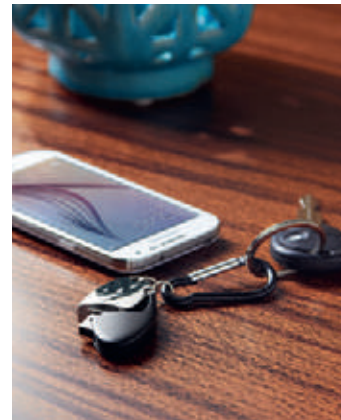
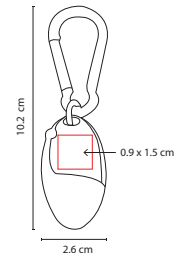

Incluye estuche y carabina.



B



■ USB 040

USB GREIZ

Material: Plástico
 Medida: 2.1 x 6.5 cm
 Área de Impresión: 1.2 x 3 cm
 Técnica de Impresión: Serigrafía
 Capacidad: 8 GB
 Colores: A/B/N

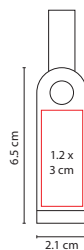

A

N

Incluye caja individual.



■ USB 107

USB DINAGAT

Material: Metal
 Medida: 2.6 x 10.2 cm
 Área de Impresión: 0.9 x 1.5 cm
 Técnica de Impresión: Láser / Pantógrafo
 Capacidad: 8 GB
 Colores: Plata con Negro

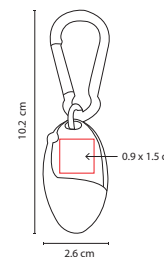

Incluye estuche y carabina.



■ USB 130

USB IMUN

Material: Curpiel / Metal
 Medida: 3.3 x 9 cm
 Área de Impresión: 1.5 x 2 cm
 Técnica de Impresión: Láser /
 Pantógrafo / Serigrafía / Termograbado
 Capacidad: 16 GB
 Colores: Negro

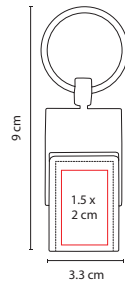

USB Llavero. Incluye caja individual.



■ USB 200

USB WARENDA

Material: Metal
 Medida: 2.4 x 4.1 cm
 Área de Impresión: 2 x 2 cm
 Técnica de Impresión: Goteado en Resina /
 Grabado Espejo
 Capacidad: 8 GB
 Colores: Plata

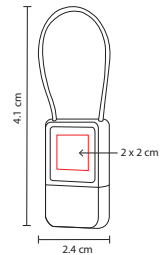

Incluye caja individual.





■ USB 100

USB REGENCY

Material: Metal
 Medida: 2.4 x 4.1 cm
 Área de Impresión: 2 x 2 cm
 Técnica de Impresión: Goteado en Resina /
 Grabado Espejo
 Capacidad: 4 GB
 Colores: Plata

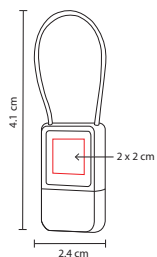

Incluye caja individual.



■ USB 133

USB FRUIT

Material: Plástico / Metal
 Medida: 1.9 x 6.8 cm
 Área de Impresión: 1 x 1 cm
 Técnica de Impresión: Serigrafía
 Capacidad: 8 GB
 Colores: B/N

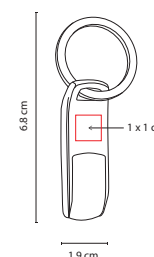

USB Llavero. Incluye caja individual.



■ USB 020

USB MILETO

Material: Curpiel / Metal
Medida: 2.8 x 6 cm

Área de Impresión: 1.5 x 2.5 cm Interior /
1.5 x 3 cm Exterior

Técnica de Impresión: Láser / Pantógrafo /
Serigrafía / Termograbado

Capacidad: 8 GB

Colores: Negro

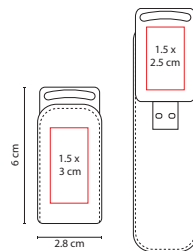

Incluye caja individual.



■ USB 030

USB BYTE

Material: Curpiel / Metal
Medida: 2 x 10 cm

Área de Impresión: 1 x 4.5 cm

Técnica de Impresión: Láser /
Pantógrafo / Serigrafía / Termograbado

Capacidad: 8 GB

Colores: Negro

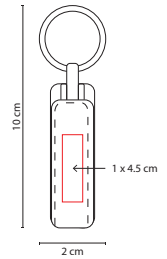

Incluye caja individual.



HOGAR



ACCESORIOS DE COCINA



B



R



A

■ KTC 150

GANCHO KOTY

Material: Plástico

Medida: 6 x 9 cm

Área de Impresión: 3 cm Diámetro

Técnica de Impresión: Serigrafía

Colores: A/B/R

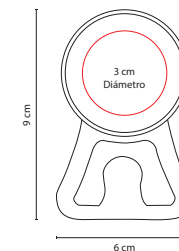

Gancho con chupón multiusos.



A

■ KTC 035

CLIP DESTAPADOR **DINDER**

Material: Plástico
 Medida: 3.5 x 7.5 cm
 Área de Impresión: 2 x 3 cm
 Técnica de Impresión: Serigrafía
 Colores: A/B/R

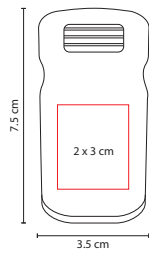

Destapador y clip con imán



B



R



R

■ HL 6500

CLIP PORTA NOTAS **CARVI**

Material: Plástico
 Medida: 7.2 cm Diámetro
 Área de Impresión: 3 x 1 cm
 Técnica de Impresión: Serigrafía
 Colores: A/B/R



B

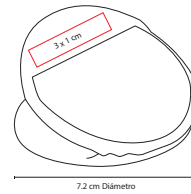

A



Clip porta notas con imán. 30 Notas adhesibles.



■ KTC 027

CUCHARA MEDIDORA **KOST**

Material: Plástico
 Medida: 2.1 x 14 cm
 Área de Impresión: 1 x 2 cm
 Técnica de Impresión: Serigrafía
 Colores: Blanco

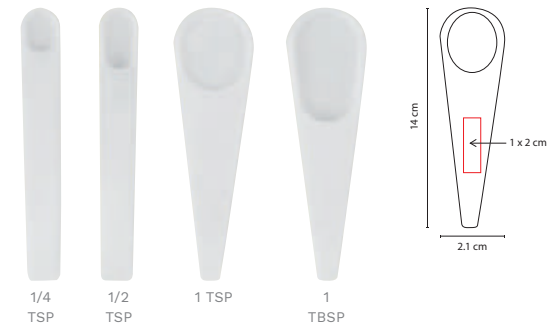

1/4
TSP

1/2
TSP

1 TSP

1
TBSP



Cuchara medidora incluye las medidas: 1 cucharada (1 TBSP), 1 cucharadita (1 TSP), 1/2 cucharadita (1/2 TSP) y 1/4 cucharadita (1/4 TSP).



■ KTC 021

SET DE UTENSILIOS **MERAN**

Material: Plástico
 Medida: 9 x 14 cm Base
 Área de Impresión: 4 x 8 cm
 Técnica de Impresión: Serigrafía / Tampografía
 Colores: Blanco Base / Negro Utensilios

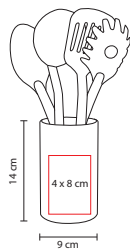

Incluye base y 4 utensilios de cocina: cuchara, cucharón, pala y cuchara de pasta.



■ KTC 025

TAZA MEDIDORA **ZARY**

Material: Plástico
 Medida: 8 x 7 cm
 Área de Impresión: 4 x 3 cm Taza / 2 x 1.5 cm Placa
 Técnica de Impresión: Serigrafía / Tampografía
 Colores: Blanco

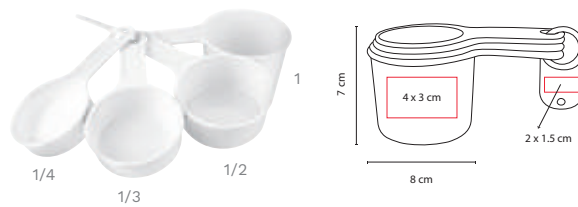

Set de 4 tazas medidoras. Incluye las medidas: 1 taza, 1/2 taza, 1/3 taza y 1/4 taza. Incluye placa plástica para impresión.



■ KTC 005

AGARRADERA **CHOP**

Material: Algodón
 Medida: 18 x 18 cm
 Área de Impresión: 10 x 10 cm
 Técnica de Impresión: Bordado / Serigrafía
 Colores: Blanco

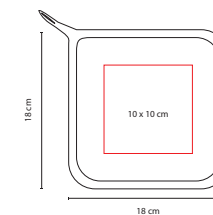

Sujetador de utensilios calientes.



V

■ KTC 009

CUBIERTOS PICNIC

Material: Plástico

Medida: 3 x 17.5 cm

Área de Impresión: 1.5 x 6 cm
Técnica de Impresión: Serigrafía

Colores: A/B/O/R/V

■ ■ Colores GTM: A/B/O/R/V

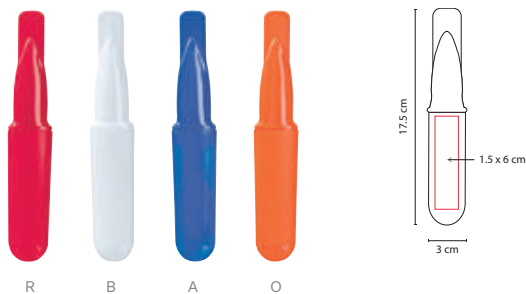

Portacubiertos con tenedor, cuchara y cuchillo.



■ KTC 004

GUANTE PARA COCINA

Material: Algodón

Medida: 15.5 x 25 cm

Área de Impresión: 8 x 10 cm
Técnica de Impresión: Bordado / Serigrafía

Colores: Blanco

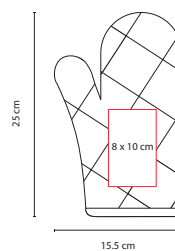

■ KTC 100

SET DE CUCHILLOS CORVI

Material: Acero / Madera / Plástico

Medida: 5 x 22 cm

Área de Impresión: 3.5 x 9 cm Base / 1 x 6 cm Mango

Técnica de Impresión: Láser / Serigrafía

Colores: Beige Base / Negro Cuchillos

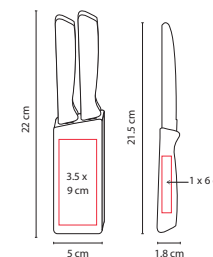

Incluye 6 cuchillos y base de madera.



A

■ KTC 026

MANDIL NEIT

Material: Non Woven
 Medida: 57 x 68 cm
 Área de Impresión: 25 x 15 cm
 Técnica de Impresión: Serigrafía
 Colores: A/B/R
 Colores GTM: A/B/R

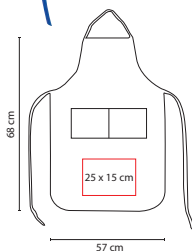

B

R

Incluye 2 bolsas frontales.



■ KTC 003

MANDIL PARA COCINA

Material: Algodón
 Medida: 49.5 x 75.5 cm
 Área de Impresión: 30 x 36 cm
 Técnica de Impresión: Bordado / Serigrafía
 Colores: Blanco

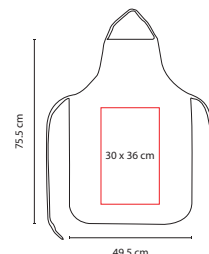



■ KTC 030

DISPENSADOR DE AGUA SENA

Material: Plástico
 Medida: 14.5 x 21.5 cm
 Área de Impresión: 7 x 1.3 cm
 Técnica de Impresión: Serigrafía
 Capacidad: 3.5 Litros
 Colores: Blanco

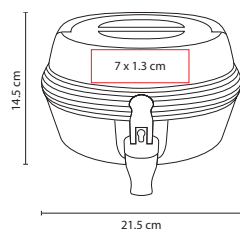

Dispensador de bebidas plegable con capacidad de 3.5 litros.



■ KTC 029

JARRA VIANA

Material: Plástico
 Medida: 14 x 25 cm
 Área de Impresión: 6 x 12 cm
 Técnica de Impresión: Serigrafía
 Capacidad: 1 Litro
 Colores: Blanco

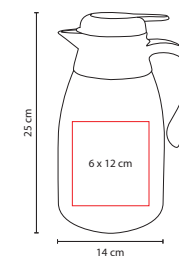

Jarra térmica.





■ KTC 006

SET **BILBAO**

Material: Madera / Metal
 Medida: 9.2 x 14.9 cm
 Área de Impresión: 5 x 5 cm Base
 Técnica de Impresión: Láser / Serigrafía
 Colores: Beige

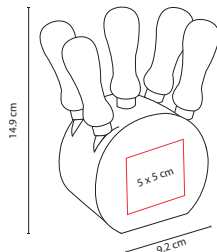

Incluye 5 accesorios de cocina y base de madera.



■ PWT 040

SET **FONTIN**

Material: Madera / Metal
 Medida: 16.5 x 16.8 cm
 Área de Impresión: 10 x 10 cm Estuche /
 1 x 1 cm Mango
 Técnica de Impresión: Láser en Mango /
 Serigrafía en Estuche
 Colores: Beige

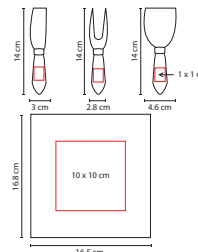

Incluye 3 accesorios de cocina y estuche.



■ PWT 100

SET BRIENZ

Material: Madera / Metal
 Medida: 19 cm Diámetro
 Área de Impresión: 9 cm Diámetro
 Técnica de Impresión: Láser
 Colores: Beige

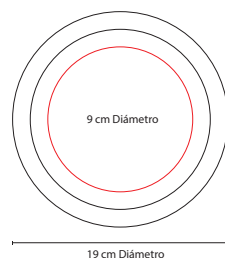

Estuche de madera con 3 accesorios de cocina.



■ PWT 200

TABLA KAVERI

Material: Madera
 Medida: 19 x 28 cm
 Área de Impresión: 15 x 18 cm
 Técnica de Impresión: Láser
 Colores: Café

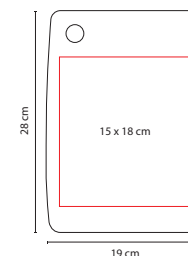



■ PWT 900

SET CASTADEL

Material: Madera / Metal / Cerámica
 Medida: 29.5 x 19.5 cm
 Área de Impresión: 8 x 2 cm
 Técnica de Impresión: Láser
 Colores: Beige

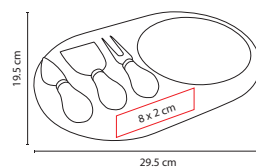

Base con 3 accesorios de cocina y tabla de cerámica.



■ PWT 070

SET LESOTO

Material: Madera / Metal
 Medida: 35.8 x 22.6 cm
 Área de Impresión: 20 x 10 cm Tabla Madera /
 1.5 x 1.5 cm Mango
 Técnica de Impresión: Láser
 Colores: Café



Tabla con 3 accesorios de cocina.



■ PWT 090

TABLA Y CUCHILLOS JARTUM

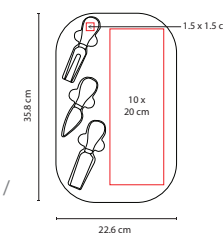
Material: Bambú / Metal
 Medida: 39.8 x 23 cm
 Área de Impresión: 15 x 15 cm
 Técnica de Impresión: Láser
 Colores: Beige



Tabla de cocina. Incluye tenedor y cuchillo.



■ PWT 050

SET VALENCIA

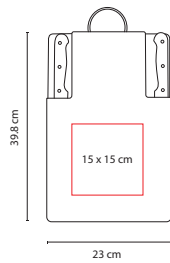
Material: Madera / Metal
 Medida: 29 x 16 cm
 Área de Impresión: 25 x 11 cm Estuche /
 1.5 x 2.5 cm Mango
 Técnica de Impresión: Láser en Mango /
 Serigrafía en Estuche
 Colores: Beige

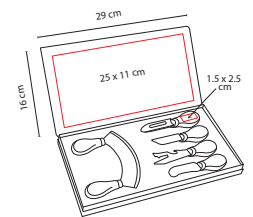

Incluye 5 accesorios de cocina y estuche.



■ PWT 030

SET ASTURIAS

Material: Madera / Metal
 Medida: 31 x 21.5 cm
 Área de Impresión: 25 x 16 cm Estuche /
 15 x 12 cm Tabla
 Técnica de Impresión: Láser en Tabla /
 Serigrafía en Estuche
 Colores: Beige
 Colores GTM: Beige

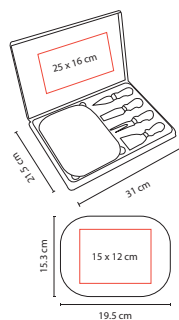

Incluye 4 accesorios de cocina, tabla de madera y estuche.



■ PWT 020

TABLA MARMORE

Material: Madera / Cerámica / Metal
 Medida: 20 x 30 cm
 Área de Impresión: 15 x 15 cm
 Técnica de Impresión: Láser / Serigrafía
 Colores: Beige

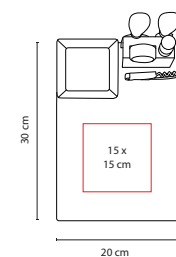

Base con 2 accesorios de cocina, plato de cerámica, sacacorchos con navaja, stopper y arillo.



■ BBQ 042

SET DE BBQ JASPER

Material: Acero Inoxidable / Poliéster

Medida: 40 x 15 cm

Área de Impresión: 11 x 9 cm

Técnica de Impresión: Serigrafía

Colores: Negro

Colores GTM: Negro

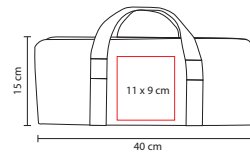

Incluye pinza, tenedor y espátula.



■ BBQ 003

SET DE BBQ SNAZZY

Material: Acero Inoxidable Utensilios /

Aluminio, PVC y Madera Estuche

Medida: 37 x 10 cm

Área de Impresión: 33 x 5.5 cm

Técnica de Impresión: Láser en Utensilios / Serigrafía en Estuche

Colores: Plata

Colores GTM: Plata

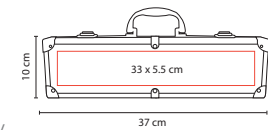

Incluye pinzas, espátula, tenedor para BBQ y estuche metálico.



■ BBQ 010

SET DE BBQ WAHIBA

Material: Acero inoxidable /
Madera / Poliéster

Medida: 43 x 9.5 cm

Área de Impresión: 30 x 7 cm

Técnica de Impresión: Láser / Serigrafía
Colores: Negro

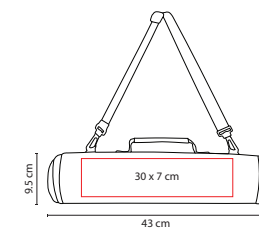

Maletín con correa para colgar en hombro. Incluye pinza, brocha, tenedor, espátula, brochetas y pinchos para mazorcas.



■ BBQ 009

ASADOR KAOKO

Material: Metal
 Medida: 33 x 43 cm
 Área de Impresión: 10 x 7 cm
 Técnica de Impresión: Serigrafía
 Colores: Negro

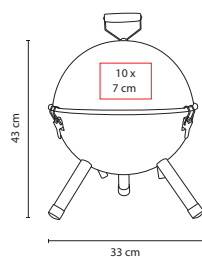

Incluye parrilla.



■ BBQ 002

ASADOR CON HIELERA CAMPING

Material: Metal / Poliéster
 Medida: 29 x 16.5 cm
 Área de Impresión: 12 x 12 cm
 Técnica de Impresión: Bordado / Serigrafía
 Colores: Negro con Gris

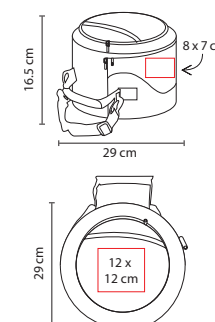

Incluye parrillas. Hielera sólo en la parte superior.



■ BBQ 008

SET DE BBQ **LERNA**

Material: Poliéster / Acero Inoxidable

Medida: 24.5 x 18 cm

Área de Impresión: 12 x 10 cm

Técnica de Impresión: Bordado / Serigrafía

Colores: Negro

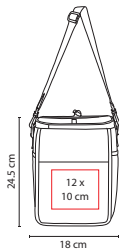

Bolsa principal con función de hielera.

Incluye bolsa frontal con 3 compartimentos internos para el set de cuchillo, espátula y tenedor para BBQ. Incluye asa para colgar en hombros y 2 bolsas laterales de red.



■ KTC 037

SOPORTE DE MANO **HELPFUL**

Material: Plástico

Medida: 29 x 9.5 cm

Área de Impresión: 6 x 1 cm

Técnica de Impresión: Serigrafía

Colores: Gris

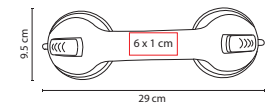

Soporte de mano con 2 ventosas de seguridad. Solo en superficies lisas

B A R





R



LIG 003

MINI ENCENDEDOR IGNI

Material: Plástico
 Medida: 2.2 x 6.2 cm
 Área de Impresión: 1 x 3.5 cm
 Técnica de Impresión: Serigrafía
 Colores: A/B/N/O/R/V



A

B

N

O

V

Encendedor con seguro para niños, recargable y flama regulable.



A



LIG 004

ENCENDEDOR IGNI

Material: Plástico
 Medida: 2.3 x 7 cm
 Área de Impresión: 1 x 4 cm
 Técnica de Impresión: Serigrafía
 Colores: A/B/N/O/R/V

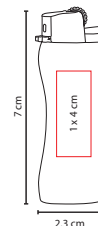

N

V

O

B

R

Encendedor con seguro para niños, recargable y flama regulable.



LIG 001

ENCENDEDOR GIL

Material: Plástico
 Medida: 2.3 x 8 cm
 Área de Impresión: 1.6 x 4.5 cm
 Técnica de Impresión: Serigrafía
 Colores: Blanco

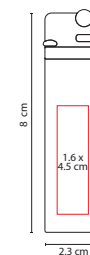

Encendedor desechable. Flama regulable.



■ KTC 200

SET DE PORTAVASOS **PREMIUM**

Material: Curpiel
 Medida: 11 x 12.5 cm Base / 9 x 9 cm Portavasos
 Área de Impresión: 7 x 5 cm
 Técnica de Impresión: Láser / Serigrafía
 Colores: Negro
 Colores GTM: Negro

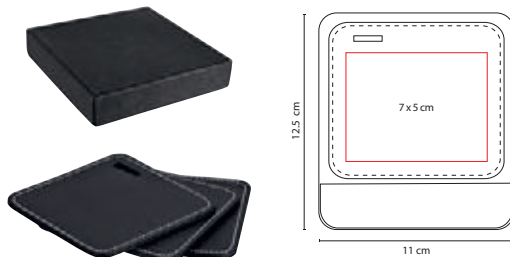

Incluye 4 portavasos.



■ BAR 001

PORTAVASOS **PORTER**

Material: Plástico / Metal
 Medida: 8.2 x 8.2 cm
 Área de Impresión: 4 x 4 cm
 Técnica de Impresión: Serigrafía
 Colores: Blanco
 Colores GTM: Blanco

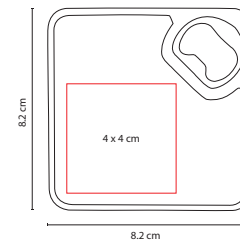

BASE ANTIDERRAPANTE

Portavasos con destapador.



■ KTC 090

DESTAPADOR **KAIA**

Material: Plástico
 Medida: 2.5 x 14 cm
 Área de Impresión: 1 x 6 cm
 Técnica de Impresión: Serigrafía
 Colores: Blanco
 Colores GTM: Blanco

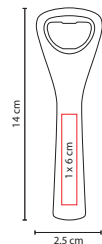



■ KTC 095

DESTAPADOR AKIL

Material: Plástico
 Medida: 8.6 x 4.5 cm
 Área de Impresión: 5 x 2 cm
 Técnica de Impresión: Serigrafía
 Colores: Blanco con Negro

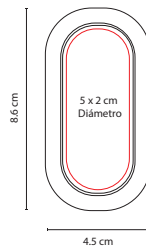

Destapador con imán.



■ 50700

DESTAPADOR EURE

Material: Metal
 Medida: 4.5 x 14.5 cm
 Área de Impresión: 2 cm Diámetro
 Técnica de Impresión: Láser
 Colores: Plata

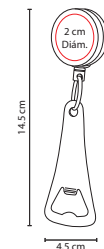

Destapador con cordón de alcance 75 cm y clip.



■ 60600

SACACORCHOS AUTOMÁTICO MALBEC

Material: Aluminio / Plástico
 Medida: 6.8 x 25.7 cm
 Área de Impresión: 3 x 6 cm
 Técnica de Impresión: Láser / Serigrafía
 Colores: Plata

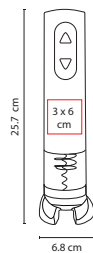

Sacacorchos automático recargable.
 Incluye adaptador de corriente.



■ 90300

SACACORCHOS IRINA

Material: Acero Inoxidable
 Medida: 3 x 12 cm
 Área de Impresión: 1 x 3 cm
 Técnica de Impresión: Láser / Serigrafía
 Colores: Negro

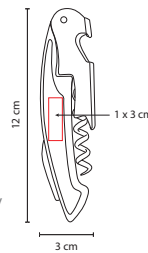

Incluye sacacorchos, navaja y destapador.



■ 90100

SACACORCHOS EYLAU

Material: Plástico
 Medida: 2 x 11 cm
 Área de Impresión: 1 x 5 cm
 Técnica de Impresión: Serigrafía
 Colores: Blanco



Sacacorchos armable.





87200

LICORERA BRISTOL

Material: Acero Inoxidable / Curpiel
 Medida: 10 x 12.5 cm Licorera / 3.6 x 4 cm Vasos
 Área de Impresión: 7 x 7 cm Licorera /
 2.2 x 1.7 cm Vasos
 Técnica de Impresión: Láser / Serigrafía /
 Tampografía / Termograbado
 Capacidad: 196 ml
 Colores: Negro

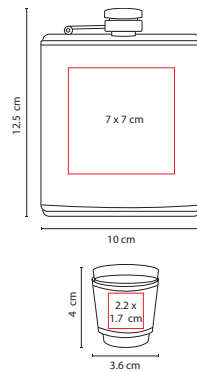

Incluye licorera, 2 vasos metálicos, embudo y caja de regalo.



60300

LICORERA JEBEL

Material: Acero Inoxidable / Curpiel
 Medida: 10 x 12.5 cm
 Área de Impresión: 7 x 7 cm
 Técnica de Impresión: Láser
 Capacidad: 196 ml
 Colores: Café

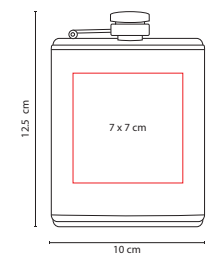

Incluye caja negra de regalo.



■ 60400

LICORERA TOSCANA

Material: Acero Inoxidable / Curpiel
 Medida: 10 x 12.5 cm
 Área de Impresión: 7 x 7 cm
 Técnica de Impresión: Láser
 Capacidad: 196 ml
 Colores: Negro

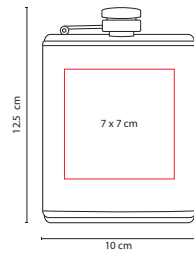

Incluye caja negra de regalo.



■ BAR 003

SET PARA VINOS ARENI

Material: Metal
 Medida: 17 x 11 cm
 Área de Impresión: 10 x 7 cm
 Técnica de Impresión: Pantógrafo / Serigrafía
 Colores: Plata

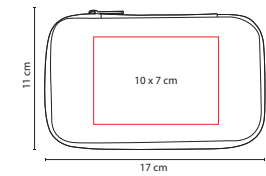

BOQUILLA



SACACORCHOS
CON NAVAJA



ARILLO



Estuche con boquilla, arillo y sacacorchos con navaja.



■ 851091

SET PARA VINOS **MEDITERRÁNEO**

Material: Madera / Metal

Medida: 14.5 x 17.5 cm

Área de Impresión: 13.5 x 16.5 cm

Técnica de Impresión: Láser / Serigrafía

Colores: Café

Colores GTM: Café

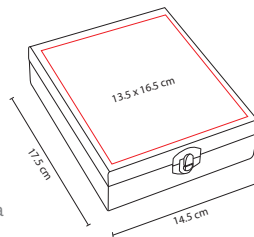

CORTADOR



SACACORCHOS
CON NAVAJA



ARILLO



STOPPER



TERMÓMETRO

Incluye sacacorchos con navaja, stopper, arillo, termómetro y cortador.



■ BAR 002

ESTUCHE PARA VINOS **GODELLO**

Material: Madera

Medida: 37.5 x 16 cm

Área de Impresión: 16 x 7 cm

Técnica de Impresión: Láser / Serigrafía

Colores: Beige

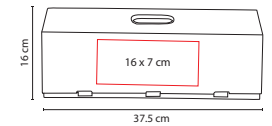

Espacio para una botella. Estuche con función de charola de servicio.



■ 60900

ESTUCHE PARA VINOS **BARONI**

Material: Cartón
 Medida: 10 x 36 cm
 Área de Impresión: 7 x 30 cm
 Técnica de Impresión: Termocalca
 Colores: Negro

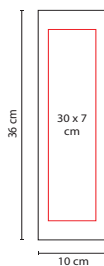

Estuche plegable con imán para una botella.



■ BAR 004

BASE PARA VINOS **LOUDI**

Material: Madera
 Medida: 40 x 10.9 cm
 Área de Impresión: 9 x 32 cm
 Técnica de Impresión: Láser / Serigrafía
 Colores: Beige

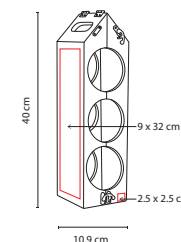

Espacio para una botella. Con función de portabotellas.



86300

ESTUCHE PARA VINOS **MOLORI**

Material: Curpiel
 Medida: 10 x 41 x 10.5 cm
 Área de Impresión: 5 x 9 cm
 Técnica de Impresión: Láser / Serigrafía
 Colores: Negro

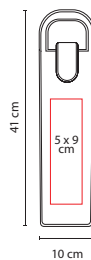

Bolsa curpiel porta botellas con broche metálico imantado.



86400

ESTUCHE PARA VINOS **PALERMO**

Material: Yute
 Medida: 11 x 35 x 9.5 cm
 Área de Impresión: 8.5 x 28 cm
 Técnica de Impresión: Serigrafía
 Colores: Blanco con Beige
 Colores GTM: Blanco con Beige

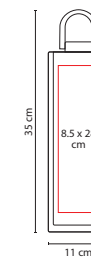

Interior plastificado. Agarraderas de madera.



■ **98641**

SET PARA VINOS **PAMPLONA**

Material: Curpiel / Metal / Terciopelo
 Medida: 37.5 x 12.7 cm
 Área de Impresión: 11.5 x 4.5 cm
 Técnica de Impresión: Láser / Serigrafía
 Colores: Café

■ ■ Colores GTM: Café

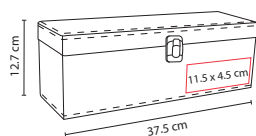

SACACORCHOS
CON NAVAJA



BOQUILLA



STOPPER



ARILLO



Incluye sacacorchos con navaja, stopper, boquilla y arillo. No incluye botella.



■ **851056**

SET PARA VINOS **CABERNET**

Material: Madera / Metal
 Medida: 36.5 x 11.8 cm
 Área de Impresión: 35 x 10 cm
 Técnica de Impresión: Láser / Serigrafía
 Colores: Negro

■ ■ Colores GTM: Negro

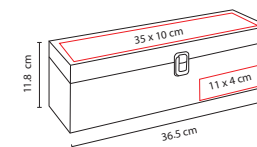

SACACORCHOS
CON NAVAJA



BOQUILLA



STOPPER



ARILLO



Incluye sacacorchos con navaja, stopper, boquilla y arillo.



851070

SET PARA VINOS **JUBA**

Material: Madera / Metal

Medida: 11.4 x 36 cm

Área de Impresión: 2 x 12 cm

Técnica de Impresión: Láser / Serigrafía

Colores: Negro

Colores GTM: Negro

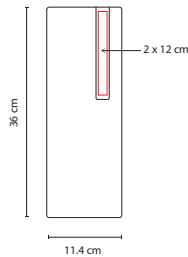

SACACORCHOS CON NAVAJA



ARILLO



STOPPER



BOQUILLA



98509

SET PARA VINOS **CHATEAU BLANC**

Material: Curpiel / Metal

Medida: 35.5 x 13 cm

Área de Impresión: 9.5 x 6.5 cm

Técnica de Impresión: Láser / Serigrafía

Colores: Negro

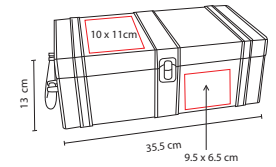

ARILLO



BOQUILLA



SACACORCHOS CON NAVAJA



TERMÓMETRO



Espacio para botella y dos copas (no incluidas) de 8 x 16 cm con sujetadores. Incluye sacacorchos con navaja, termómetro, boquilla y arillo.

RELOJES



■ MK 850

RELOJ KERRY

Material: Madera / Plástico
Medida: 9 x 14.5 cm
Área de Impresión: 6 x 3 cm
Técnica de Impresión: Láser
Colores: Café

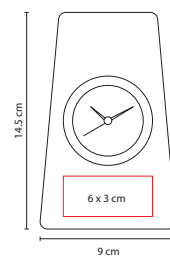

Incluye 1 batería de botón.

HOGAR



RELOJES DE ESCRITORIO



448



■ MK 250

RELOJ VON NEWMAN

Material: Aluminio / Plástico Imitación Madera

Medida: 19.5 x 11 cm

Área de Impresión: 16 x 3 cm

Técnica de Impresión: Serigrafía

Colores: Café

Colores GTM: Café

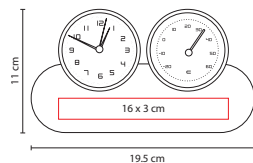

Funciones: reloj, alarma y termómetro. Batería (1 pila AA) incluida.



■ MK 120

RELOJ TIME CUBE

Material: Madera

Medida: 6.2 x 6.2 cm

Área de Impresión: 5 x 5 cm

Técnica de Impresión: Serigrafía

Colores: Beige

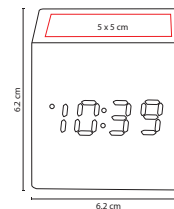

Reloj de madera con LED. Funciones: hora, alarma (se pueden programar 3 alarmas), calendario y temperatura. Baterías (3 pilas AAA) no incluidas. Incluye caja individual.



■ MK 400

RELOJ LONDON

Material: Plástico

Medida: 28 cm Diámetro

Área de Impresión: 20 cm Diámetro

Técnica de Impresión: Serigrafía

Colores: Plata

Colores GTM: Plata

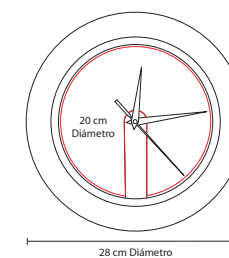

Amplia área de impresión. Venta de kit listo para armar e imprimir. Batería (1 pila AA) no incluida.



R

■ MK 110

RELOJ ZEIT

Material: Plástico
 Medida: 30.5 cm Diámetro
 Área de Impresión: 12 x 4 cm
 Técnica de Impresión: Serigrafía
 Colores: A/B/R

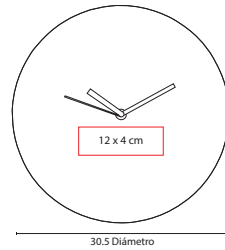

Amplia área de impresión. Venta de kit listo para armar e imprimir.
 Batería (1 pila AA) no incluida. Incluye caja individual.



N

■ MK 500

RELOJ OSSIAN

Material: Aluminio / Plástico
 Medida: 30.5 cm Diámetro
 Área de Impresión: 9 x 2.5 cm
 Técnica de Impresión: Láser / Serigrafía
 Colores: B/N
 ■ ■ Colores GTM: B/N

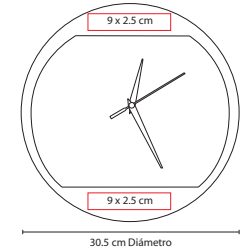

Batería (1 pila AA) no incluida.

PORTARRETRATOS



■ PRT 080

PORTARRETRATO MINI CAPRI

Material: Aluminio No Galvanizado

Medida: 10.4 x 8.1 cm

Área de Impresión: 7 x 1 cm

Técnica de Impresión: Pantógrafo / Serigrafía

Colores: Plata

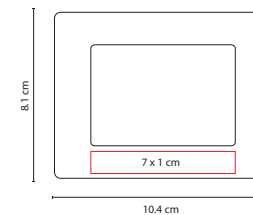

COMPARATIVO
PRT 080 Y PRT 090

2 Posiciones: horizontal y vertical. Tamaño de la foto 6 x 8 cm.



■ PRT 060

PORTARRETRATO SUITE 1

Material: Aluminio No Galvanizado

Medida: 6.5 x 14.8 cm

Área de Impresión: 5 x 5 cm

Técnica de Impresión: Pantógrafo / Serigrafía

Colores: Plata

Colores GTM: Plata

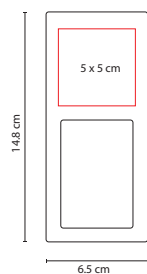

2 Posiciones: horizontal y vertical.
Tamaño de la foto 5 x 7.5 cm.



■ PRT 005

PORTARRETRATO PAGLIA

Material: Plástico

Medida: 22 x 17 cm

Área de Impresión: 7 x 2 cm

Técnica de Impresión: Serigrafía

Colores: Blanco

Colores GTM: Blanco

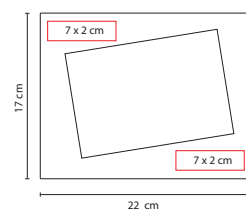

2 Posiciones: horizontal y vertical.
Tamaño de la foto 15 x 10 cm.



■ PRT 090

PORTARRETRATO SAHURA

Material: Aluminio No Galvanizado

Medida: 18 x 13 cm

Área de Impresión: 12 x 1 cm

Técnica de Impresión: Pantógrafo / Serigrafía

Colores: Plata

Colores GTM: Plata

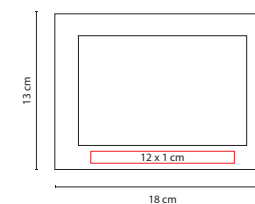

2 Posiciones: horizontal y vertical.
Tamaño de la foto 10 x 15 cm.



A

■ PRT 003

PORTARRETRATO **CINDREL**

Material: Plástico
 Medida: 17.5 x 17.5 cm
 Área de Impresión: 13 x 5 cm
 Técnica de Impresión: Serigrafía
 Colores: A/B/O/R/V
 Colores GTM: A/B/R

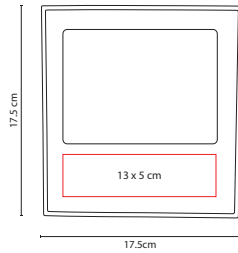

O



B



V



R

2 Posiciones: horizontal y vertical. Tamaño de la foto 13.5 x 8.5 cm.



■ PRT 350

PORTARRETRATO **EMOTION**

Material: Aluminio No Galvanizado
 Medida: 16 x 16 cm
 Área de Impresión: 13 x 3.5 cm
 Técnica de Impresión: Láser / Serigrafía
 Colores: Plata

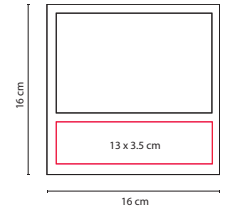

2 Posiciones: horizontal y vertical. Tamaño de la foto 10 x 15 cm.



■ PRT 008

PORTARRETRATO GIRABLE **TUAREG**

Material: Aluminio
Medida: 21 x 15 cm

Área de Impresión: 10 x 3 cm

Técnica de Impresión: Pantógrafo / Serigrafía
Colores: Plata

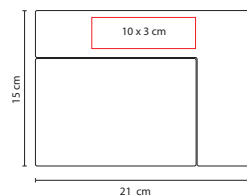

Posición horizontal para 2 fotos, frente y vuelta. Tamaño de la foto 15 x 10 cm.



■ PRT 001

PORTARRETRATO **LIVING**

Material: Aluminio No Galvanizado
Medida: 15.5 x 17.5 cm

Área de Impresión: 13 x 2.5 cm

Técnica de Impresión: Pantógrafo / Serigrafía
Colores: Plata

■ ■ Colores GTM: Plata

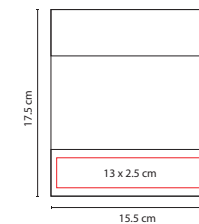

2 Posiciones: horizontal y vertical. Tamaño de la foto 10 x 15 cm.



■ PRT 002

PORTARRETRATO **URBEL**

Material: Aluminio
Medida: 23 x 15 cm

Área de Impresión: 4 x 4 cm

Técnica de Impresión: Pantógrafo / Serigrafía
Colores: Plata

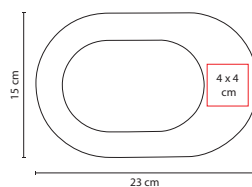

Posición horizontal. Tamaño de la foto 15 x 10 cm.



■ PRT 004

PORTARRETRATO **ALBALI**

Material: Aluminio
Medida: 17 cm Diámetro

Área de Impresión: 3 x 2.5 cm

Técnica de Impresión: Pantógrafo / Serigrafía
Colores: Plata

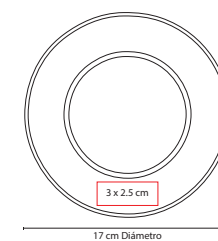

Tamaño de la foto 10 x 10 cm.



■ PRT 400

PORTARRETRATO RELOJ **MEDIA LUNA**

Material: Plástico

Medida: 16.2 x 14.3 cm

Área de Impresión: 2 x 10 cm

Técnica de Impresión: Serigrafía

Colores: Plata

Colores GTM: Plata

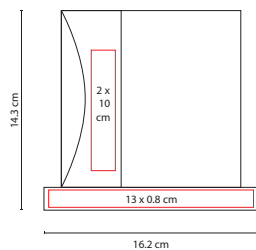

Tamaño de la foto 9 x 13 cm. Incluye 1 batería de botón.



■ PRT 500

PORTARRETRATO **HOPE**

Material: Plástico

Medida: 17.9 x 17.9 cm

Área de Impresión: 5.5 x 8 cm

Técnica de Impresión: Serigrafía

Colores: Plata

Colores GTM: Plata

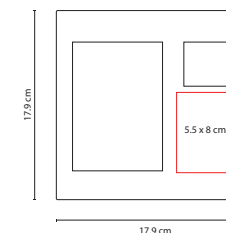

Portarretrato con calendario y reloj. Tamaño de la foto 9 x 13 cm. Baterías (2 pilas AAA) no incluidas.



■ PRT 010

PORTARRETRATO **DEVON**

Material: Curpiel
Medida: 16 x 21 cm

Área de Impresión: 12 x 1,5 cm

Técnica de Impresión: Láser / Serigrafía
Colores: Café

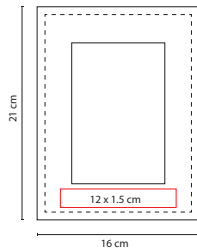

2 Posiciones: horizontal y vertical. Tamaño de la foto 10 x 15 cm.



■ PRT 006

PORTARRETRATO **BARSEI**

Material: Yute
Medida: 23 x 15 cm

Área de Impresión: 4 x 11 cm

Técnica de Impresión: Serigrafía
Colores: Café

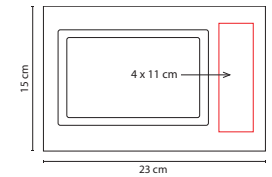

2 Posiciones: horizontal y vertical. Tamaño de la foto 14 x 9 cm.



■ PRT 018

PORTARRETRATO **AREZZO**

Material: Madera
 Medida: 18 x 20 cm
 Área de Impresión: 13 x 2 cm
 Técnica de Impresión: Láser / Serigrafía
 Colores: Café

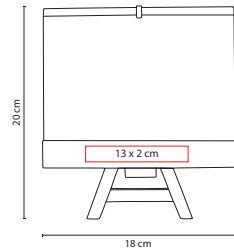

Tamaño de la foto 18 x 12.5 cm.



■ PRT 007

PORTARRETRATO **NEMIRA**

Material: MDF
 Medida: 15 x 20 cm
 Área de Impresión: 9 x 2.2 cm
 Técnica de Impresión: Serigrafía
 Colores: Beige

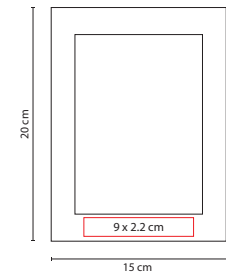

2 Posiciones: horizontal y vertical. Tamaño de la foto 9 x 13.5 cm.



M A S C O T A S



A

■ PET 002

DISCO VOLADOR LAIKA

Material: Poliéster

Medida: 20 cm Diámetro

Área de Impresión: 7 x 7 cm

Técnica de Impresión: Bordado / Serigrafía

Colores: A/N/R

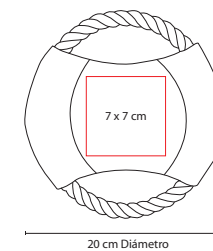

R



N

Disco volador de cuerda para perro.



■ PET 001

DISPENSADOR **BONE**

Material: Plástico
Medida: 8.1 x 4.4 cm
Área de Impresión: 2 x 2.5 cm
Técnica de Impresión: Serigrafía
Colores: Blanco

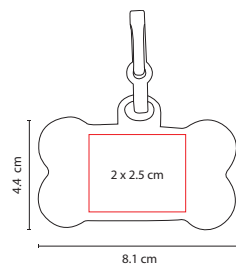

Incluye 20 bolsas de plástico y gancho.



■ PET 005

PLATO **MEALTIME**

Material: Plástico
Medida: 21.5 cm Diámetro
Área de Impresión: 16 x 3 cm
Técnica de Impresión: Serigrafía
Capacidad: 600 ml
Colores: Blanco

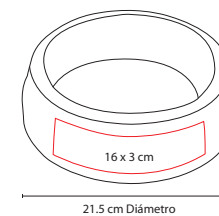

Plato para mascotas.





R

■ PET 007

KIT MASCOTA ZULLY

Material: Plástico
 Medida: 15.5 x 32 cm
 Área de Impresión: 10 x 10 cm
 Técnica de Impresión: Serigrafía
 Capacidad: 700 ml Plato / 1 Galón Contenedor
 Colores: A/B/R

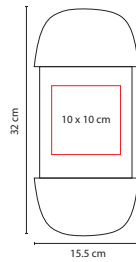

B



A

Contenedor portátil con dos platos.



A

■ PET 003

CORREA HIKE

Material: Poliéster / Metal
 Medida: 2 x 120 cm
 Área de Impresión: 1.5 x 90 cm
 Técnica de Impresión: Bordado / Serigrafía
 Colores: A/N/R

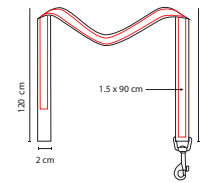

R



N

Correa con broche metálico.

BIENESTAR





SALUD

■ SLD 009

PORTA GAFETE DOCTOR

Material: Plástico
 Medida: 4 x 9.7 cm
 Área de Impresión: 2.3 x 1.2 cm
 Técnica de Impresión: Serigrafía / Tampografía
 Colores: Blanco

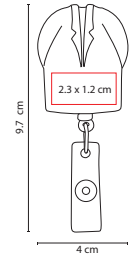

Cordón 80 cm. Incluye clip porta tarjetas.

■ SLD 005

PORTA PLUMAS DOCTOR

Material: Plástico / Metal
 Medida: 4.9 x 7 cm
 Área de Impresión: 2.3 x 1.2 cm
 Técnica de Impresión: Serigrafía / Tampografía
 Colores: Blanco

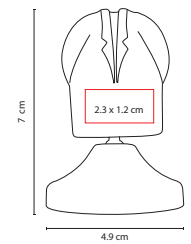

Porta pluma con pisa papeles. No incluye bolígrafo.



■ HL 170

LIBRETA **DOCTOR**

Material: Cartón / Espiral Metálico
 Medida: 17.2 x 21.5 cm
 Área de Impresión: 4.5 x 8 cm
 Técnica de Impresión: Serigrafía
 Colores: Blanco

☑ Colores GTM: Blanco

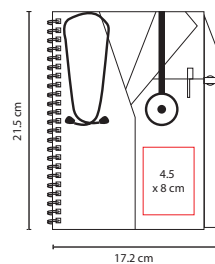

100 Hojas de raya. Con elástico para bolígrafo.
 No incluye bolígrafo.



■ SLD 010

DESPACHADOR DE NOTAS **DOCTOR**

Material: Plástico
 Medida: 8 x 11.7 cm
 Área de Impresión: 4 x 2 cm
 Técnica de Impresión: Serigrafía / Tampografía
 Colores: Blanco

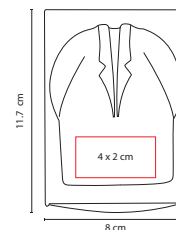

Incluye 40 hojas de notas.



■ SLD 011

FUNDA PROTECTORA **CASSIA**

Material: Plástico
 Medida: 8 x 14.5 cm
 Área de Impresión: 6 x 6 cm
 Técnica de Impresión: Serigrafía
 Colores: Blanco

☑ Colores GTM: Blanco

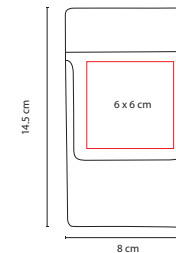

Funda protectora para bolígrafos y tarjetas.
 Bolígrafos no incluidos.





PT 588

VASO PASTILLERO

Material: Plástico
 Medida: 7.2 cm Diámetro
 Área de Impresión: 6 cm Diámetro
 Técnica de Impresión: Serigrafía
 Colores: Blanco
 Colores GTM: Blanco

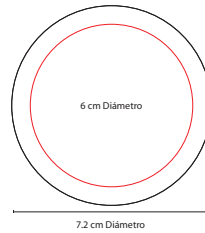

Pastillero con tapa y vaso retráctil.



PT 015

PASTILLERO LURITJA

Material: Plástico
 Medida: 3.8 x 5.9 cm
 Área de Impresión: 3 x 3 cm
 Técnica de Impresión: Serigrafía
 Colores: A/B/R

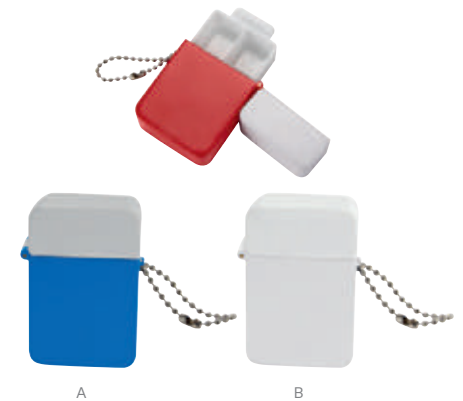
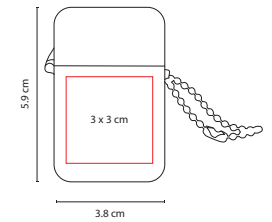

2 Compartimentos.



PT 0942

PASTILLERO **FROSTY**

Material: Plástico
Medida: 9.7 x 6.4 cm
Área de Impresión: 6.3 x 3.9 cm
Técnica de Impresión: Serigrafía
Colores: Blanco Frosty
Colores GTM: Blanco Frosty

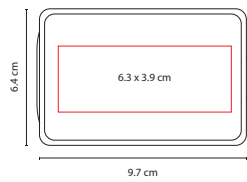

10 Compartimentos.



PT 050

PASTILLERO **PÍLDORA**

Material: Plástico
Medida: 6.4 cm Diámetro
Área de Impresión: 3 x 1.5 cm
Técnica de Impresión: Serigrafía
Colores: Blanco
Colores GTM: Blanco

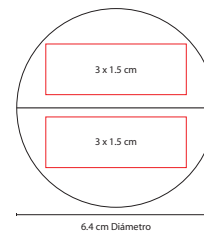

4 Compartimentos.



PT 200

PASTILLERO **AMBAÍ**

Material: Plástico
Medida: 6 x 3.8 cm
Área de Impresión: 4.3 x 2.7 cm
Técnica de Impresión: Serigrafía
Colores: Blanco Frosty
Colores GTM: Blanco Frosty

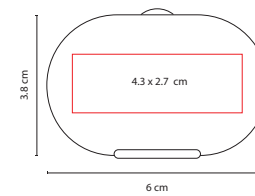

3 Compartimentos.





■ PT 2167

PASTILLERO SAO

Material: Plástico
 Medida: 6 x 6 cm
 Área de Impresión: 2 x 2 cm
 Técnica de Impresión: Serigrafía
 Colores: Blanco Frosty

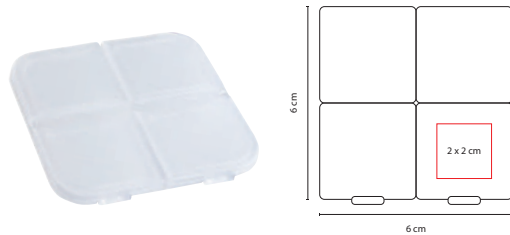

4 Compartimentos.



R

■ PT 100

PASTILLERO GAMMA

Material: Plástico
 Medida: 7 cm Diámetro
 Área de Impresión: 4.5 cm Diámetro
 Técnica de Impresión: Serigrafía
 Colores: A/N/R

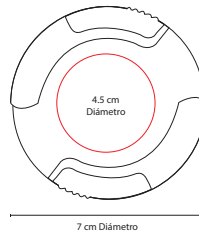

A



N

2 Compartimentos.



■ PT 2164

PASTILLERO JANS

Material: Plástico
 Medida: 9.5 x 4.7 cm
 Área de Impresión: 4.8 x 3.2 cm
 Técnica de Impresión: Serigrafía
 Colores: Blanco
 Colores GTM: Blanco

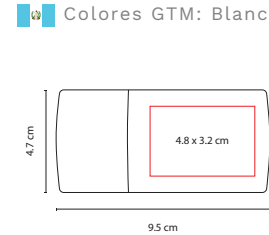

Pastillero con corta pastillas y 2 compartimentos separables.



PT 400

PASTILLERO **EVER**

Material: Plástico
 Medida: 8.5 x 4 cm
 Área de Impresión: 2.5 x 2 cm
 Técnica de Impresión: Serigrafía
 Colores: Transparente
 Colores GTM: Transparente

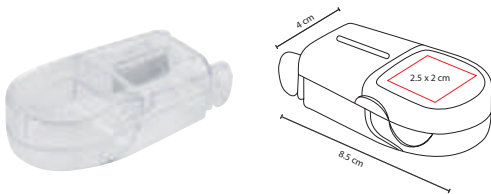

Con corta pastillas.



A

PT 2166

PASTILLERO **DELTA**

Material: Plástico
 Medida: 7 cm Diámetro
 Área de Impresión: 5 x 2.7 cm
 Técnica de Impresión: Serigrafía
 Colores: A/B/R
 Colores GTM: A/B/R

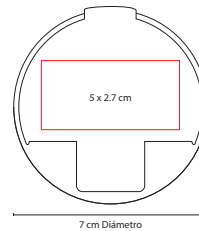

R

4 Compartimentos.



PT 2100

PASTILLERO **CRYSTAL**

Material: Plástico
 Medida: 8.5 x 4 cm
 Área de Impresión: 6 x 2.5 cm
 Técnica de Impresión: Serigrafía
 Colores: Blanco

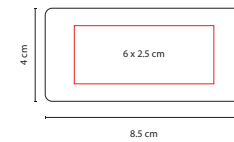

Pastillero con corta pastillas.





■ PT 017

PASTILLERO LLAVERO MALIAN

Material: Plástico
 Medida: 4.8 x 9.7 cm
 Área de Impresión: 2.7 cm Diámetro
 Técnica de Impresión: Serigrafía
 Colores: A/B/R

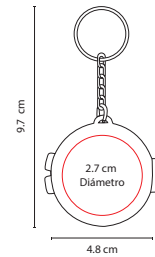

1 Compartimento.



■ PT 2362

PASTILLERO MENZEL

Material: Plástico
 Medida: 9 cm Diámetro
 Área de Impresión: 5 cm Diámetro
 Técnica de Impresión: Serigrafía / Tampografía
 Colores: Blanco Frosty

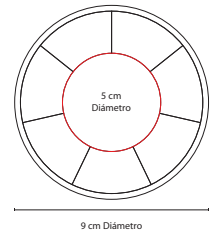

7 Compartimentos para cada día de la semana.



■ DAM 019

KIT DE BAÑO **ALTHEA**

Material: Plástico / Poliéster
 Medida: 18 x 14.5 cm
 Área de Impresión: 8 x 6 cm
 Técnica de Impresión: Serigrafía
 Colores: Blanco

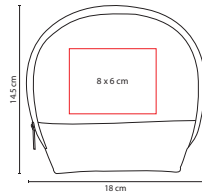

Incluye 4 accesorios de baño: 2 esponjas, cepillo y guante.



■ SLD 008

GEL ANTIBACTERIAL **HELDER**

Material: Plástico / Silicón
 Medida: 3.5 x 12.8 cm
 Área de Impresión: 1.8 x 3.7 cm
 Técnica de Impresión: Serigrafía / Tampografía
 Capacidad: 30 ml
 Colores: A/B/R/O/P/V

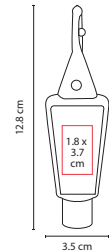

Gel antibacteriano portátil y recargable. Incluye sujetador de silicón.





A

■ SLD 030

GEL ANTIBACTERIAL **IMANPA**

Material: Plástico / Silicón

Medida: 4.2 x 12.5 cm

Área de Impresión: 2 x 2 cm

Técnica de Impresión: Serigrafía / Tampografía

Capacidad: 30 ml

Colores: A/B/R

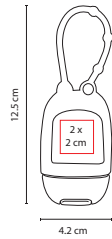

R



B

Gel antibacterial. Portátil y recargable. Incluye sujetador de silicón.



R

■ SLD 021

GEL ANTIBACTERIAL **ONSELLA**

Material: Plástico / Silicón

Medida: 4.8 x 11.9 cm

Área de Impresión: 3 x 3 cm

Técnica de Impresión: Serigrafía / Tampografía

Capacidad: 40 ml

Colores: A/B/R

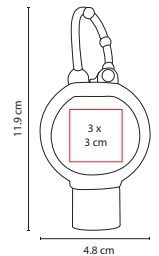

B



A

Gel antibacterial. Portátil y recargable. Incluye sujetador de silicón.



B

■ SLD 026

ANTIBACTERIAL LISTER

Material: Plástico
 Medida: 6 x 8 cm
 Área de Impresión: 4.2 x 6 cm
 Técnica de Impresión: Serigrafía
 Capacidad: 20 ml
 Colores: A/B/R

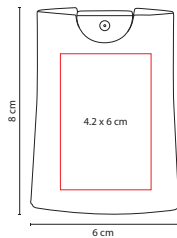

A



R

Incluye líquido antibacterial con atomizador. Aroma cítrico.



■ SLD 019

ANTIBACTERIAL LECCE

Material: Plástico
 Medida: 2.5 x 11 cm
 Área de Impresión: 2 x 3 cm
 Técnica de Impresión: Serigrafía
 Capacidad: 30 ml
 Colores: Transparente

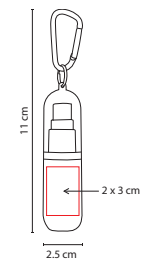

Incluye líquido antibacterial con atomizador y carabina en la tapa. Aroma cítrico.





■ SLD 016

TOALLITAS NURE

Material: Plástico
 Medida: 2.5 x 10.8 cm
 Área de Impresión: 1.5 x 8 cm
 Técnica de Impresión: Serigrafía
 Colores: Blanco



Contiene 10 toallas comprimidas de 22 x 24 cm c/u.
 Se expanden al agregar un poco de agua.



G

■ SLD 018

ANTIBACTERIAL ZANTE

Material: Plástico
 Medida: 2.8 x 10.5 cm
 Área de Impresión: 1.5 x 4 cm
 Técnica de Impresión: Serigrafía
 Capacidad: 30 ml
 Colores: A/G/R

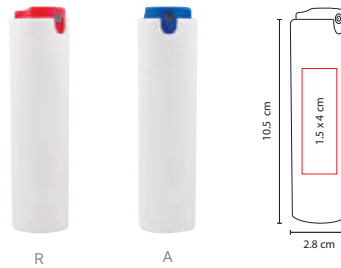

R

A



Incluye líquido antibacteriano con atomizador. Aroma cítrico.



■ SLD 022

LÁMINAS DE JABÓN AINSA

Material: Plástico
 Medida: 4.7 x 7 cm
 Área de Impresión: 3.5 x 2.5 cm
 Técnica de Impresión: Serigrafía
 Capacidad: 2 g
 Colores: Blanco



Hojas de jabón en estuche. Agregar un poco de agua para su uso.



A

■ SLD 002

TOALLITAS SALVIA

Material: Plástico

Medida: 4.8 x 8.4 cm

Área de Impresión: 3.5 x 4 cm

Técnica de Impresión: Tampografía

Colores: A/B/R/V

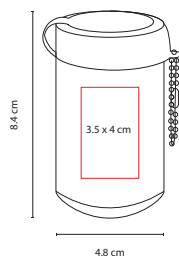

B



R



V

Contiene 30 toallitas húmedas. Incluye cadena metálica.



■ SLD 031

TOALLAS FINKE

Material: Plástico

Medida: 12.7 x 7.5 cm

Área de Impresión: 4 x 3 cm

Técnica de Impresión: Tampografía

Colores: Gris

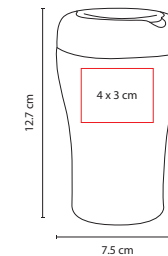

Contiene 25 toallitas húmedas.





■ SLD 020

REPELENTE DE MOSQUITOS

Material: Plástico
 Medida: 1.8 x 10 cm
 Área de Impresión: 0.8 x 4 cm
 Técnica de Impresión: Serigrafía
 Capacidad: 16 ml
 Colores: Transparente

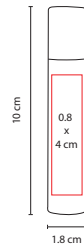

Repelente de mosquitos con más 3 horas de efecto. No aplicar directo a la cara.

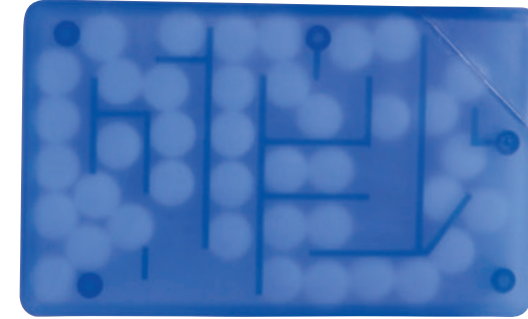

A

■ MNT 001

MENTAS FRESH

Material: Plástico
 Medida: 7.9 x 4.8 cm
 Área de Impresión: 5 x 3.5 cm
 Técnica de Impresión: Serigrafía
 Capacidad: 6.5 g
 Colores: A/B/R

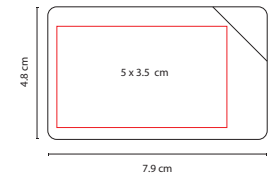

B



R

Contiene 6.5 g de pastillas de menta. Estuche con laberinto interior.



■ SLD 003

CEPILLO PORTÁTIL MINT

Material: Plástico
Medida: 2.2 x 15.8 cm
Área de Impresión: 1.5 x 6.3 cm
Técnica de Impresión: Serigrafía
Colores: Transparente
■ ■ Colores GTM: Transparente

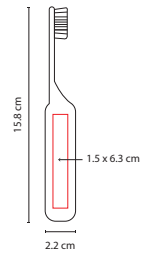

Cepillo portátil. Estuche en la base del cepillo.



■ SLD 032

CEPILLO LHOTSE

Material: Plástico
Medida: 16 x 2.1 cm
Área de Impresión: 0.8 x 1.8 cm / .5 x 2.5 cm
Técnica de Impresión: Serigrafía
Colores: Blanco

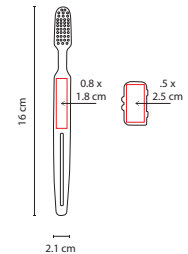

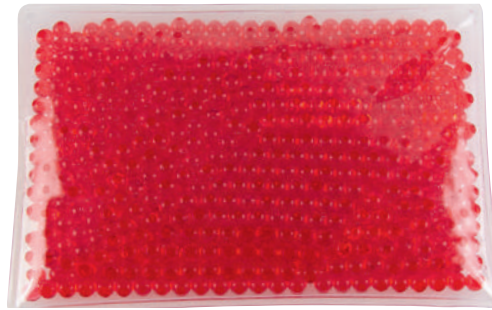

R

■ SLD 015

COMPRESA DE GEL

Material: PVC / Gel
 Medida: 14 x 10 cm
 Área de Impresión: 10 x 6 cm
 Técnica de Impresión: Serigrafía
 Colores: A/B/R

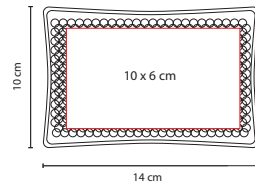

B



A



Compresa con micro esferas de gel frío/caliente.

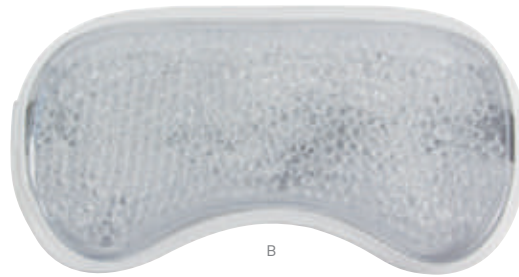

B

■ SLD 027

ANTIFAZ THERAPIE

Material: Plástico
 Medida: 21 x 10.5 cm
 Área de Impresión: 13 x 6 cm
 Técnica de Impresión: Serigrafía
 Colores: A/B

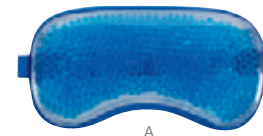
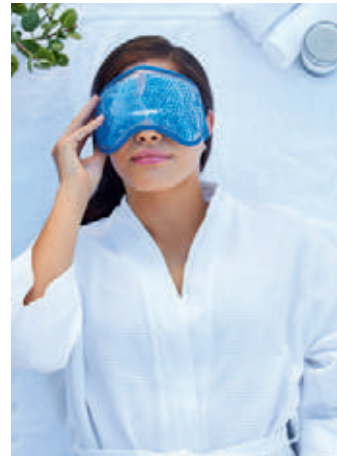
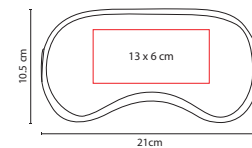

A



Compresa antifaz con micro esferas de gel frío/caliente.



A

■ SLD 023

BÁLSAMO LABIAL KAITSE

Material: Plástico
 Medida: 1.9 x 6.9 cm
 Área de Impresión: 1 x 2.5 cm
 Técnica de Impresión: Tampografía
 Capacidad: 4.5 g
 Colores: A/R

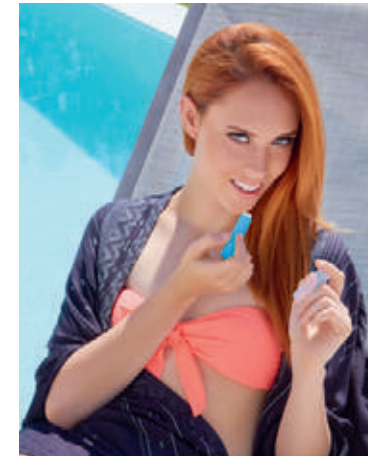
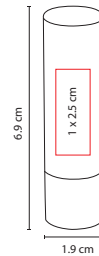

R

Bálsamo labial en tubo con tapa translúcida.



■ KIT 911

KIT ANTIBACTERIAL

Material: Plástico
Medida: 20 x 14.5 cm

Área de Impresión: 12 x 5 cm
Técnica de Impresión: Serigrafía
Colores: Blanco Frosty

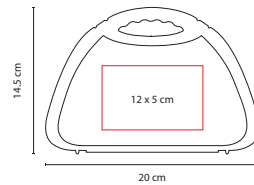

Incluye gel antibacterial de 60 mL, 1 cubre boca, 2 gasas, 3 curitas, 20 cotonetes, 1 mertodol de 40 mL y estuche de plástico.



■ SLD 029

TORNIQUETE ARUMBERA

Material: Poliéster / Plástico
Medida: 38 x 3 cm

Área de Impresión: 1.5 x 1 cm
Técnica de Impresión: Serigrafía
Colores: A/G

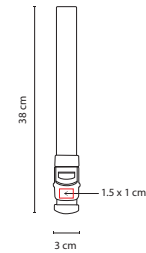

G

Torniquete elástico ajustable con hebilla de liberación.





■ SLD 028

BÁSCULA **FINISH**

Material: Cristal
 Medida: 32.8 cm Diámetro
 Área de Impresión: 16 x 10 cm
 Técnica de Impresión: Serigrafía
 Colores: Transparente

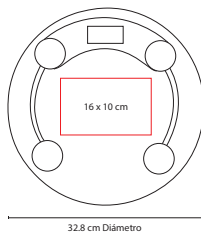

Báscula digital. Capacidad máxima 180 kg.
 Batería (1 de botón) incluida.

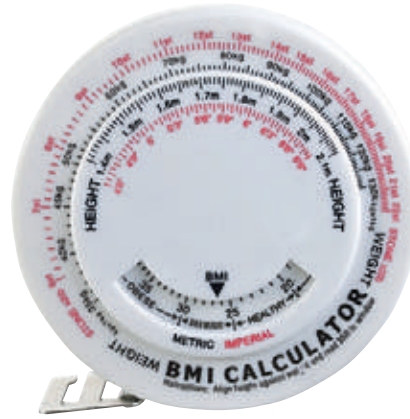

■ SLD 006

CINTA MASA CORPORAL **SLIM**

Material: Plástico
 Medida: 7.2 cm Diámetro
 Área de Impresión: 2.5 x 1.5 cm
 Técnica de Impresión: Serigrafía
 Colores: Blanco
 Colores GTM: Blanco

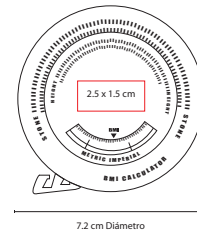

Cinta medidora de masa corporal. 150 cm de longitud.



■ SLD 024

MINI LENTES **CLIP READ**

Material: Plástico
 Medida: 8.9 x 5.5 cm Funda / 9.1 x 3 cm Lentes
 Área de Impresión: 7 x 4 cm
 Técnica de Impresión: Serigrafía
 Colores: Blanco

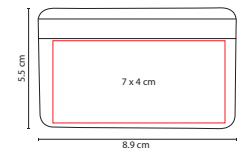

REVERSO CON ADHESIVO



Mini lentes portátiles con aumento de 2.5. Incluye funda.

ANTI-STRESS



■ SOC 013

PELOTA ANTI-STRESS LISA

Material: PU

Medida: 6 cm Diámetro

Área de Impresión: 4.7 cm Diámetro

Técnica de Impresión: Tampografía

Colores: A/B/N/O/P/R/S/V/Y

Colores GTM: A/O/P/R/S/V/Y

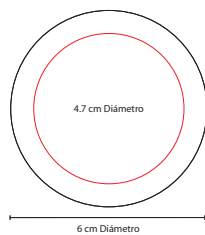

P

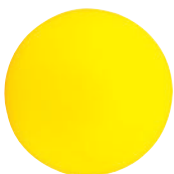

Y



A



B



S



V



O



N



R





V

■ SOC 067

CUBO LISO ANTI-STRESS

Material: PU

Medida: 5 x 5 cm

Área de Impresión: 4 x 4 cm

Técnica de Impresión: Tampografía / Serigrafía

Colores: A/O/R/V

Colores GTM: A/R/V

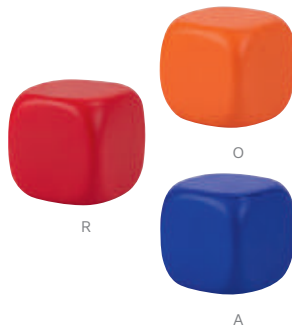
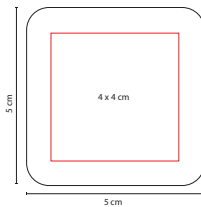

R

O

A



■ SOC 910

PELOTA ANTI-STRESS COLORFUL

Material: PU

Medida: 6.3 cm Diámetro

Área de Impresión: 3 cm Diámetro

Técnica de Impresión: Tampografía

Colores: Multicolor

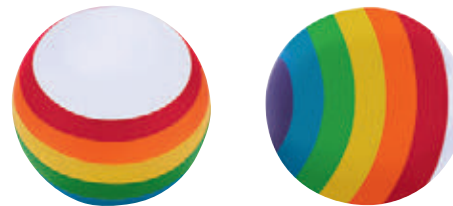
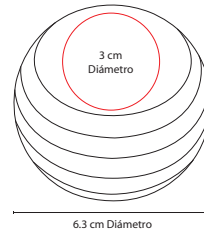

■ SOC 013 W

MUNDO PELOTA ANTI-STRESS

Material: PU

Medida: 6.4 cm Diámetro

Área de Impresión: 4.7 cm Diámetro

Técnica de Impresión: Tampografía

Colores: Azul con Verde

Colores GTM: Azul con Verde

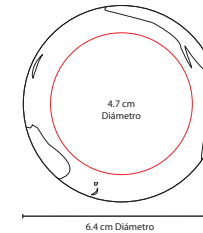



■ SOC 011-09

CORAZÓN ANTI-STRESS

Material: PU
Medida: 7.3 x 6.7 cm
Área de Impresión: 4.5 x 4 cm
Técnica de Impresión: Tampografía
Colores: Rojo
■ ■ Colores GTM: Rojo

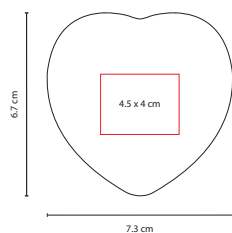

■ SOC 011-07

CARITA FELIZ ANTI-STRESS

Material: PU
Medida: 6 cm Diámetro
Área de Impresión: 5 cm Diámetro
Técnica de Impresión: Tampografía
Colores: Amarillo
■ ■ Colores GTM: Amarillo

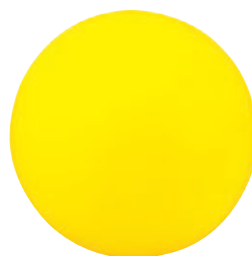
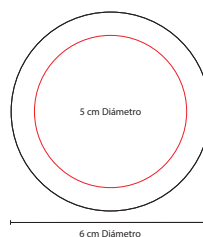

V

■ SOC 920

PELOTA ANTI-STRESS BEACH

Material: PU
Medida: 6.3 cm Diámetro
Área de Impresión: 3 x 1.5 cm
Técnica de Impresión: Tampografía
Colores: A/O/R/V

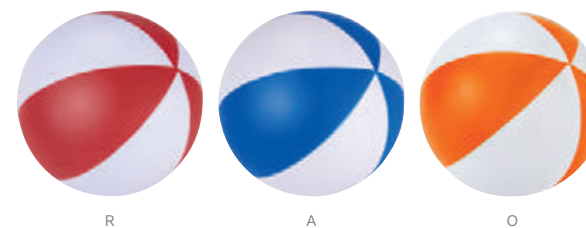
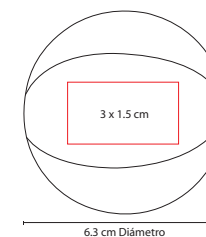

R

A

O





■ SOC 011-03

PELOTA ANTI-STRESS **GOLF**

Material: PU
 Medida: 6.2 cm Diámetro
 Área de Impresión: 4 cm Diámetro
 Técnica de Impresión: Tampografía
 Colores: Blanco
 Colores GTM: Blanco

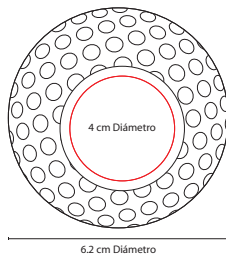

■ SOC 011-05

PELOTA ANTI-STRESS **BASEBALL**

Material: PU
 Medida: 6.2 cm Diámetro
 Área de Impresión: 2.5 cm Diámetro
 Técnica de Impresión: Tampografía
 Colores: Blanco con Rojo
 Colores GTM: Blanco con Rojo

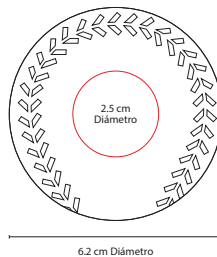

■ SOC 011-02

PELOTA ANTI-STRESS **BASKETBALL**

Material: PU
 Medida: 6.2 cm Diámetro
 Área de Impresión: 1.5 x 5 cm
 Técnica de Impresión: Tampografía
 Colores: Naranja con Negro

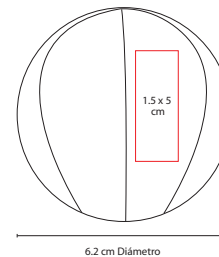

■ SOC 011-04

PELOTA ANTI-STRESS **TENNIS**

Material: PU
 Medida: 6.2 cm Diámetro
 Área de Impresión: 3.5 x 4 cm
 Técnica de Impresión: Tampografía
 Colores: Amarillo con Blanco
 Colores GTM: Amarillo con Blanco

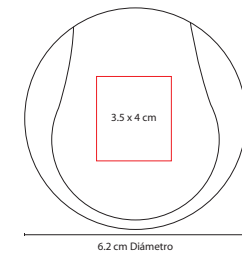



■ SOC 011-06

PELOTA ANTI-STRESS FÚTBOL AMERICANO

Material: PU
Medida: 9 x 6.2 cm
Área de Impresión: 3 x 3 cm
Técnica de Impresión: Tampografía
Colores: Café

■ Colores GTM: Café

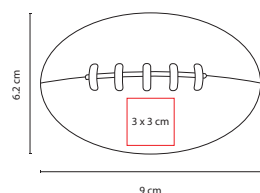

■ SOC 060

PELOTA ANTI-STRESS BALÓN

Material: PU / Plástico
Medida: 5.5 x 8.7 cm
Área de Impresión: 2 x 1 cm
Técnica de Impresión: Tampografía
Colores: Blanco con Negro

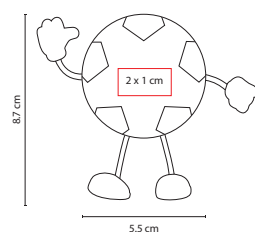

■ SOC 011-01

PELOTA ANTI-STRESS FÚTBOL

Material: PU
Medida: 6.2 cm Diámetro
Área de Impresión: 2 x 1 cm
Técnica de Impresión: Tampografía
Colores: Blanco con Negro

■ Colores GTM: Blanco con Negro

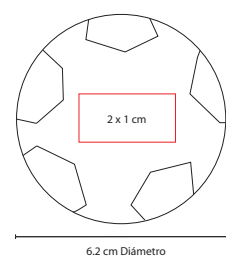

■ SOC 061

ANTI-STRESS CAMISETA

Material: PU
Medida: 8 x 9 cm
Área de Impresión: 4 x 5 cm
Técnica de Impresión: Tampografía
Colores: Blanco

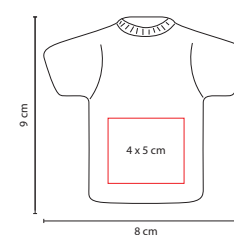



02
LICENCIADO

■ SOC 220

ANTI-STRESS OFICIOS

Material: PU
Medida: 7 x 10 cm
Área de Impresión: 3.5 x 1.5 cm
Técnica de Impresión: Tampografía
Colores: 01/02/03

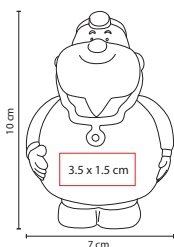

01
DOCTOR



03
OBRERO



■ SOC 066

DOCTOR ANTI-STRESS

Material: PU
Medida: 5 x 10 cm
Área de Impresión: 3 x 2 cm
Técnica de Impresión: Tampografía
Colores: Blanco

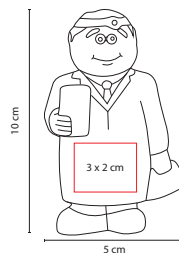

■ SOC 900

ANTI-STRESS WORK

Material: PU
Medida: 7 x 4.5 cm
Área de Impresión: 3 x 2 cm
Técnica de Impresión: Tampografía
Colores: Amarillo

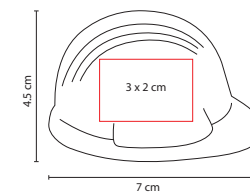



■ SOC 024

TRAILER ANTI-STRESS

Material: PU
 Medida: 15.2 x 4.1 cm
 Área de Impresión: 10.5 x 2.2 cm
 Técnica de Impresión: Serigrafía
 Colores: Blanco con Gris

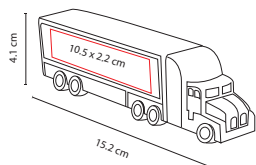

■ SOC 213

ANTI-STRESS BULLY

Material: PU
 Medida: 10.3 x 7 cm
 Área de Impresión: 5 x 2 cm
 Técnica de Impresión: Tampografía
 Colores: Negro

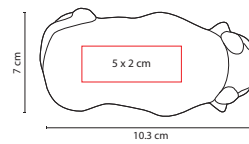

R

■ SOC 212

ANTI-STRESS OSITO RELAX

Material: PU
 Medida: 6.5 x 9.5 cm
 Área de Impresión: 3.5 x 2.5 cm
 Técnica de Impresión: Tampografía
 Colores: A/B/R

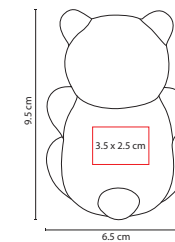

A



B





02



01

■ SOC 210

ANTI-STRESS ZOO

Material: PU

Medida: 5.6 x 6.4 cm Vaca / 5.8 x 5.5 cm Puerquito

Área de Impresión: 4 x 4 cm Vaca / 4 x 3 cm Puerquito

Técnica de Impresión: Tampografía

Colores: 01/02

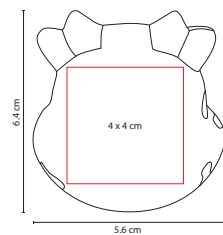
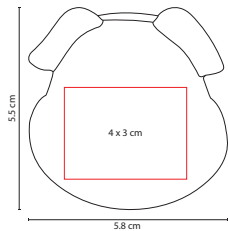

■ SOC 026

VAQUITA ANTI-STRESS

Material: PU

Medida: 12 x 6.5 cm

Área de Impresión: 4 x 2.5 cm

Técnica de Impresión: Tampografía

Colores: Blanco con Negro

Colores GTM: Blanco con Negro

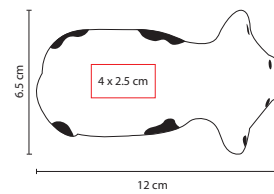

■ SOC 027

PUERQUITO ANTI-STRESS

Material: PU

Medida: 7.2 x 7 cm

Área de Impresión: 3.6 x 3.6 cm

Técnica de Impresión: Tampografía

Colores: Rosa

Colores GTM: Rosa

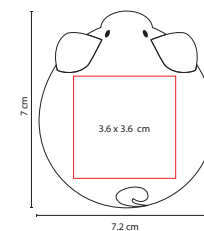



■ SOC 028

ANTI-STRESS WIT

Material: PU
Medida: 8.3 x 6.5 cm
Área de Impresión: 6.5 x 3.2 cm
Técnica de Impresión: Serigrafía
Colores: Blanco con Negro

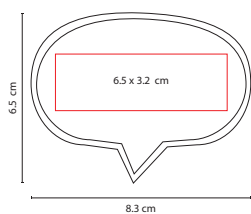

Anti-stress en forma de globo de idea.



■ SOC 029

CUBO MULTICOLOR ANTI-STRESS

Material: PU
Medida: 5.5 x 5.5 cm
Área de Impresión: 4.8 x 4.8 cm
Técnica de Impresión: Serigrafía
Colores: Blanco y 5 Colores

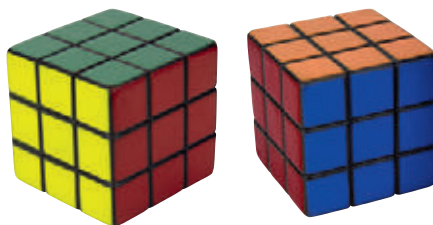
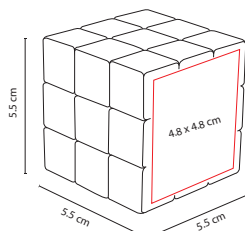

5 Caras de color y una cara blanca para impresión.



■ SOC 930

ANTI-STRESS LIKE

Material: PU
Medida: 9.5 x 8.3 cm
Área de Impresión: 3 x 3 cm
Técnica de Impresión: Serigrafía
Colores: Azul con Blanco
■ ■ ■ Colores GTM: Azul con Blanco

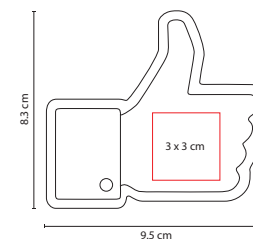



BELLEZA



■ DAM 500

ESPEJO ALINE

Material: Plástico

Medida: 6.3 x 6.3 cm

Área de Impresión: 4.5 x 4.5 cm

Técnica de Impresión: Serigrafía

Colores: A/B/O/P/V

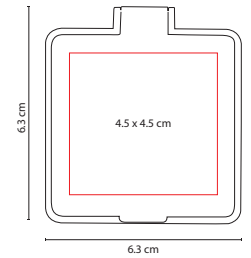



■ DAM 2123

ESPEJO SLASH

Material: Plástico
 Medida: 6.9 x 7.9 cm
 Área de Impresión: 4.5 x 5 cm
 Técnica de Impresión: Serigrafía
 Colores: Translúcido
 Colores GTM: Translúcido

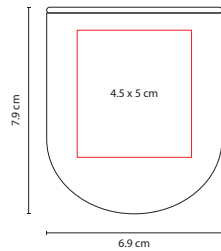

■ DAM 120

ESPEJO LARISA

Material: Plástico
 Medida: 9 x 11.5 cm
 Área de Impresión: 6 x 8.5 cm
 Técnica de Impresión: Serigrafía
 Colores: Negro

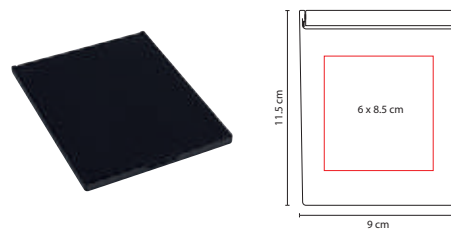

AT

■ DAM 560

ESPEJO FANCY

Material: Plástico
 Medida: 6 cm Diámetro
 Área de Impresión: 5 cm Diámetro
 Técnica de Impresión: Serigrafía
 Colores: AT/BT/GT/PT
 Colores GTM: AT/BT/PT

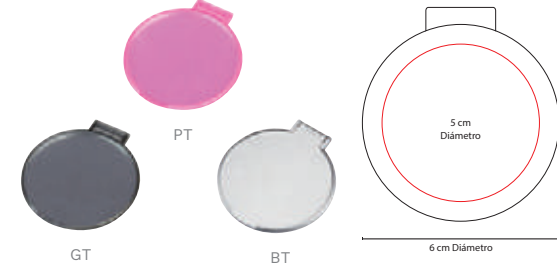

GT

BT





■ DAM 702

ESPEJO CON LUZ AVANTE

Material: Plástico
 Medida: 6.1 x 9 cm
 Área de Impresión: 3.6 x 4.5 cm
 Técnica de Impresión: Serigrafía
 Colores: Blanco
 Colores GTM: Blanco

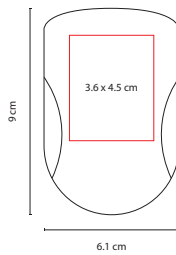

■ DAM 002

ESPEJO BRISEIS

Material: Plástico
 Medida: 8.5 cm Diámetro Espejo / 2 x 10 cm Mango
 Área de Impresión: 1 x 6 cm
 Técnica de Impresión: Serigrafía
 Colores: Plata
 Colores GTM: Plata

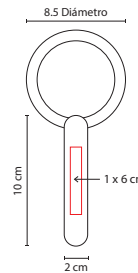

Espejo 1 lado con aumento 2X y 1 lado normal.
 Cuenta con mango para sostener.



■ DAM 014

ESPEJO KEILA

Material: Madera
 Medida: 13 x 23 cm
 Área de Impresión: 9 x 2.5 cm
 Técnica de Impresión: Láser
 Colores: Café

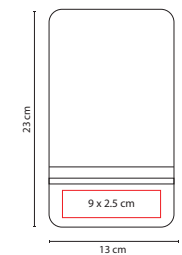

Espejo armable. Incluye 2 piezas.



■ DAM 804

ESPEJO DOLLY

Material: Plástico
 Medida: 7 x 7 cm
 Área de Impresión: 5.5 x 5.5 cm
 Técnica de Impresión: Serigrafía
 Colores: Blanco
 Colores GTM: Blanco



Incluye peine.

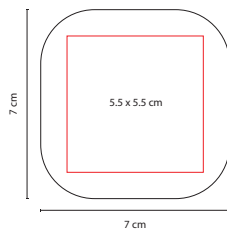

■ DAM 018

CEPILLO ZIVA

Material: Plástico
 Medida: 7.5 x 15 cm
 Área de Impresión: 3 x 4 cm
 Técnica de Impresión: Serigrafía
 Colores: Blanco con Negro



Cepillo anti-frizz, masajeador. Incluye espejo.

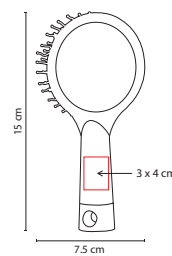

■ DAM 017

CEPILLO BIELLA

Material: Plástico
 Medida: 6 x 15 cm
 Área de Impresión: 2 x 6 cm
 Técnica de Impresión: Serigrafía
 Colores: Blanco con Negro



Cepillo anti-frizz, masajeador.

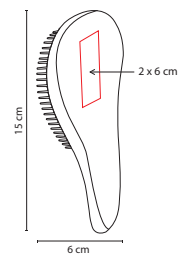



■ DAM 022

COSTURERO ZAMBIA

Material: Plástico
 Medida: 5.3 x 8.8 cm
 Área de Impresión: 3 x 5 cm
 Técnica de Impresión: Serigrafía
 Colores: Blanco



Tapa deslizable. Incluye tijeras, botones, ensartador de aguja, alfiler, hilo, agujas y seguro.



■ U 1071

COSTURERO CON ESPEJO BELLAMY

Material: Plástico
 Medida: 11.5 x 6.3 cm
 Área de Impresión: 9 x 4 cm
 Técnica de Impresión: Serigrafía
 Colores: Blanco

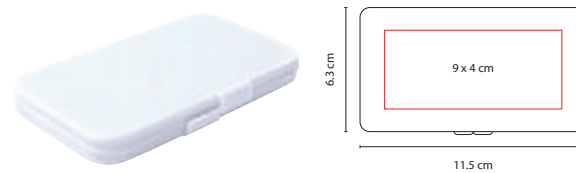

Incluye 9 accesorios.



■ DAM 810

COSTURERO OVALADO AURA

Material: Plástico
 Medida: 7.7 x 5.4 cm
 Área de Impresión: 4.5 x 3.5 cm
 Técnica de Impresión: Serigrafía
 Colores: Blanco Frosty
 Colores GTM: Blanco Frosty

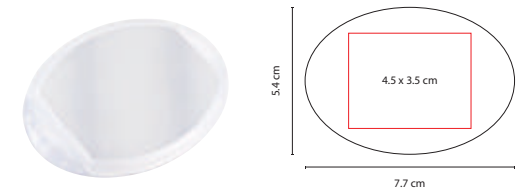

Incluye 4 accesorios.



V

■ DAM 435

SET DE MANICURE **FUNKY**

Material: Plástico
 Medida: 10 x 5.3 cm
 Área de Impresión: 8 x 4 cm
 Técnica de Impresión: Serigrafía
 Colores: A/B/R/V/Y
 ■ ■ Colores GTM: A/B/V

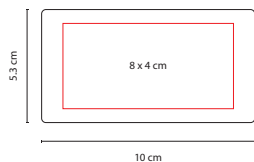

A



R



B



Y

Incluye 4 accesorios.



P

■ DAM 025

SET MANICURE **KYMA**

Material: Plástico
 Medida: 4 x 8.3 cm
 Área de Impresión: 2.5 x 4 cm
 Técnica de Impresión: Serigrafía
 Colores: N/P
 ■ ■ Colores GTM: Negro

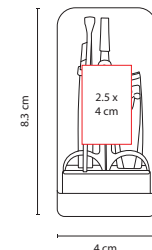

N



Incluye 4 accesorios.





P

■ DAM 004

SET DE MANICURE **GENOVA**

Material: Curpiel
 Medida: 11 x 6.5 cm
 Área de Impresión: 7 x 4 cm
 Técnica de Impresión: Serigrafía
 Colores: G/N/P
 Colores GTM: N/P

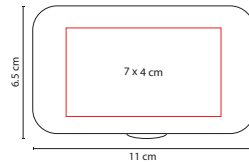

Incluye 4 accesorios.



■ DAM 773

SET DE MANICURE Y BROCHAS **YOUNG**

Material: Curpiel
 Medida: 13.2 x 8 cm
 Área de Impresión: 10 x 6 cm
 Técnica de Impresión: Láser / Serigrafía
 Colores: Negro
 Colores GTM: Negro

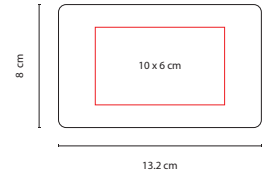

Incluye 10 accesorios (5 brochas, 5 accesorios para manicure y un espejo).



■ DAM 540

SET DE BROCHAS **GLAMOUR**

Material: Plástico
 Medida: 5.1 x 12.1 cm
 Área de Impresión: 3.4 x 3 cm
 Técnica de Impresión: Serigrafía /
 Tampografía
 Colores: Plata

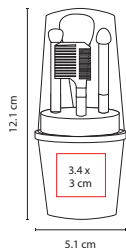

Incluye 5 accesorios.



■ DAM 013

SET DE BROCHAS **KIYA**

Material: Curpiel
 Medida: 7.5 x 12 cm
 Área de Impresión: 4 x 4 cm
 Técnica de Impresión: Serigrafía
 Colores: Negro

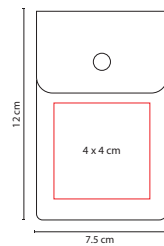

Incluye 4 accesorios.



■ DAM 006

SET DE BROCHAS **ANNIA**

Material: Curpiel
 Medida: 8.4 x 16 cm
 Área de Impresión: 5 x 5 cm
 Técnica de Impresión: Serigrafía
 Colores: Negro

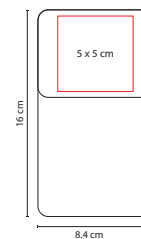

Incluye 5 accesorios y espejo.





■ DAM 570

SET DE BROCHAS **CRYSTAL FACE**

Material: Plástico
 Medida: 3.2 x 10.6 cm
 Área de Impresión: 2.2 x 5.8 cm
 Técnica de Impresión: Serigrafía
 Colores: Transparente
 Colores GTM: Transparente

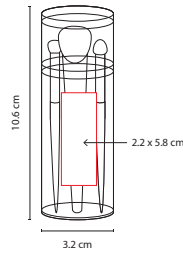

Incluye 5 accesorios.



■ DAM 530

SET BROCHAS Y ESPEJO **DONNA**

Material: Plástico
 Medida: 8.2 x 5.3 cm
 Área de Impresión: 6.5 x 4 cm
 Técnica de Impresión: Serigrafía
 Colores: Transparente
 Colores GTM: Transparente

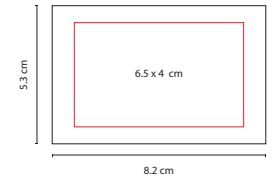

Incluye 5 accesorios y espejo.



P

■ DAM 009

COSMETIQUERA LORELEI

Material: Yute

Medida: 25 x 16 cm

Área de Impresión: 13 x 4 cm

Técnica de Impresión: Serigrafía

Colores: A/N/P/R

■ ■ Colores GTM: A/P/R

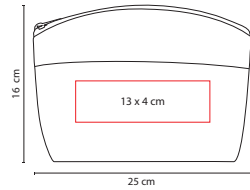

R

■ DAM 010

COSMETIQUERA KIARA

Material: Poliéster

Medida: 28 x 14.5 x 7.5 cm

Área de Impresión: 18 x 6.5 cm

Técnica de Impresión: Bordado

Colores: A/N/R

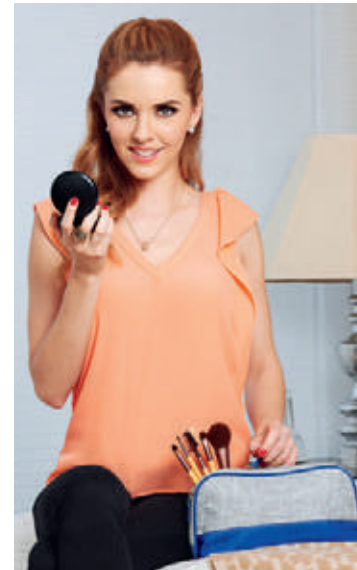
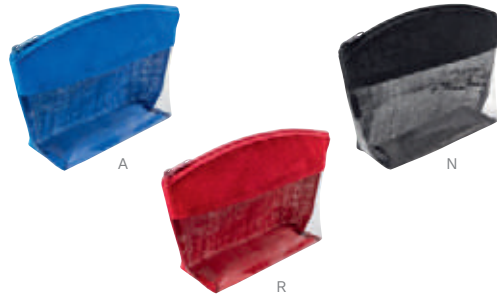
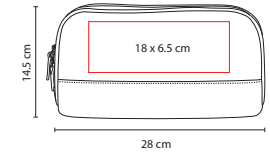

A



N





A

■ DAM 007

COSMETIQUERA **BRIANA**

Material: Poliéster
 Medida: 20 x 14 x 3 cm
 Área de Impresión: 12 x 6 cm
 Técnica de Impresión: Serigrafía
 Colores: A/N/P

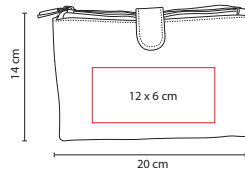

N

P



2 Compartimentos internos.



P

■ SIN 128

COSMETIQUERA **SELLA**

Material: PVC
 Medida: 20.5 x 7.5 x 5.5 cm
 Área de Impresión: 16 x 5 cm
 Técnica de Impresión: Serigrafía
 Colores: A/B/P
 Colores GTM: A/B/P

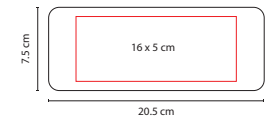

A

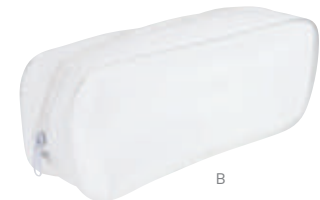

B



C

■ DAM 003

COSMETIQUERA LOIRA

Material: Poliéster / Curpiel
 Medida: 21 x 12 x 5 cm
 Área de Impresión: 14 x 6 cm
 Técnica de Impresión: Serigrafía
 Colores: A/C/N
 Colores GTM: A/C/N

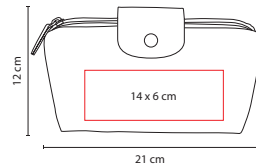

A



N



N

■ DAM 030

COSMETIQUERA LEXY

Material: Algodón
 Medida: 25 x 16.5 cm
 Área de Impresión: 16 x 6 cm
 Técnica de Impresión: Serigrafía
 Colores: N/P

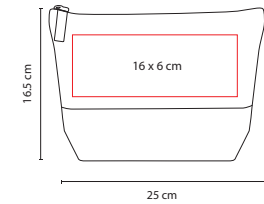

P





G

■ DAM 501

COSMETIQUERA **PLATINUM**

Material: Microfibra
 Medida: 25.5 x 20 x 15.5 cm
 Área de Impresión: 21 x 10 cm
 Técnica de Impresión: Bordado / Serigrafía
 Colores: G/N/P



P

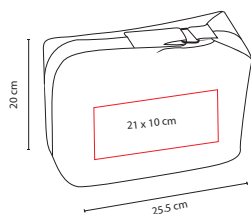

N

3 Compartimentos internos.



N

■ DAM 502

COSMETIQUERA **VICTORIAS**

Material: Microfibra
 Medida: 19.5 x 16.5 x 4.5 cm
 Área de Impresión: 5 x 3 cm
 Técnica de Impresión: Bordado / Serigrafía
 Colores: G/N/P

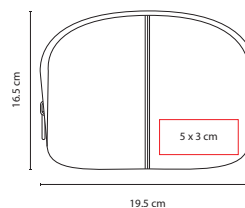

G



P



P

■ DAM 008

COSMETIQUERA **ELBE**

Material: Curpiel / PVC
 Medida: 21 x 15 x 7 cm
 Área de Impresión: 14 x 6 cm
 Técnica de Impresión: Serigrafía
 Colores: G/P

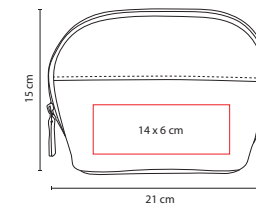

G

Incluye 2 compartimentos y espejo.



P

■ SIN 520

COSMETIQUERA CHIC

Material: PVC
 Medida: 27 x 16.5 x 9 cm
 Área de Impresión: 16 x 11 cm
 Técnica de Impresión: Serigrafía
 Colores: N/P

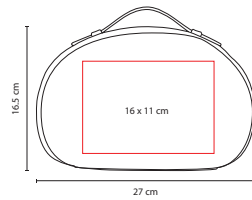

N



P

to^{ss}sh®

■ DAM 005

COSMETIQUERA STELLA

Material: Poliéster
 Medida: 25 x 17 x 5 cm
 Área de Impresión: 15 x 5 cm
 Técnica de Impresión: Serigrafía
 Colores: G/P

■ Colores GTM: Rosa

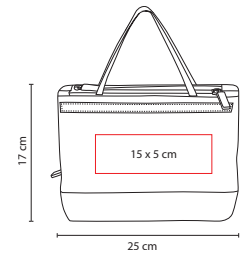

G

3 Compartimentos internos con cierre.





■ DAM 019

KIT DE BAÑO **ALTHEA**

Material: Plástico / Poliéster
 Medida: 18 x 14.5 cm
 Área de Impresión: 8 x 6 cm
 Técnica de Impresión: Serigrafía
 Colores: Blanco

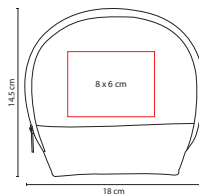

Incluye 4 accesorios de baño: 2 esponjas, cepillo y guante.



■ DAM 015

ALHAJERO **ALHAMA**

Material: Plástico
 Medida: 13 x 10 cm
 Área de Impresión: 7 x 7 cm
 Técnica de Impresión: Serigrafía /
 Tampografía
 Colores: Blanco con Gris

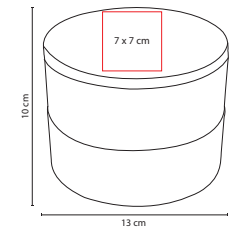



HERRAMIENTAS



NAVAJAS



ST 020

NAVAJA IVER

Material: Metal

Medida: 3 x 9 cm

Área de Impresión: 1 x 3 cm

Técnica de Impresión: Pantógrafo / Serigrafía

Colores: A/N/R/S

Colores GTM: A/N/R/S

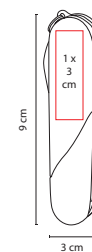

S



A



N



R



6 Funciones. Incluye funda.



XO-TOOL® ■ ST 081

NAVAJA COLVILLE

Material: Metal
Medida: 2.5 x 8.8 cm

Área de Impresión: 1 x 4 cm

Técnica de Impresión: Pantógrafo / Serigrafía

Colores: Plata

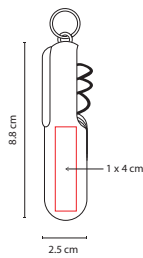

1 LED y 11 funciones. Incluye 3 baterías de botón y funda.



XO-TOOL® ■ ST 035

NAVAJA EMORY

Material: Metal
Medida: 2.6 x 9.5 cm

Área de Impresión: 0.8 x 3 cm

Técnica de Impresión: Pantógrafo / Serigrafía

Colores: Gris Oxford Metalizado

■ ■ Colores GTM: Gris Oxford Metalizado

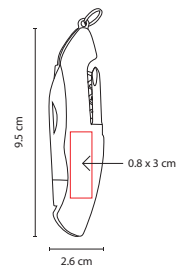

6 Funciones. Incluye funda.



■ HER 06

MINI NAVAJA BULLET

Material: Metal
Medida: 1.9 x 6 cm

Área de Impresión: 1 x 2.5 cm

Técnica de Impresión: Láser / Pantógrafo / Serigrafía

Colores: Plata

■ ■ Colores GTM: Plata

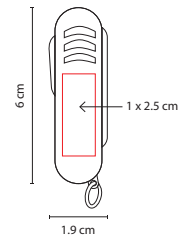

Contiene navaja, tijeras y destapador con punta de desarmador plano.





LÁMPARAS



■ LAM 600

LÁMPARA CON NAVAJA **PATHFINDER**

Material: Metal / Plástico

Medida: 4.5 x 14 cm

Área de Impresión: 1.7 x 4 cm

Técnica de Impresión: Pantógrafo / Serigrafía

Colores: Plata con Negro

Colores GTM: Plata con Negro

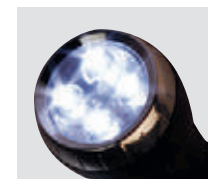
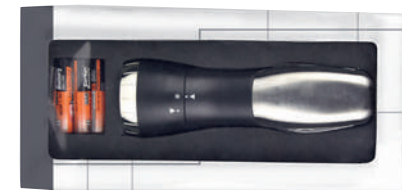
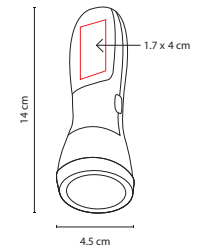

4 LEDs con flash y navaja de 8 funciones. Incluye baterías (3 pilas AAA) y estuche.



R

■ LAM 1100

LÁMPARA ATRON

Material: Aluminio/ Plástico

Medida: 2.3 x 9 cm

Área de Impresión: 1 x 4 cm

Técnica de Impresión: Tampografía / Láser

Colores: A/R

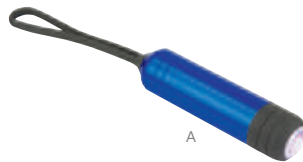
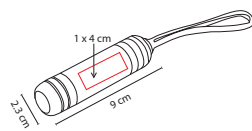

A



1 LED con 2 puntas planas y 2 puntas de cruz.



A

■ LAM 750

LÁMPARA SKEN

Material: Plástico

Medida: 3.8 x 12.3 cm

Área de Impresión: 1.5 x 4.5 cm

Técnica de Impresión: Serigrafía

Colores: A/G/R

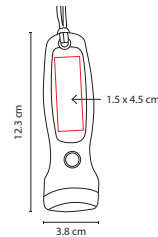

R



G

2 LEDs. Incluye imán, cordón y 2 baterías de botón.



N

■ LAM 100

LÁMPARA KOBOK

Material: Metal / Plástico

Medida: 1.5 x 6.2 cm

Área de Impresión: 1.1 x 2.3 cm

Técnica de Impresión: Serigrafía

Colores: A/N/R/S

Colores GTM: A/N/R/S

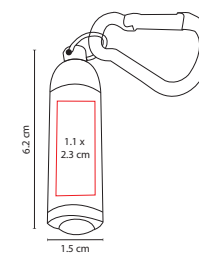

S



R



A

1 LED. Incluye gancho y 3 baterías de botón.





XO-TOOL ■ **LAM 800**

LÁMPARA OBELIX

Material: Metal
 Medida: 3 x 9.7 cm
 Área de Impresión: 2 x 7 cm
 Técnica de Impresión: Pantógrafo / Serigrafía
 Colores: Gris Metalizado



9 LEDs. En forma triangular, incluye correa y baterías (3 pilas AAA).



A

■ **LAM 1010**

LÁMPARA VANADIS

Material: Aluminio / Plástico
 Medida: 4.5 x 11.2 cm
 Área de Impresión: 1.5 x 4 cm
 Técnica de Impresión: Tampografía / Láser
 Colores: A/R

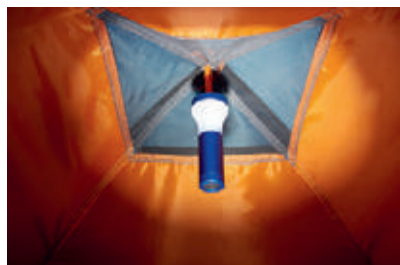

5 LEDs con 3 funciones: linterna, lámpara y luz intermitente. Cuenta con asa para colgar. 3 Baterías AAA no incluidas.



■ **LAM 1450**

LÁMPARA FRICTION LIGHT

Material: Plástico
 Medida: 5.1 x 10.5 cm
 Área de Impresión: 2.7 x 5 cm
 Técnica de Impresión: Serigrafía / Goteado en Resina
 Colores: Humo

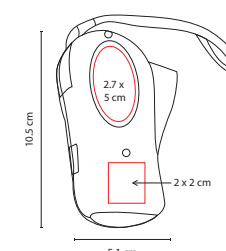

3 LEDs. No necesita baterías, se recarga por fricción. Incluye cordón.



A

XO-TOOL® ■ LAM 700

LÁMPARA RUSH

Material: Metal
 Medida: 3.2 x 4.5 cm
 Área de Impresión: 2.2 x 1.1 cm
 Técnica de Impresión: Pantógrafo / Serigrafía
 Colores: A/N/R
 Colores GTM: A/N/R

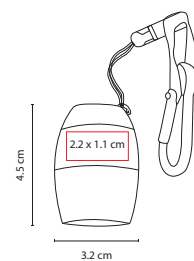

6 LEDs. Incluye correa con gancho y 2 baterías de botón.



R

XO-TOOL® ■ LAM 550

LÁMPARA ANGUS

Material: Aluminio
 Medida: 2.8 x 9.1 cm
 Área de Impresión: 2.2 x 3.8 cm
 Técnica de Impresión: Pantógrafo / Serigrafía
 Colores: A/R/S Metalizados

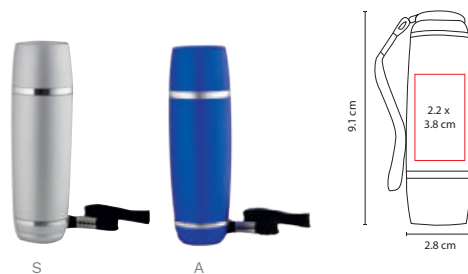

9 LEDs. Incluye cordón y baterías (3 pilas AAA).



IMÁN

XO-TOOL® ■ LAM 1000

LÁMPARA MOSELA

Material: Plástico
 Medida: 4 x 10.5 x 3 cm
 Área de Impresión: 3 x 5.5 cm
 Técnica de Impresión: Serigrafía
 Colores: Blanco
 Colores GTM: Blanco

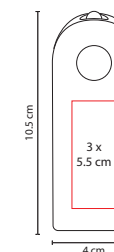

16 LEDs con cubierta giratoria y correa de mano.
 Imán en la parte posterior. No incluye baterías (3 pilas AAA).





■ LAM 1070

LÁMPARA DE ESCRITORIO SWAN

Material: Plástico
 Medida: 10.3 x 34 cm
 Área de Impresión: 4 x 2 cm
 Técnica de Impresión: Serigrafía / Tampografía
 Colores: Blanco

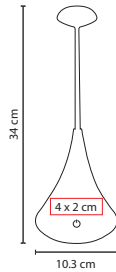

12 LEDs. Cuello flexible y ajustable. Funciona con baterías y con cable USB.
 Intensidad de luz ajustable. No incluye baterías (3 pilas AA).



P

■ LAM 300

LÁMPARA RIDER

Material: Plástico
 Medida: 1.4 x 12.7 cm
 Área de Impresión: 1 x 2.7 cm
 Técnica de Impresión: Serigrafía
 Colores: B/P
 Colores GTM: Plata

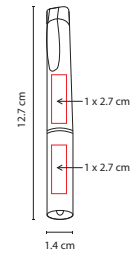

B

1 LED, luz blanca. Incluye 3 baterías de botón.



■ LAM 1090

LÁMPARA DE ESCRITORIO **TAUBER**

Material: Plástico / Metal
Medida: 8 x 22 cm

Área de Impresión: 5 x 2 cm

Técnica de Impresión: Serigrafía / Tampografía

Colores: Blanco

☑ Colores GTM: Blanco

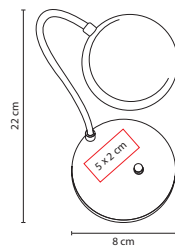

5 LEDs con cuello flexible y ajustable. Baterías no incluidas (3 pilas AA).



■ LAM 650

LÁMPARA **ALBANY**

Material: Plástico

Medida: 8.5 x 23.5 cm

Área de Impresión: 3 x 5 cm

Técnica de Impresión: Serigrafía / Tampografía

Colores: Blanco

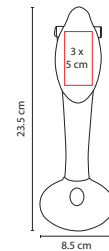

1 LED, luz blanca. Incluye baterías (3 pilas AA).





DESARMADORES Y FLEXÓMETROS



B



R



A

HER 043

DESARMADOR-DESTAPADOR KIOWA

Material: Plástico
 Medida: 3.7 x 8 cm
 Área de Impresión: 2 x 2 cm
 Técnica de Impresión: Serigrafía
 Colores: A/B/R

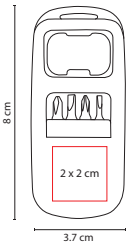

Incluye 4 puntas de desarmador y destapador.



N

HER 031

DESARMADOR AZUER

Material: Plástico / Metal
Medida: 2 x 9 cm
Área de Impresión: 1.5 x 4 cm
Técnica de Impresión: Serigrafía
Colores: A/N/O/R/V

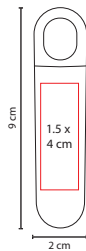

V



O



R



A

Contiene 2 puntas de cruz y 2 puntas planas de diferentes tamaños.



RT

HER 02

DESARMADOR HIGHLANDER

Material: Plástico
Medida: 3 x 10.8 cm
Área de Impresión: 1.5 x 5 cm
Técnica de Impresión: Serigrafía
Colores: AT/NT/RT
Colores GTM: AT/NT/RT

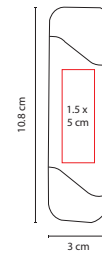

AT



NT

Contiene 6 diferentes puntas de desarmador (3 puntas de cruz y 3 puntas planas).





AT

HER 07

DESARMADOR FALCOR

Material: Plástico / Metal
 Medida: 3.2 x 9.8 cm
 Área de Impresión: 2 x 6 cm
 Técnica de Impresión: Serigrafía
 Colores: AT/NT/RT

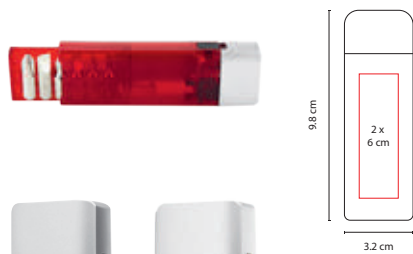

NT

RT

Contiene 6 diferentes puntas de desarmador, lámpara y clip.
 Incluye 4 baterías de botón.



HER 045

DESARMADOR MÚLTIPLE VINDEL

Material: Plástico
 Medida: 4 x 9.8 cm
 Área de Impresión: 0.7 x 4 cm
 Técnica de Impresión: Serigrafía
 Colores: Amarillo con Negro

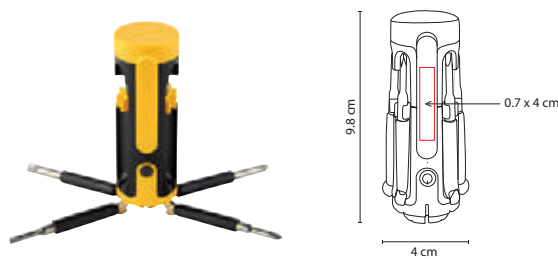

4 LEDS con 6 puntas de desarmador y clip.
 Baterías (2 Pilas AAA) no incluidas.



Xo-TOOL® HER 016

DESARMADOR AZADY

Material: Metal
 Medida: 1.4 x 11.1 cm
 Área de Impresión: 0.8 x 1.8 cm
 Técnica de Impresión: Láser / Pantógrafo / Serigrafía
 Colores: Gris Oxford Metalizado
 Colores GTM: Gris Oxford Metalizado



Contiene 8 diferentes puntas de desarmador
 (4 puntas de cruz y 4 puntas planas). Incluye clip.



A

HER 041

DESARMADOR INSER

Material: Plástico
Medida: 2.2 x 10.2 cm
Área de Impresión: 1 x 4 cm
Técnica de Impresión: Serigrafía
Colores: A/N/R
Colores GTM: A/N/R

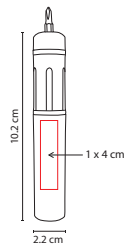

R

N



Desarmador con sistema giratorio. Incluye 6 puntas de desarmador.



HER 050

FLEXÓMETRO SILAY

Material: Acero inoxidable / Plástico
Medida: 7.2 x 6.5 cm
Área de Impresión: 3.5 x 3.5 cm
Técnica de Impresión: Láser / Serigrafía
Colores: Plata

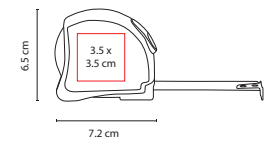

Flexómetro cinta metálica de 3 m. Incluye clip metálico.





■ **HER 049**
FLEXÓMETRO BOUGAINVILLE

Material: Plástico
Medida: 8 x 6.1 cm
Área de Impresión: 3.5 x 3.5 cm
Técnica de Impresión: Serigrafía
Colores: Negro

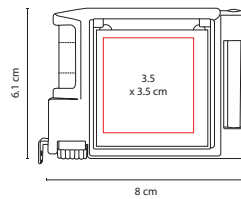

Flexómetro cinta metálica de 2 m.
Incluye notas adhesivas, bolígrafo tinta negra, clip metálico y nivel.



■ **HER 019**
FLEXÓMETRO LUCCA

Material: Plástico / Metal
Medida: 6.5 x 6.5 cm
Área de Impresión: 4.4 cm Diámetro
Técnica de Impresión: Goteado en Resina / Serigrafía
Colores: Blanco
Colores GTM: Blanco

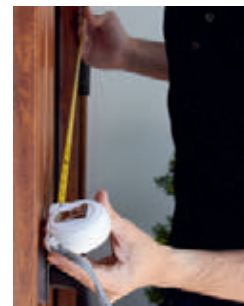
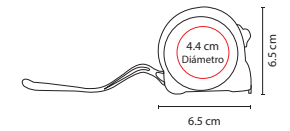

Flexómetro cinta metálica de 5 m. Incluye correa, clip y seguro.

SET DE HERRAMIENTAS Y MULTIFUNCIONALES



HERRAMIENTAS



SET DE HERRAMIENTAS Y MULTIFUNCIONALES



518



HER 018

PINZAS YAVIA

Material: Metal

Medida: 5 x 9.7 cm

Área de Impresión: 1 x 4 cm

Técnica de Impresión: Pantógrafo / Serigrafía

Colores: Gris Oxford Metalizado

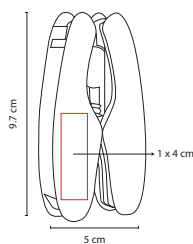

9 Funciones: lima para uñas, navaja, desarmador de cruz, destapador con desarmador plano, pinzas, navaja de hoja curva, desarmador plano, serrucho, navaja dentada. Incluye funda.



XO-TOOL ■ **HER 08**

SET DE HERRAMIENTAS **CONRAD**

Material: Metal / Plástico
 Medida: 11.7 x 10 cm
 Área de Impresión: 10 x 8 cm
 Técnica de Impresión: Serigrafía
 Colores: Plata
 Colores GTM: Plata

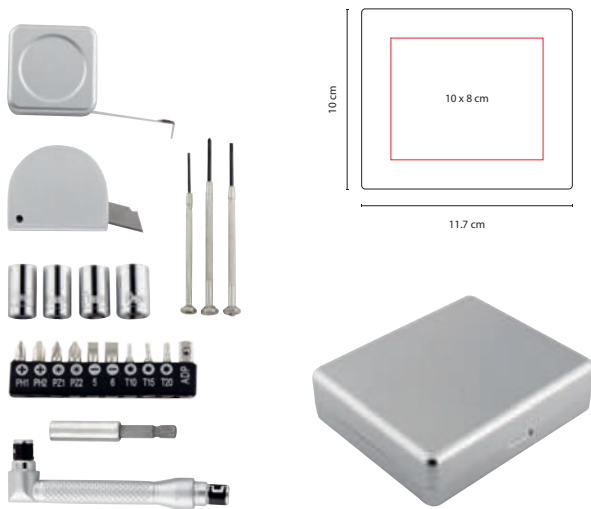

Contiene 3 desarmadores de mano, flexómetro de 1 m, cúter, 10 puntas de desarmadores diferentes, dados y extensión. Incluye estuche.



XO-TOOL ■ **HER 015**

MINI PINZAS **QUARK**

Material: Metal
 Medida: 3 x 6.8 cm
 Área de Impresión: 0.5 x 1.5 cm
 Técnica de Impresión: Láser / Pantógrafo
 Colores: Plata
 Colores GTM: Plata

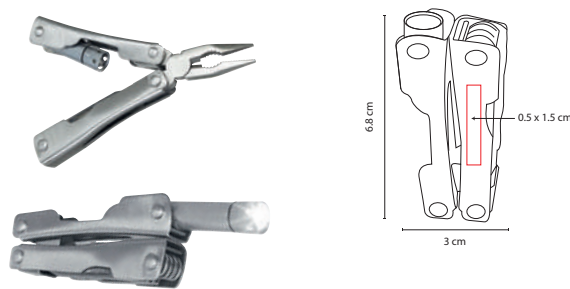

Mini pinzas de 7 funciones, cuenta con lámpara de 1 LED, navaja, desarmador de cruz, serrucho, destapador con punta de desarmador plano. Incluye funda y 3 baterías de botón.



XO-TOOL ■ **HER 05**

MARTILLO **THOR** MULTIUSOS

Material: Metal
 Medida: 7.5 x 13.5 cm
 Área de Impresión: 1 x 5 cm
 Técnica de Impresión: Pantógrafo / Serigrafía
 Colores: Plata



Contiene martillo, pinzas, navaja, tijeras, desarmador, sierra y lima. Incluye estuche.



HER 010

SET DE HERRAMIENTAS **INDUSTRY**

Material: Metal / Plástico / Poliéster
 Medida: 17 x 9 cm
 Área de Impresión: 13 x 6 cm
 Técnica de Impresión: Serigrafía
 Colores: Negro

Colores GTM: Negro

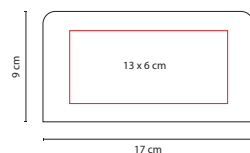

Contiene desarmador, 10 puntas de desarmador, llaves hexagonales, dado extensión y 4 dados.
 Incluye estuche de tela.



HER 033

SET DE HERRAMIENTAS **VALGUS**

Material: Metal / Plástico
 Medida: 20 x 14,4 cm
 Área de Impresión: 6,5 x 2 cm
 Técnica de Impresión: Tampografía
 Colores: Negro

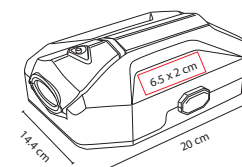

Contiene pinzas de punta, lámpara desmontable de 13 LEDs (3 pilas AAA no incluidas), flexómetro 1 m, correa ajustable con adaptador para lámpara, 2 desarmadores relojero, dado extensión, desarmador, 10 puntas para desarmador, 3 llaves hexagonales y cúter.





HER 03

SET DE HERRAMIENTAS ROADMASTER

Material: Metal / Plástico
 Medida: 25 x 24 cm
 Área de Impresión: 14 x 11 cm
 Técnica de Impresión: Serigrafía

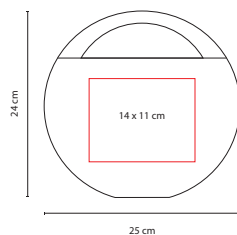

Contiene 2 pinzas (de punta y electricista), flexómetro de 1 m, 4 desarmadores de mano, 1 desarmador con 20 puntas diferentes. Incluye estuche.



HER 014

SET DE HERRAMIENTAS HANCK

Material: Metal / Plástico
 Medida: 25.5 x 19.7 cm
 Área de Impresión: 18 x 10 cm
 Técnica de Impresión: Serigrafía
 Colores: Blanco con Negro

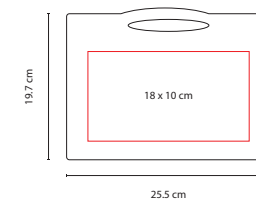

Colores GTM: Blanco con Negro



Contiene flexómetro de 2 m, desarmador plano y de cruz, martillo, verificador de corriente y pinzas. Incluye estuche.



HER 023

SET DE HERRAMIENTAS AUTHIE

Material: Metal / Plástico
Medida: 16.5 x 9 cm

Área de Impresión: 12 x 6 cm
Técnica de Impresión: Serigrafía

Colores: Negro

Colores GTM: Negro

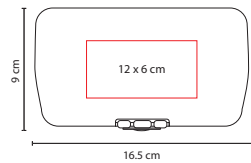

Contiene pinzas de punta, 5 llaves hexagonales, 10 puntas de desarmador, desarmador, dado extensión y 4 dados. Incluye estuche.



HER 042

SET DE HERRAMIENTAS LAMPAG

Material: Metal / Plástico
Medida: 21.5 x 7 cm

Área de Impresión: 14 x 4 cm
Técnica de Impresión: Serigrafía

Colores: Plata

Colores GTM: Plata

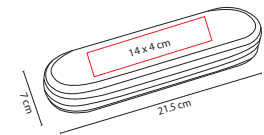

Contiene desarmador, 4 dados, 10 puntas para desarmador, cutter y 5 llaves hexagonales. Incluye estuche.





HER 048

SET DE HERRAMIENTAS PITCAIRN

Material: Plástico / Acero
 Medida: 13.5 x 8 cm
 Área de Impresión: 10 x 3 cm
 Técnica de Impresión: Serigrafía
 Colores: Negro

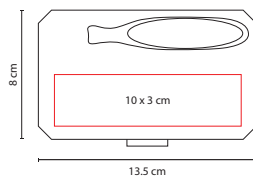

Contiene desarmador, 8 dados y 16 puntas para desarmador. Incluye estuche.



HER 024

SET DE HERRAMIENTAS APOLO

Material: Metal / Plástico
 Medida: 20 x 14 cm
 Área de Impresión: 7.4 x 3.9 cm
 Técnica de Impresión: Serigrafía /
 Goteado en Resina
 Colores: Hueso con Gris

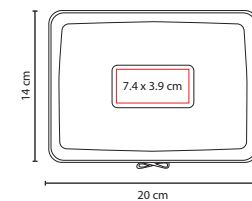

Contiene pinzas de punta, 5 llaves hexagonales, 10 puntas de desarmador, desarmador, dado extensión y 4 dados. Incluye estuche.



HER 032

SET DE HERRAMIENTAS WALNEY

Material: Metal / Plástico

Medida: 24.7 x 16.3 cm

Área de Impresión: 7.9 x 3.9 cm

Técnica de Impresión: Tampografía / Goteado en Resina

Colores: Gris

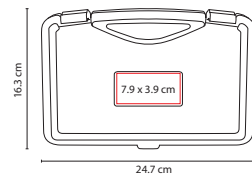

Contiene pinzas de electricista, flexómetro 3m (con área de 3.5 cm para goteado en resina), lámpara 9 leds (3 pilas AAA, no incluidas), 5 llaves hexagonales, desarmador de cruz, desarmador plano, cúter, cinta aislante y detector de voltaje.



HER 040

SET DE HERRAMIENTAS BALTIMORE

Material: Plástico / Metal

Medida: 24 x 35 cm

Área de Impresión: 14 x 15 cm

Técnica de Impresión: Tampografía/ Serigrafía

Colores: Negro

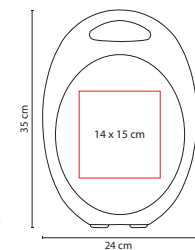

Contiene 2 desarmadores planos, 2 desarmadores cruz, 8 llaves hexagonales (1.5-6 mm), matraca con adaptador y 8 dados (6-13 mm), martillo, cúter, 1 pinzas de punta/corte, flexómetro 3.5 m, desarmador con adaptador para puntas, 2 juegos de puntas (cruz, plano, torx, cuadrado). Incluye estuche.





AUTOMÓVIL



HER 047

SET DE EMERGENCIA HUESCA

Material: Tela / Plástico / Metal

Medida: 26.5 x 14

Área de Impresión: 20 x 5 cm

Técnica de Impresión: Serigrafía

Colores: Negro

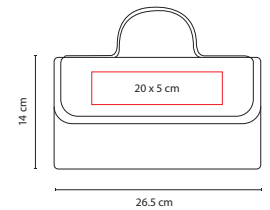

Contiene cables pasa corriente, 9 dados, medidor de presión de aire, desarmador punta de cruz, desarmador punta plana, desarmador para dados. Incluye estuche de tela.



HER 020

SET DE EMERGENCIAS ANKER

Material: Plástico / Poliéster / Metal

Medida: 25 x 15 cm Estuche

Área de Impresión: 11 x 10 cm Estuche / 3 x 1.5 cm Placa

Técnica de Impresión: Láser en Placa Metálica / Serigrafía

Colores: Negro

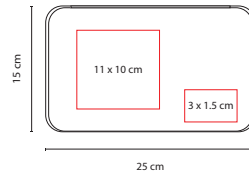

Contiene cables para pasar corriente (100 amp), medidor de presión de aire (50 psi), guantes, lámpara con 7 LEDs, impermeable, curitas, pinza y estuche. Baterías (3 pilas AAA) no incluidas.



HER 012

SET DE HERRAMIENTAS EMERGENCY

Material: Estuche de Loneta / Metal / Plástico

Medida: 20.5 x 28.8 cm

Área de Impresión: 16 x 24 cm

Técnica de Impresión: Bordado / Serigrafía

Colores: Negro

Colores GTM: Negro

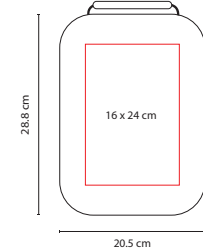

Contiene cables para pasar corriente (300 amp), lámpara de 16 cm, pinzas, desarmador y puntas para desarmador. Baterías (4 pilas AA) no incluidas.





■ HER 046

CONTENEDOR MULTIUSOS **BANJUL**

Material: Plástico
 Medida: 20 x 9.6 cm
 Área de Impresión: 5 cm Diámetro
 Técnica de Impresión: Tampografía
 Colores: Negro

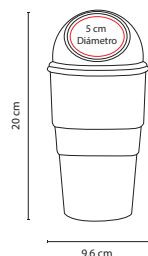

Contenedor multiusos para AUTOMÓVILmóvil.



A

■ SIN 078

BOLSA **MARIEL**

Material: Non Woven
 Medida: 18 x 28 cm
 Área de Impresión: 12 x 16 cm
 Técnica de Impresión: Serigrafía
 Colores: A/N/R/V
 Colores GTM: Negro

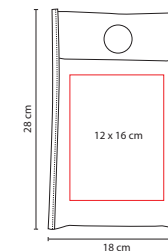

R



V



N

Bolsa para basura portátil.

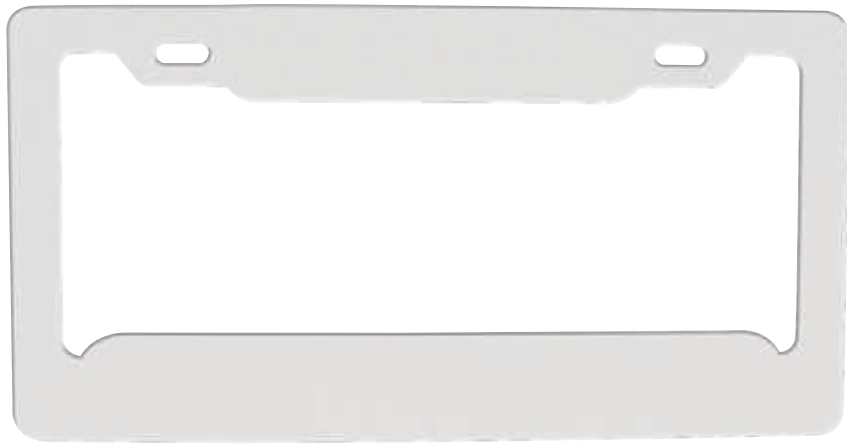

B

■ PRO 024

PORTA PLACA

Material: Plástico
Medida: 31 x 16 cm
Área de Impresión: 23 x 2 cm
Técnica de Impresión: Serigrafía
Colores: B/N

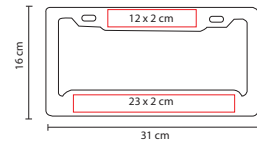

N

Porta placa de plástico para AUTOMÓVILmóvil.



■ SLD 031

TOALLAS FINKE

Material: Plástico
Medida: 7.5 x 12.7 cm
Área de Impresión: 4 x 3 cm
Técnica de Impresión: Tampografía
Colores: Gris

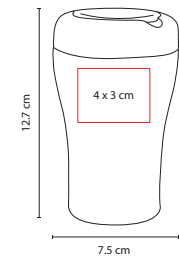

Contiene 25 toallitas húmedas.





■ HER 027

COMPRESOR DE AIRE **ORIO**L

Material: Plástico
 Medida: 19 x 19 cm
 Área de Impresión: 10 x 5 cm
 Técnica de Impresión: Serigrafía
 Colores: Plata
 Colores GTM: Plata

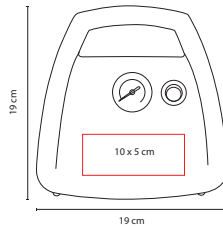

Compresor de aire para AUTOMÓVILmóvil, 150 psi. Incluye desarmador con 10 diferentes puntas, 1 válvula y 2 boquillas. Para su funcionamiento es necesario conectar al encendedor del AUTOMÓVILmóvil.



■ HER 01

MEDIDOR DE PRESIÓN DE AIRE PARA **LLANTAS**

Material: Plástico
 Medida: 1 x 8.2 cm
 Área de Impresión: 0.7 x 4 cm
 Técnica de Impresión: Serigrafía
 Colores: Plata
 Colores GTM: Plata

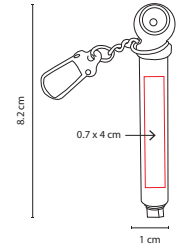

Máxima medición 50 libras.

NIÑOS



ESCOLARES



■ DPO 026

LÁPIZ DE PLÁSTICO

Material: Plástico
 Medida: 0.7 x 19 cm
 Área de Impresión: 0.6 x 10 cm
 Técnica de Impresión: Serigrafía
 Colores: A/AM/B/N/R/V/Y

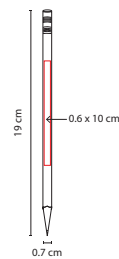

V AM Y B A R N

Lápiz punta 2B, No. 2.

■ DPO 008

LÁPIZ DE MADERA

Material: Madera
 Medida: 0.7 x 19 cm
 Área de Impresión: 0.6 x 10 cm
 Técnica de Impresión: Serigrafía
 Colores: A/AM/B/N/R/V/Y
 Colores GTM: A/AM/B/N/R/V/Y

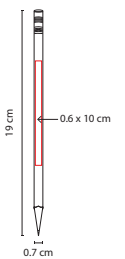

A AM Y B V R N

Lápiz punta 2B, No. 2.



■ DPO 011-1

COLORES CORTOS

Material: Madera / Caja de Cartón

Medida: 4.6 x 8.8 cm

Área de Impresión: 3 x 4 cm

Técnica de Impresión: Serigrafía

Colores: Blanco

■ ■ Colores GTM: Blanco

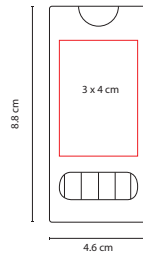

Caja de cartón con 6 colores cortos.



■ DPO 014

CAJA DE CRAYONES

Material: Cera / Caja de Cartón

Medida: 4.3 x 9.2 cm

Área de Impresión: 3 x 4.5 cm

Técnica de Impresión: Serigrafía

Colores: Blanco

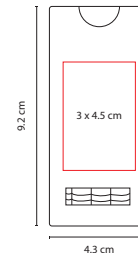

Caja de cartón con 5 crayones de varios colores.



■ INF 014

CRAYONES CANAIMA

Material: Cartón

Medida: 3.5 x 10.3 cm

Área de Impresión: 1.5 x 4 cm

Técnica de Impresión: Serigrafía

Colores: Beige

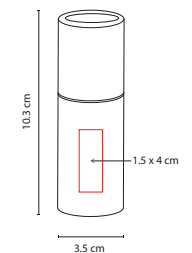

Estuche de cartón con 8 crayones de varios colores.



■ KIT INF 100

KIT ESCOLAR **DRAWING**

Material: Plástico
 Medida: 20 x 14.3 cm
 Área de Impresión: 11 x 7 cm
 Técnica de Impresión: Serigrafía
 Colores: Translúcido

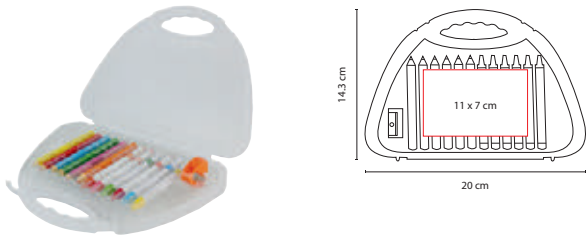

Incluye sacapuntas, 6 crayones y 6 colores.



■ DPO 025

CRAYÓN **KANDI**

Material: Plástico
 Medida: 5.5 x 6 cm
 Área de Impresión: 1.6 cm Diámetro
 Técnica de Impresión: Goteado en Resina
 Colores: Blanco

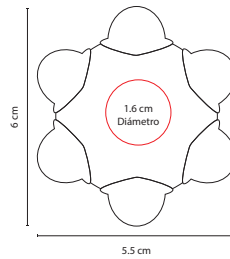

Incluye 6 crayones de varios colores.



■ INF 141

ESTUCHE DE ACUARELAS **ARTWORK**

Material: Plástico
 Medida: 21 x 9.5 cm
 Área de Impresión: 14 x 6 cm
 Técnica de Impresión: Serigrafía
 Colores: Blanco

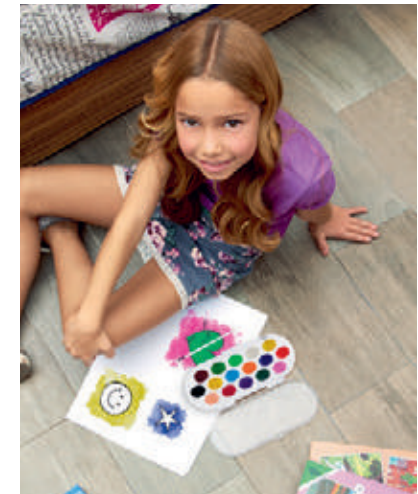
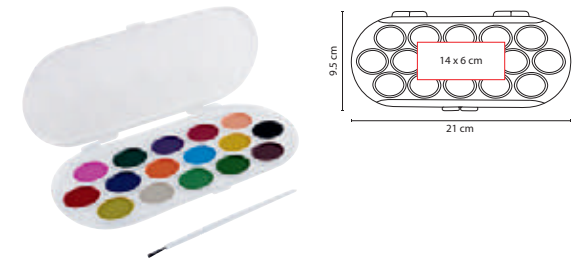

Estuche con 16 acuarelas y pincel.

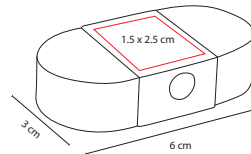

■ DPO 019

BORRADOR SACAPUNTAS SKET

Material: Plástico / Goma
 Medida: 6 x 3 cm
 Área de Impresión: 1.5 x 2.5 cm
 Técnica de Impresión: Serigrafía
 Colores: Blanco
 Colores GTM: Blanco

Incluye borrador, sacapuntas y compartimento para guardar residuos de lápiz.

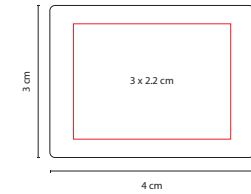

■ DPO 010-1

BORRADOR

Material: Goma
 Medida: 4 x 3 cm
 Área de Impresión: 3 x 2.2 cm
 Técnica de Impresión: Serigrafía
 Colores: Blanco
 Colores GTM: Blanco

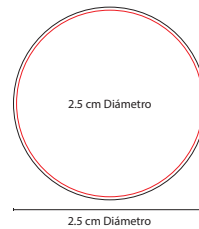

■ SOC 050

BORRADOR BALÓN

Material: Goma
 Medida: 2.5 Diámetro
 Área de Impresión: 2.5 cm Diámetro
 Técnica de Impresión: Serigrafía
 Colores: Blanco con Negro

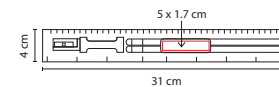

■ PRE 003

SET DE REGLA CON ACCESORIOS

Material: Plástico
 Medida: 31 x 4 cm
 Área de Impresión: 5 x 1.7 cm
 Técnica de Impresión: Serigrafía
 Colores: Blanco
 Colores GTM: Blanco



Incluye 2 lápices, 1 borrador, 1 sacapuntas y regla de 30 cm.



R

■ DPO 007

REGLA TRANSLÚCIDA

Material: Plástico
 Medida: 31.5 x 4 cm
 Área de Impresión: 28 x 2 cm
 Técnica de Impresión: Serigrafía
 Colores: A/R/V/W/Y

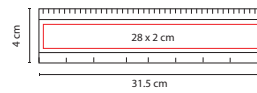

Regla de 30 cm.

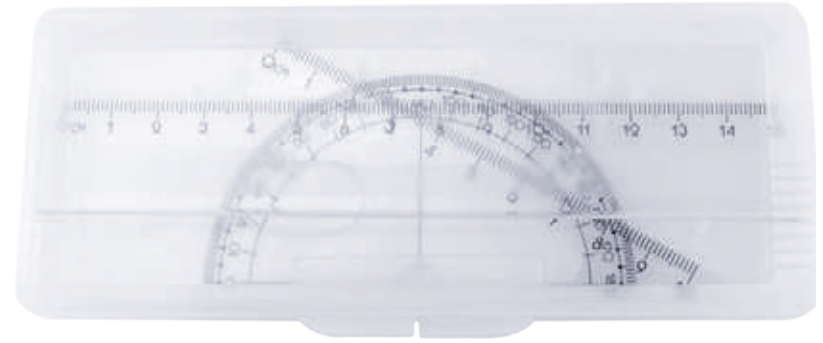
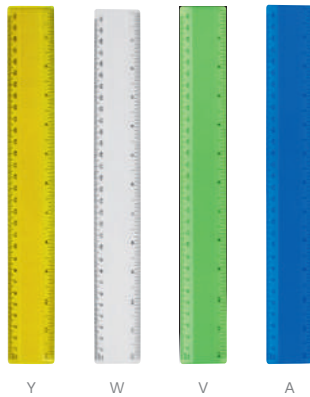

■ INF 012

ESTUCHE DE GEOMETRÍA

Material: Plástico
 Medida: 16.5 x 6.5 cm
 Área de Impresión: 14.5 x 4.5 cm
 Técnica de Impresión: Serigrafía
 Colores: Blanco Frosty
 ■ ■ Colores GTM: Blanco Frosty

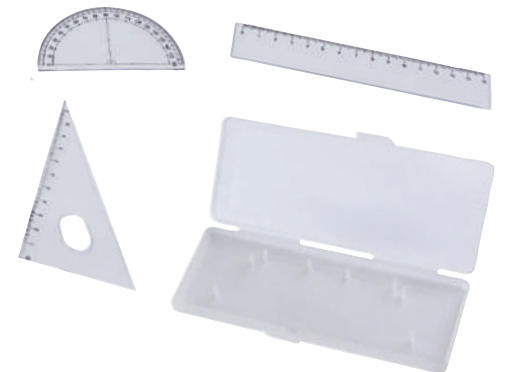
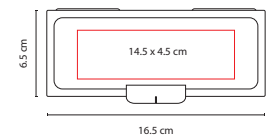

Incluye regla, transportador y escuadra.



■ INF 210

BOLSA PORTA LÁPICES **SARGAS**

Material: Vinil
 Medida: 23.5 x 15.4 cm
 Área de Impresión: 18 x 7 cm
 Técnica de Impresión: Serigrafía
 Colores: Blanco Frosty
 ■ ■ Colores GTM: Blanco Frosty

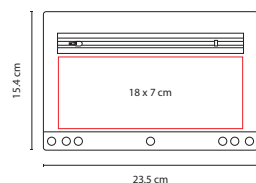

No incluye colores.



■ INF 013

ESTUCHE **URAL**

Material: Plástico
 Medida: 5.9 x 25.5 cm
 Área de Impresión: 2 x 13 cm
 Técnica de Impresión: Serigrafía
 Colores: A/B/O/R/V

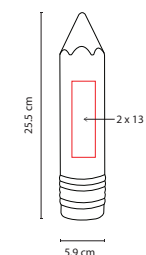



AC

■ INF 600

ESTUCHE ESCOLAR MÁSTER

Material: Plástico
 Medida: 22.2 x 13.2 cm
 Área de Impresión: 17 x 10 cm
 Técnica de Impresión: Serigrafía
 Colores: AC/AR/P/R/T/V

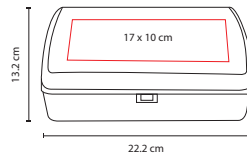

T



P



R



V



AR

Estuche con 4 divisiones. No incluye accesorios.



R

■ INF 150

ESTUCHE HANNAH

Material: Poliéster
 Medida: 29 x 20 cm
 Área de Impresión: 20 x 2 cm
 Técnica de Impresión: Serigrafía
 Colores: A/N/R

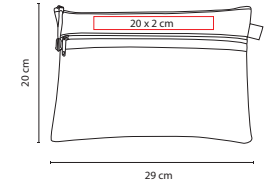

N



A

Bolsa porta lápices con compartimento exterior de malla.



INF 300

CILINDRO CRAYÓN

Material: Plástico
Medida: 7.5 x 22.2 cm

Área de Impresión: 5.2 x 6.5 cm

Técnica de Impresión: Serigrafía / Tampografía

Capacidad: 100 ml Tapa / 500 ml Cilindro

Colores: A/R/V/Y

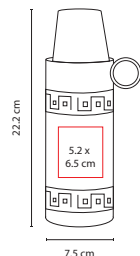

Incluye taza en la tapa.

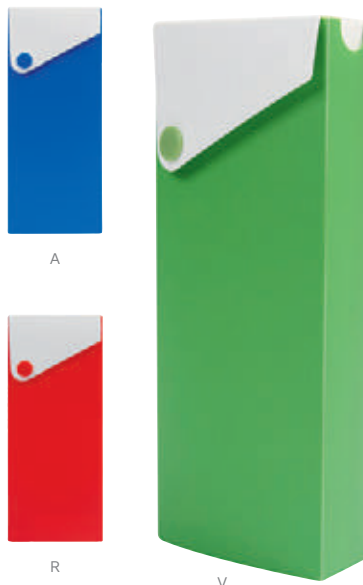

INF 610

ESTUCHE MADY

Material: Plástico
Medida: 7.5 x 19 cm

Área de Impresión: 5 x 12 cm

Técnica de Impresión: Serigrafía

Colores: A/R/V

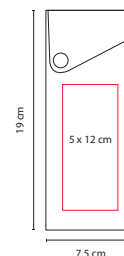

Porta lápices deslizable con botón. No incluye accesorios.



INF 120

ESTUCHE NAPOLI

Material: Plástico
Medida: 20.8 x 7.5 cm

Área de Impresión: 17 x 3.5 cm

Técnica de Impresión: Serigrafía

Colores: A/O/R/V

Colores GTM: A/R/V

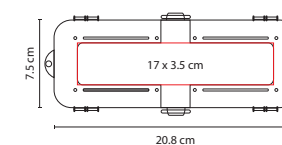

Estuche porta lápices doble.
Compartimentos de 4 y 2 separaciones. No incluye accesorios.



JUGUETES



A

GM 037

CARRITO MONTABLE

Material: Plástico
 Medida: 45 x 41.5 cm
 Área de Impresión: 10 x 5 cm
 Técnica de Impresión: Serigrafía
 Colores: A/R

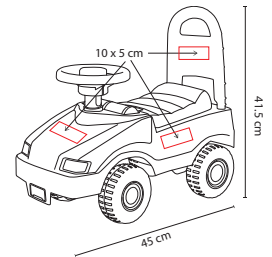

R

Carrito montable para bebé.



GM 033

SPINNER TRIZY

Material: Plástico
 Medida: 7.1 x 6.5 cm
 Área de Impresión: 2 cm Diámetro
 Técnica de Impresión: Serigrafía
 Colores: A/B/R/S

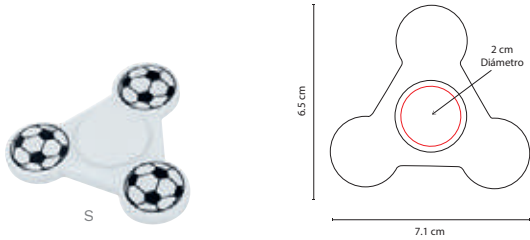

Spinner de 1 balero.



GM 035

SPINNER HÉLIX

Material: Plástico
 Medida: 8 x 7.5 cm
 Área de Impresión: 2 cm Diámetro
 Técnica de Impresión: Serigrafía
 Colores: A/B/R

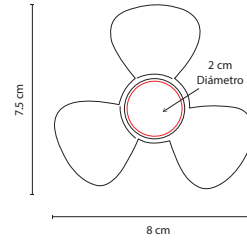

Spinner de 1 balero.



GM 034

CUBO TIC-ZAP

Material: Plástico
 Medida: 3.8 x 3.8 cm
 Área de Impresión: 2.1 x 2.1 cm
 Técnica de Impresión: Goteado en Resina
 Colores: A/N/R

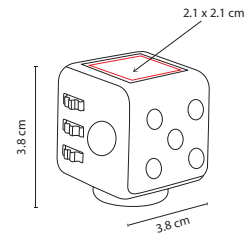

Cubo anti-stress con joystick, giro, engranes, balín y botones. Incluye correa.





■ **GM 029**

PISTOLA DE AGUA **AQUA SKY**

Material: Plástico
 Medida: 50 x 17 cm
 Área de Impresión: 2.5 x 1 cm Pistola /
 10 x 5 cm Cilindro
 Técnica de Impresión: Serigrafía
 Colores: Blanco

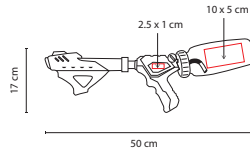

Pistola de agua. Capacidad de cilindro 575 ml.



■ **GM 050**

AVIÓN ARMABLE

Material: Poliestireno
 Medida: 17.5 x 16.5 cm Armado
 Área de Impresión: 6 x 1.5 cm
 Técnica de Impresión: Serigrafía
 Colores: Blanco

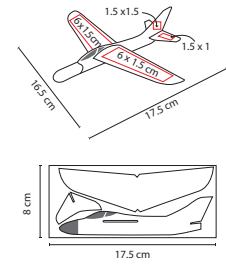

Avión armable blanco con ventanas grises y punta de plástico.



■ GM 031

PIZARRÓN CLOVELLY PAINT

Material: Plástico
 Medida: 21.2 x 13.8 cm
 Área de Impresión: 3 x 4 cm
 Técnica de Impresión: Serigrafía
 Colores: Blanco con Gris

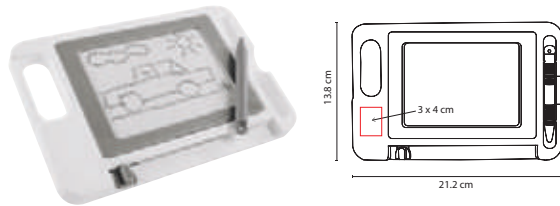

Pizarrón mágico borrrable.



■ GM 010

CUBO ROMPECABEZAS

Material: Plástico
 Medida: 5.5 x 5.5 cm
 Área de Impresión: 5.5 x 5.5 cm
 Técnica de Impresión: Impresión Digital / Serigrafía
 Colores: Blanco
 ■ ■ Colores GTM: Blanco

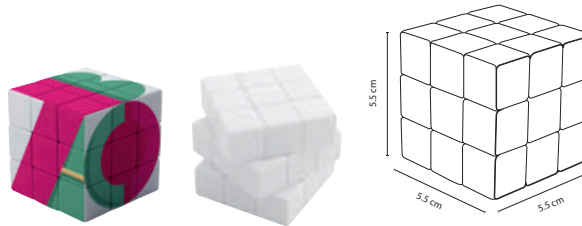

Incluye caja individual.



A

■ GM 032

COHETE PROYECTIL KID

Material: Plástico
 Medida: 2.8 x 20.5 cm
 Área de Impresión: 1.5 x 8 cm
 Técnica de Impresión: Tampografía
 Colores: A/N/R



N



Cohete con elástico para lanzar.



A

■ FREE 005

DISCO VOLADOR **CONTOUR**

Material: Plástico
 Medida: 23 cm Diámetro
 Área de Impresión: 15 cm Diámetro
 Técnica de Impresión: Serigrafía
 Colores: A/B/R/V/Y
 Colores GTM: A/B/R/V/Y

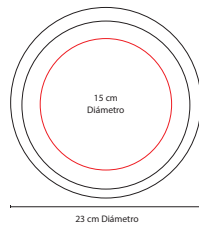

V



R



B



Y



O

■ INF 080

DISCO VOLADOR PLEGABLE

Material: Poliéster
 Medida: 25 cm Diámetro
 Área de Impresión: 22 cm Diámetro
 Técnica de Impresión: Serigrafía
 Colores: A/O/R/V/Y
 Colores GTM: A/O/R/V/Y



V

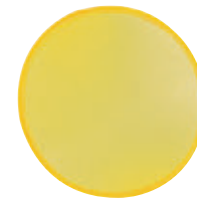

Y



R

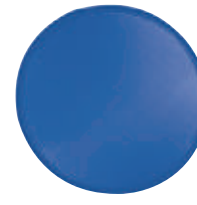

A

Incluye funda.

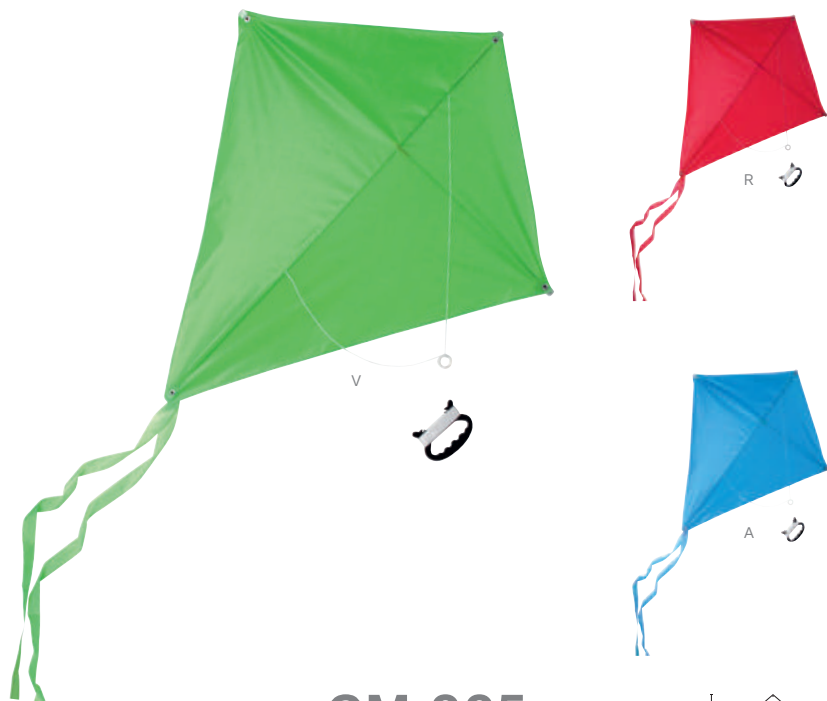

■ GM 005

PAPALOTE **DIAMOND**

Material: Poliéster
 Medida: 58 x 69 cm
 Área de Impresión: 17 x 30 cm
 Técnica de Impresión: Serigrafía
 Colores: A/R/V

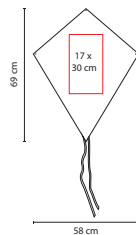

Incluye hilaza de 30 metros.



■ GM 036

ESFERA VOLADORA **FLYLUMINA**

Material: Plástico
 Medida: 5 x 11 cm
 Área de Impresión: 2.5 x 1.5 cm
 Técnica de Impresión: Tampografía
 Colores: Blanco

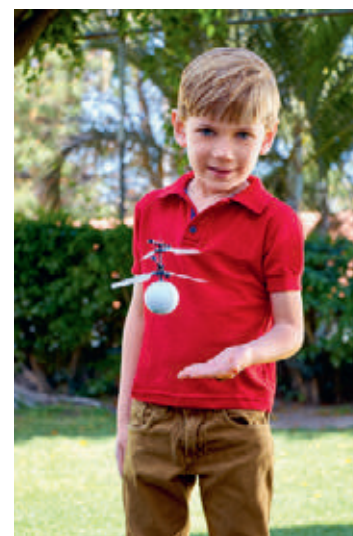
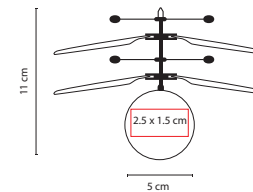

Esfera voladora con sensor de proximidad y batería recargable. Incluye cable cargador USB.



N

INF 015

PELOTA DE PLAYA

Material: Plástico
 Medida: 23 cm Diámetro
 Área de Impresión: 7 x 14 cm
 Técnica de Impresión: Serigrafía
 Colores: B/N

Colores GTM: B/N



B

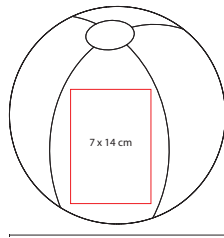

23 cm Diámetro



R

GM 040

OSO TEDDY BEAR

Material: Peluche
 Medida: 11.5 x 13.7 cm
 Área de Impresión: 6 x 3 cm
 Técnica de Impresión: Bordado / Heat transfer
 Colores: A/N/R



N



A

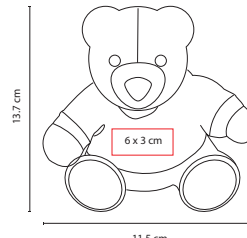

11.5 cm



Incluye sudadera para fácil impresión o bordado.



A

INF 010

YOYO LIGHT

Material: Plástico
 Medida: 5.5 cm Diámetro
 Área de Impresión: 4.4 cm Diámetro
 Técnica de Impresión: Serigrafía
 Colores: A/B/R



B



R

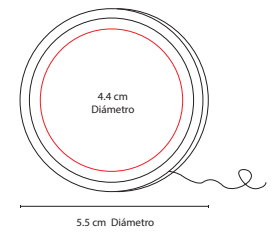

5.5 cm Diámetro

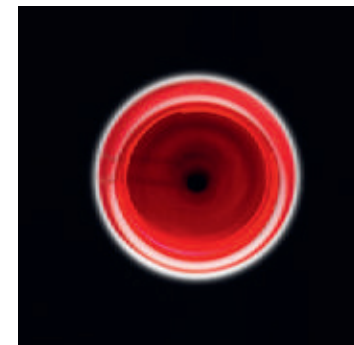

Yoyo con luz. Incluye baterías.



■ INF 030

ALCANCÍA CASITA

Material: Plástico

Medida: 10 x 8.5 cm

Área de Impresión: 5.5 x 2.5 cm

Técnica de Impresión: Serigrafía

Colores: Blanco Frosty

■ Colores GTM: Blanco Frosty

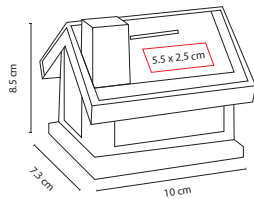

PS

■ INF 040

ALCANCÍA PUERQUITO

Material: Plástico

Medida: 9.7 x 9.7 cm

Área de Impresión: 4.7 x 4.7 cm

Técnica de Impresión: Serigrafía / Tampografía

Colores: BS/PS Sólidos / A/M/O/P/R/V/Y Translúcidos

■ Colores GTM: BS/PS Sólidos / A/R/V/Y Translúcidos

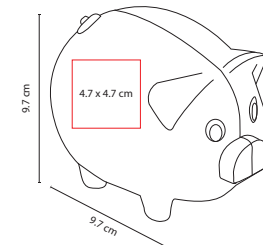



■ **INF 035**

ALCANCÍA DE **CORAZÓN**

Material: Plástico
 Medida: 6.5 x 10 cm
 Área de Impresión: 3 x 3 cm
 Técnica de Impresión: Serigrafía / Tampografía
 Colores: Rojo Translúcido

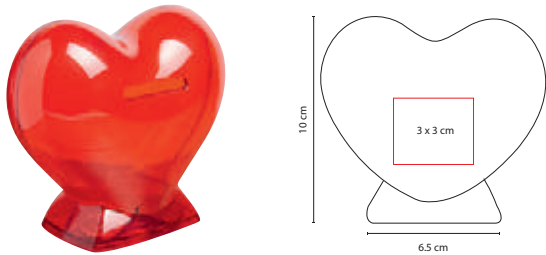

■ **INF 045**

ALCANCÍA **COW**

Material: Plástico
 Medida: 6.5 x 6 cm
 Área de Impresión: 4.5 x 4 cm
 Técnica de Impresión: Serigrafía / Tampografía
 Colores: A/B/R

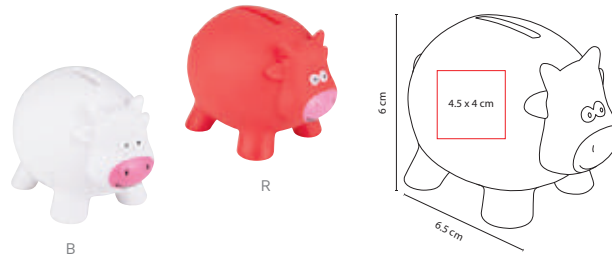

■ **INF 100**

ALCANCÍA **CUBOS**

Material: Plástico
 Medida: 9 x 8.8 cm
 Área de Impresión: 7 x 6.6 cm
 Técnica de Impresión: Serigrafía
 Colores: A/B/R
 Colores GTM: A/B/R

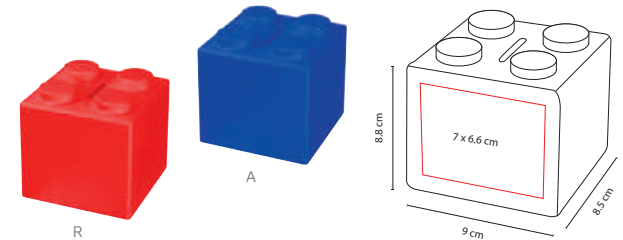

**TIEMPO
LIBRE**





VIAJE



LEN 001

LENTES SUNSET

Material: Plástico
 Medida: 14.1 x 4.8 cm
 Área de Impresión: 6 x 0.8 cm
 Técnica de Impresión: Serigrafía
 Colores: A/B/N/O/P/R/V/Y

Colores GTM: A/B/N/R/V/Y

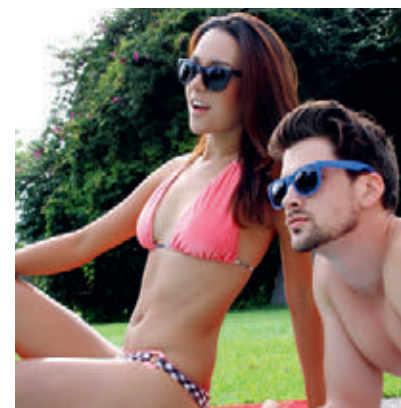
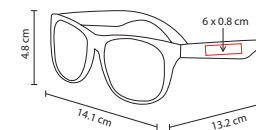

Protección UV 400.



■ LEN 005

LENTES MIRROR

Material: Plástico
 Medida: 14.5 x 5 cm
 Área de Impresión: 3 x 0.7 cm
 Técnica de Impresión: Serigrafía
 Colores: A/O/P/R/V

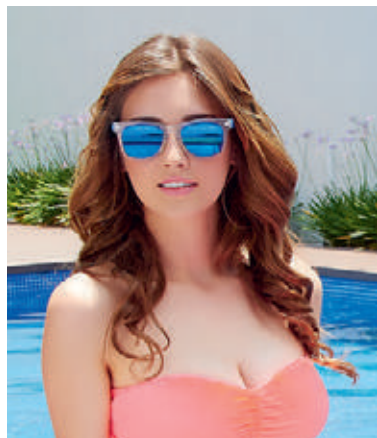
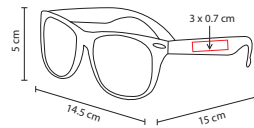

Lente con efecto tornasol. Protección UV 400.



■ LEN 006

LENTES MARONI

Material: Plástico
 Medida: 14.5 x 4.9 cm
 Área de Impresión: 3 x 0.9 cm
 Técnica de Impresión: Serigrafía
 Colores: A/O/P/R/V
 ■ ■ Colores GTM: A/O/R/V

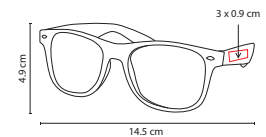

Protección UV 400.





■ **LEN 003**

LENTES **TREVI**SO

Material: Plástico
 Medida: 14.4 x 4.8 cm
 Área de Impresión: 6 x 0.8 cm
 Técnica de Impresión: Serigrafía
 Colores: A/M/N/O/R/V
 Colores GTM: A/N/R/V

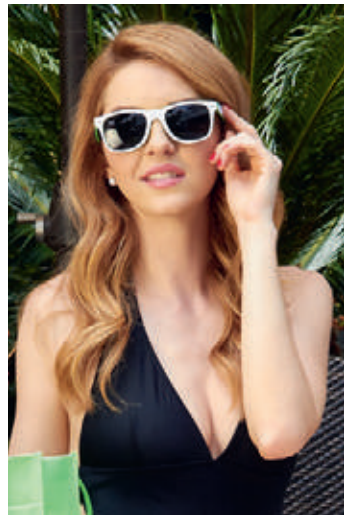

Lentes bicolor. Protección UV 400.



■ **LEN 002**

LENTES **SLANA**

Material: Plástico
 Medida: 14 x 5.5 cm
 Área de Impresión: 3 x 0.6 cm
 Técnica de Impresión: Serigrafía
 Colores: A/N/R/V

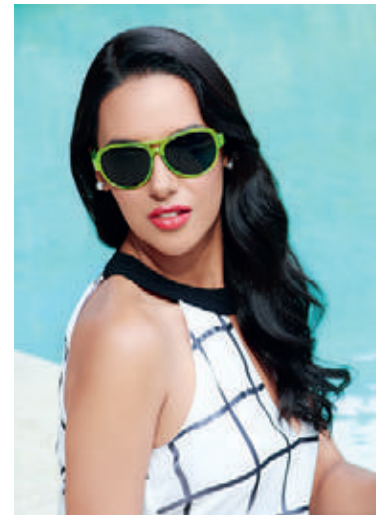
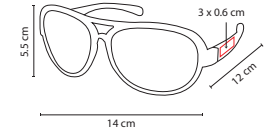

Protección UV 400.



■ ABA 001

ABANICO SEAT

Material: Poliéster
Medida: 22.7 x 32.7 cm
Área de Impresión: 10 x 9 cm
Técnica de Impresión: Serigrafía
Colores: A/O/P/R/V
■ ■ Colores GTM: A/O/R/V

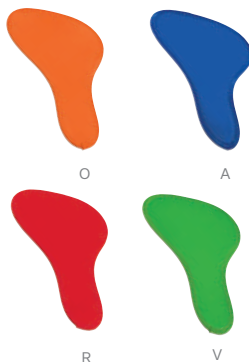
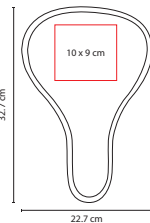

Abanico plegable con elástico.



■ ABA 005

ABANICO AKLAN

Material: Poliéster / Plástico
Medida: 19.5 x 23.8 cm
Área de Impresión: 18 cm Diámetro
Técnica de Impresión: Serigrafía
Colores: Blanco

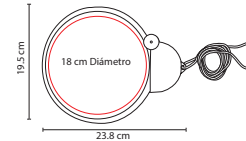

Abanico plegable con base. Incluye cordón.



■ BCH 004

TAPETE DE PLAYA SASSARI

Material: Plástico
Medida: 60 x 180 cm
Área de Impresión: 54 x 17 cm
Técnica de Impresión: Serigrafía
Colores: A/N/R
■ ■ Colores GTM: A/R

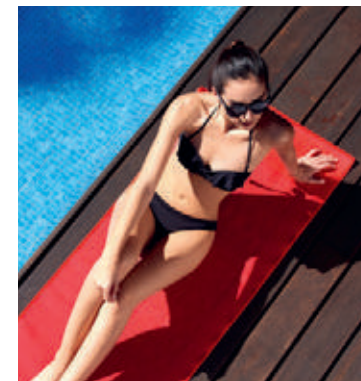
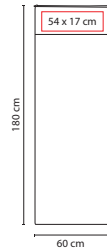

Cuenta con asa para colgar.





A

PRO 115

IDENTIFICADOR DE MALETAS **ARMSTRONG**

Material: Plástico
 Medida: 6 x 11 cm
 Área de Impresión: 4 x 8 cm
 Técnica de Impresión: Serigrafía
 Colores: A/B/N/R
 Colores GTM: A/B/N/R

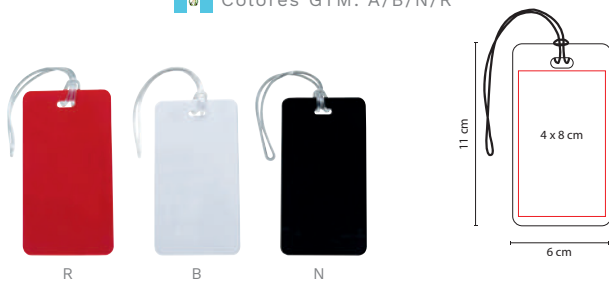

Incluye papel para datos y correa de plástico.



BLQ 001



CANDADO **SARY**

Material: Plástico
 Medida: 2 x 4.3 cm
 Área de Impresión: 1.5 x 1 cm
 Técnica de Impresión: Serigrafía
 Colores: Blanco

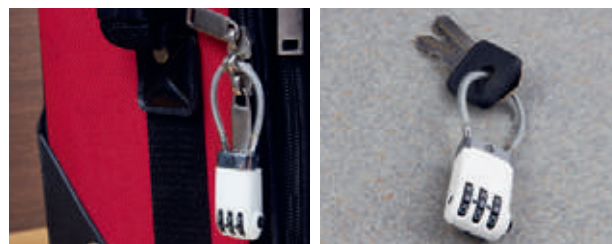

3 Funciones: Llavero, candado para USB para proteger información y candado para maleta. Combinación de 3 dígitos. No incluye USB.



ADC 008

ADAPTADOR **TRAVELER**

Material: Plástico
 Medida: 9.2 x 6 cm
 Área de Impresión: 7 x 4 cm
 Técnica de Impresión: Serigrafía
 Colores: Blanco

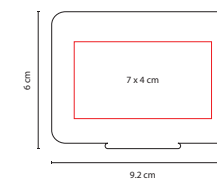

Adaptador universal con entrada USB, protector de seguridad para niños, indicadores de voltaje y con 5 diferentes tipos de clavijas. Incluye estuche.



■ PRO 250

LIMPIA CALZADO **GARSO**

Material: Plástico
Medida: 7 x 2.5 cm

Área de Impresión: 6.4 x 2.2 cm
Técnica de Impresión: Serigrafía
Colores: Blanco

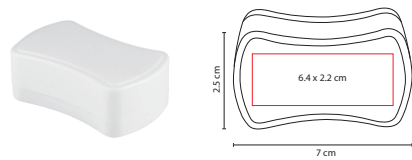

Limpiador de calzado neutro.
Funcional para cualquier color de zapato.



■ PRO 280

LIMPIA CALZADO **KOZIE**

Material: Plástico
Medida: 4.7 x 22 cm

Área de Impresión: 2 x 14 cm
Técnica de Impresión: Serigrafía
Colores: Blanco

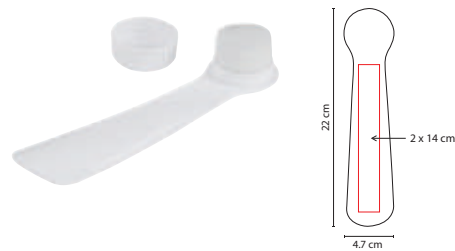

Limpiador de calzado neutro. Mango calzador.
Funcional para cualquier color de zapato.



■ PRO 130

BINOCULARES **BELKA**

Material: Plástico
Medida: 10 x 6 cm

Área de Impresión: 8 x 3 cm
Técnica de Impresión: Serigrafía
Colores: Blanco



Binoculares plegables. Aumento 3X.



■ SLD 020

REPELENTE DE MOSQUITOS

Material: Plástico
Medida: 1.8 x 10 cm
Área de Impresión: 0.8 x 4 cm
Técnica de Impresión: Serigrafía
Capacidad: 16 ml
Colores: Transparente

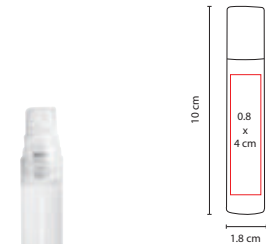

Repelente de mosquitos con más 3 horas de efecto.
No aplicar directo a la cara.





■ COB 001

FRAZADA MINYA

Material: Poliéster
 Medida: 107 x 160 cm
 Área de Impresión: 90 x 150 cm
 Técnica de Impresión: Bordado
 Colores: A/BE/H/N/R



■ BAS 003

BÁSCULA DRESDE

Material: Plástico
 Medida: 14.1 x 3.1 cm
 Área de Impresión: 5 x 2 cm
 Técnica de Impresión: Serigrafía
 Colores: Negro

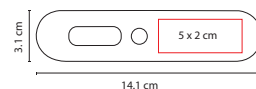

Display digital. Capacidad máxima 45 kg.
 Incluye correa y 1 batería de botón. Unidades de peso: kg y lb.



■ BAS 004

BÁSCULA TINY

Material: Plástico
 Medida: 3.5 x 10 cm
 Área de Impresión: 2 x 1.5 cm
 Técnica de Impresión: Serigrafía
 Colores: Negro
 Colores GTM: Negro

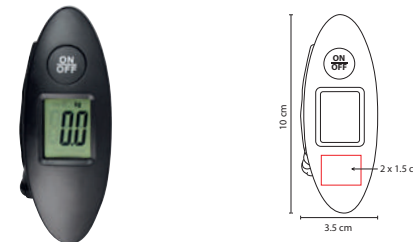

Display digital. Capacidad máxima 40 kg.
 Incluye correa y 1 batería de botón. Unidades de peso: kg y lb.



R

tossh[®] ■ SIN 820

ZAPATERA DINKA

Material: Poliéster
 Medida: 35 x 20 x 14 cm
 Área de Impresión: 13 x 9 cm
 Técnica de Impresión: Bordado / Serigrafía
 Colores: A/R

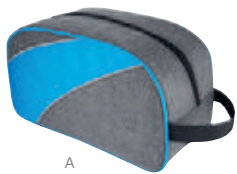

A

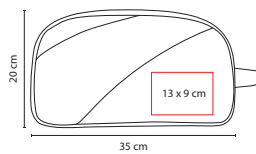

■ SIN 900

ZAPATERA QUEST CLUB

Material: Poliéster
 Medida: 20.8 x 38 x 10 cm
 Área de Impresión: 10 x 13 cm
 Técnica de Impresión: Bordado / Serigrafía
 Colores: Negro con Gris
 ■ Colores GTM: Negro con Gris

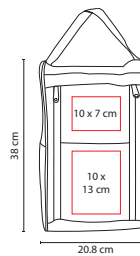

■ SIN 850

SET ORGANIZADOR DE VIAJE CASPERT

Material: Poliéster
 Medida: 50.5 x 41.5 x 11 cm Bolsa Grande /
 41.5 x 31 x 11 cm Bolsa Mediana /
 29 x 21 x 11 cm Bolsa Chica.
 Área de Impresión: 35 x 8 cm Bolsa Grande /
 28 x 5 cm Bolsa Mediana / 18 x 3 cm Bolsa Chica.
 Técnica de Impresión: Serigrafía
 Colores: Gris

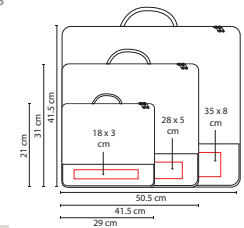

Incluye 3 bolsas de diferentes tamaños para organizar equipaje.





PRO 510

ALMOHADA DARI

Material: Poliéster / Plástico
 Medida: 35 x 25 cm
 Área de Impresión: 12 x 12 cm
 Técnica de Impresión: Serigrafía
 Colores: Gris

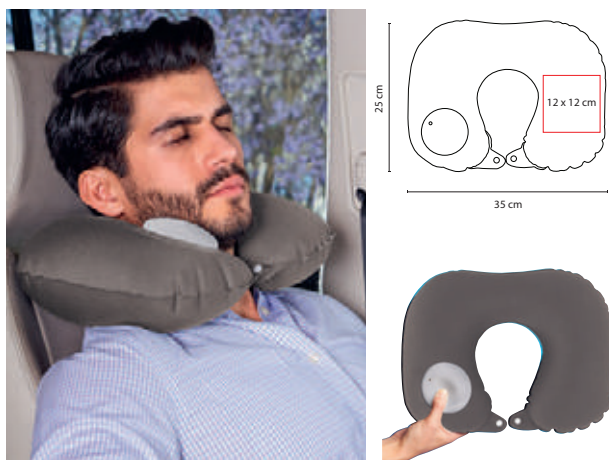

Almohada inflable tipo "U" con sistema Air Push.



PRO 540

KIT REST

Material: Gamuza / Poliéster / Plástico
 Medida: 16 x 10 cm Estuche
 Área de Impresión: 12 x 8 cm
 Técnica de Impresión: Serigrafía
 Colores: Negro
 Colores GTM: Negro



Contiene antifaz para dormir, almohada inflable de viaje, cepillo portátil, un par de tapones para oídos y estuche.



SIN 700

PORTATRAJES BAGOL

Material: Non Woven
 Medida: 58.5 x 105 cm
 Área de Impresión: 18 x 17 cm
 Técnica de Impresión: Serigrafía
 Colores: Negro



Portatrajes con doble asa.



■ DAM 020

NECESER **EVAN**

Material: Poliéster

Medida: 20 x 11 x 10 cm

Área de Impresión: 15 x 7 cm

Técnica de Impresión: Bordado / Serigrafía

Colores: Negro con Gris

■ ■ Colores GTM: Negro con Gris

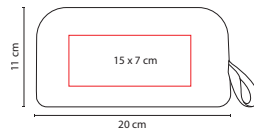

■ NES 003

NECESER **MYOKO**

Material: Curpiel / Poliéster

Medida: 28 x 12 cm

Área de Impresión: 12 x 9 cm

Técnica de Impresión: Bordado / Serigrafía

Colores: Gris

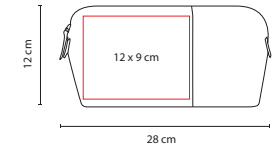



toSSH

■ **SIN 730**

MOCHILA **MAKALU**

Material: Poliéster
Medida: 24 x 29 cm

Área de Impresión: 13 x 12 cm

Técnica de Impresión: Bordado / Serigrafía

Colores: Negro

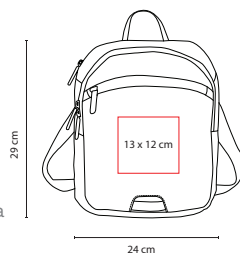

Bolsa principal con un compartimento. Bolsa frontal. Bolsa trasera para tablet. Incluye correa.



■ **NES 002**

NECESER **VARESE**

Material: Curpiel

Medida: 23 x 14.5 x 10 cm

Área de Impresión: 10 x 6 cm

Técnica de Impresión: Láser / Serigrafía

Colores: Café

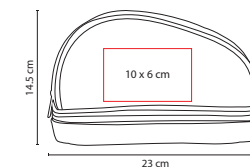

Compartimento inferior con cierre. Asa de curpiel.



■ SIN 310

MOCHILA DE VIAJE **RODNA**

Material: Poliéster
 Medida: 22 x 19 x 11 cm
 Área de Impresión: 15 x 7 cm
 Técnica de Impresión: Bordado / Serigrafía

Colores: Negro

Colores GTM: Negro

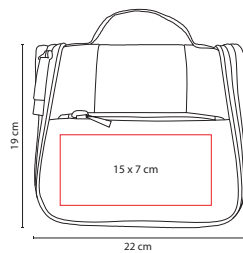

Bolsa con cierre y asa en el exterior.
 Incluye gancho, 2 compartimentos con cierre y 4 bolsas de malla en el interior.



■ SIN 840

ORGANIZADOR **IVERNI**

Material: Poliéster
 Medida: 29 x 16.5 cm
 Área de Impresión: 17 x 4 cm
 Técnica de Impresión: Serigrafía
 Colores: Negro con Gris

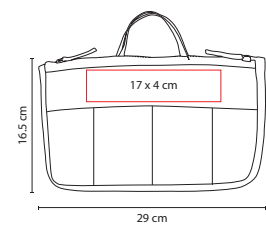

Bolsa central y 2 laterales con cierre. 4 Bolsas de malla en la parte frontal.
 2 Compartimentos y 2 bolsas de malla en la parte trasera.





■ PRO 330

BOLSA PORAK

Material: Plástico
 Medida: 18 x 27 cm
 Área de Impresión: 12 x 15 cm
 Técnica de Impresión: Serigrafía
 Capacidad: 2 Litros
 Colores: Gris

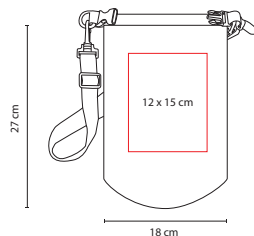

Capacidad 2 litros. Incluye correa.



■ SIN 610

MOCHILA DE VIAJE REISEN

Material: Poliéster
 Medida: 30 x 24 cm
 Área de Impresión: 13 x 14 cm
 Técnica de Impresión: Bordado / Serigrafía
 Colores: Gris

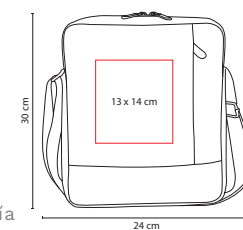

Bolsa frontal y trasera con cierre oculto. 5 Compartimentos internos. Incluye correa ajustable.



prakticasport

SIN 650

CANGURERA SORS

Material: Poliéster / Algodón
 Medida: 27.5 x 9.4 cm
 Área de Impresión: 10 x 5 cm
 Técnica de Impresión: Serigrafía
 Colores: Negro

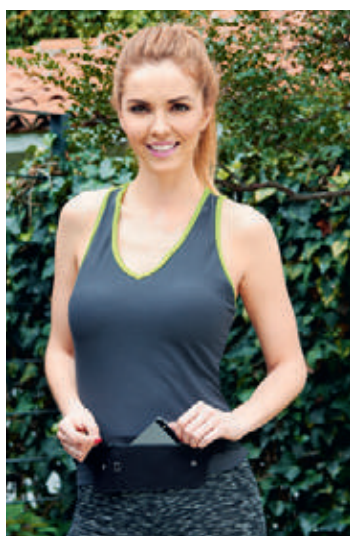
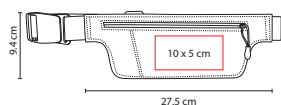

Compartimento principal y bolsa frontal. Incluye elástico para sujetar a la cintura.



SIN 510

PORTA PASAPORTE ALLER

Material: Poliéster
 Medida: 12.5 x 18 cm
 Área de Impresión: 7 x 14 cm
 Técnica de Impresión: Serigrafía
 Colores: Gris

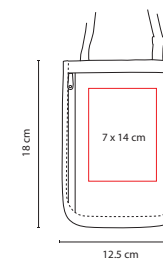

2 Bolsas frontales con cierre.
 Interior con 2 compartimentos multifunción y bolsa con cierre. Incluye correa.





■ **SIN 420**

PORTA DOCUMENTOS **SIERO**

Material: Poliéster
 Medida: 26 x 13.5 cm
 Área de Impresión: 17 x 8 cm
 Técnica de Impresión: Serigrafía
 Colores: Negro
 Colores GTM: Negro

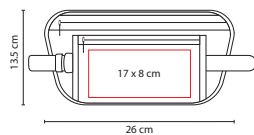

Bolsa frontal con compartimento para llaves y smartphone. Correa elástica ajustable.



■ **M 80520**

PORTA PASAPORTE CARGADOR **REIS**

Material: Curpiel
 Medida: 14 x 24 cm
 Área de Impresión: 9 x 18 cm
 Técnica de Impresión: Serigrafía / Termograbado
 Colores: Negro

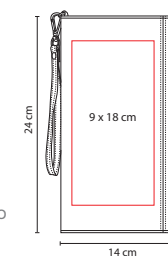

Compartimento para pasaporte, visa, boleto de avión y tarjeta de crédito.
 Batería auxiliar para smartphone, capacidad 4000 mAh.
 Cable adaptador compatible con 8 pin y micro USB. Incluye correa.



■ M 80780

PORTA PASAPORTE

Material: Curpiel
Medida: 12.3 x 22.7 cm
Área de Impresión: 5 x 7 cm
Técnica de Impresión: Láser /
Serigrafía / Termograbado
Colores: Negro
☑ Colores GTM: Negro

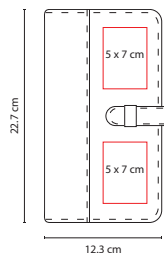

■ M 80640

PORTA PASAPORTE SKANA

Material: Poliéster
Medida: 13.5 x 24 cm
Área de Impresión: 8 x 9 cm
Técnica de Impresión: Serigrafía
Colores: Negro
☑ Colores GTM: Negro

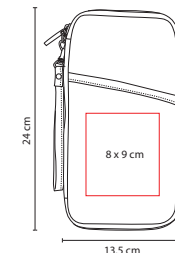

Compartimento para visa, pasaporte, boleto de avión y tarjeta de crédito.



Compartimento para pasaporte, visa, boleto de avión y tarjeta de crédito. Incluye correa.





■ M 80120

PORTA PASAPORTE **LIVIGNO**

Material: Poliéster
 Medida: 10.5 x 14.5 cm
 Área de Impresión: 8 x 8 cm Cubierta /
 3.5 x 1 cm Placa Metálica.
 Técnica de Impresión: Láser en Placa Metálica /
 Serigrafía
 Colores: Gris

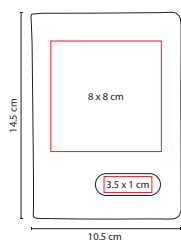

Compartimento para pasaporte, visa y tarjetas.



■ W 750

CARTERA **NANSA**

Material: Curpiel / Forro Textil
 Medida: 11 x 8.6 cm
 Área de Impresión: 8 x 6 cm
 Técnica de Impresión: Serigrafía / Termograbado
 Colores: Negro



Organizador de tarjetas y credenciales.
 Compartimento para billetes.



■ W 650

CARTERA **IMERETI**

Material: Piel Corte Vacuno / Forro Textil
 Medida: 10.2 x 8.5 cm
 Área de Impresión: 8 x 2.5 cm
 Técnica de Impresión: Serigrafía / Termograbado
 Colores: C/N



Organizador de tarjetas y credenciales.
 Compartimento doble para billetes.



DEPORTES



A



■ **SOC 600**

BALÓN KOT

Material: EVA / TPU

Medida: No. 5

Área de Impresión: 14 x 4 cm

Técnica de Impresión: Tampografía

Colores: A/N/R

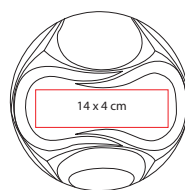

N



R

Cámara blader rubber, 6 gajos. Peso 420 gr. Cosido a máquina.
3 Capas. Nivel máximo de presión 6-8 libras.



■ **SOC 400**

MINI BALÓN PREMIER

Material: EVA / PVC

Medida: No. 2

Área de Impresión: 7 x 1.5 cm

Técnica de Impresión: Serigrafía / Tampografía

Colores: Blanco con Negro y Líneas Plateadas

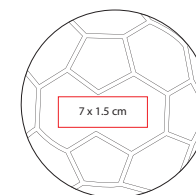

COMPARATIVO DE TAMAÑO
SOC 400 Y EL SOC 500



Cámara blader rubber, 30-32 gajos. Peso 150 gr. Cosido a máquina.
2 Capas. Nivel máximo de presión 2-3 libras.



R



■ SOC 500

BALÓN PREMIER

Material: EVA / PVC

Medida: No. 5

Área de Impresión: 10 x 2 cm

Técnica de Impresión: Serigrafía / Tampografía

Colores: A/N/R

■ Colores GTM: A/N/R

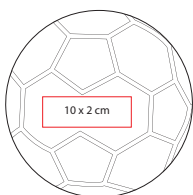

A



N

Cámara blader rubber, 30-32 gajos. Peso 380 gr. Cosido a máquina.
3 Capas. Nivel máximo de presión 6-8 libras.



S



■ SOC 032

BALÓN GALAXI

Material: EVA / PVC

Medida: No. 5

Área de Impresión: 14 x 4 cm

Técnica de Impresión: Serigrafía / Tampografía

Colores: A/R/S

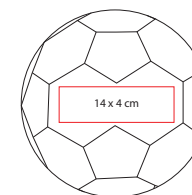

A



R

Cámara blader rubber, 30-32 gajos. Peso 380 gr. Cosido a máquina.
3 Capas. Nivel máximo de presión 6-8 libras.





GLF 08

GANCHO CON MARCADOR DE BOLAS HIT

Material: Curpiel / Metal

Medida: 3.2 x 9.4 cm

Área de Impresión: 2 cm Diámetro

Técnica de Impresión: Láser / Pantógrafo / Serigrafía

Colores: Negro



Marcador magnético de pelota con velcro para los guantes.



GLF 05

CLIP CON MARCADOR DE BOLAS WINNER

Material: Metal

Medida: 3 cm Diámetro

Área de Impresión: 2 cm Diámetro

Técnica de Impresión: Láser / Pantógrafo / Serigrafía

Colores: Plata

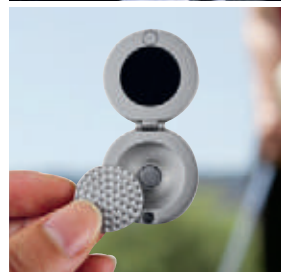
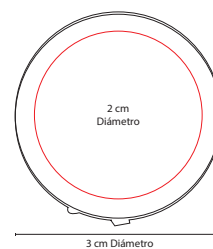

Marcador magnético de pelota con velcro para los guantes.



GLF 07

SACADIVOT PINZÓN

Material: Metal / Rubber

Medida: 3.2 x 6.9 cm

Área de Impresión: 2.4 cm Diámetro

Técnica de Impresión: Goteado en Resina

Colores: Negro

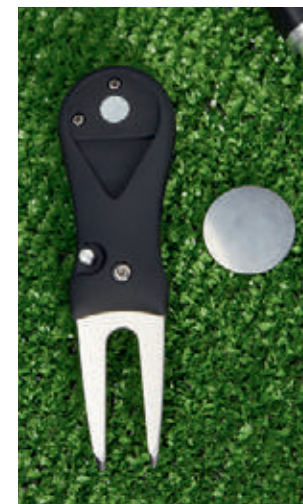

Incluye marcador de pelota.



GLF 011

SET GOLF TEES

Material: Plástico
 Medida: 4 x 10.5 cm
 Área de Impresión: 3 x 5 cm
 Técnica de Impresión: Serigrafía
 Colores: Blanco con Negro

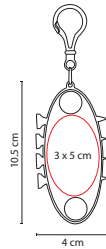

Incluye 2 marcadores de pelota, 4 tees y carabina.



GLF 012

SET DE GOLF AVEIRO

Material: Curpiel
 Medida: 4.5 x 9 cm
 Área de Impresión: 2.5 x 2 cm
 Técnica de Impresión: Láser en Placa Metálica
 Colores: Café

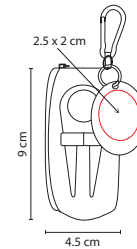

Incluye sacadivot con marcador de bolas, 2 pelotas, 2 tees, carabina, placa metálica para impresión y estuche.





GLF 01

RELOJ Y PORTAPLUMAS GOLF

Material: Curpiel / Metal
 Medida: 9 x 14 cm
 Área de Impresión: 3.5 x 3 cm
 Técnica de Impresión: Láser /
 Pantógrafo / Serigrafía
 Colores: Blanco con Negro

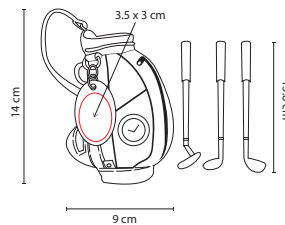

Incluye bolígrafos en forma de palos de golf, tinta negra, roja y azul, placa metálica para impresión. Incluye baterías.



GLF 04

TERMO BOGEY

Material: Acero Inoxidable
 Medida: 8.4 x 24.5 cm
 Área de Impresión: 5.2 x 2.4 cm
 Técnica de Impresión: Tampografía
 Capacidad: 750 ml
 Colores: Blanco con Negro

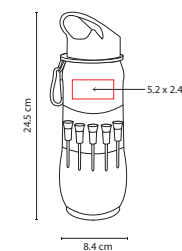

Incluye cinturillo de curpiel, un gancho y 5 tees.



■ SIN 650

CANGURERA SORS

Material: Poliéster / Algodón
 Medida: 27.5 x 9.4 cm
 Área de Impresión: 10 x 5 cm
 Técnica de Impresión: Serigrafía
 Colores: Negro

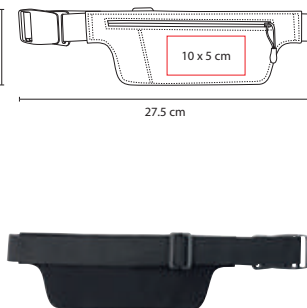

Compartimento principal y bolsa frontal.
 Incluye elástico para sujetar a la cintura.



■ SLD 017

BANDA ELÁSTICA VEYLE

Material: Plástico / Hule
 Medida: 50 cm Extendido
 Área de Impresión: 4 x 1 cm
 Técnica de Impresión: Serigrafía
 Colores: Blanco con Gris

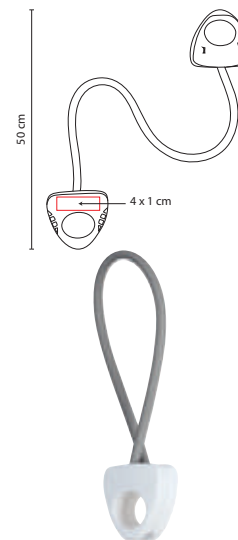

Banda elástica para ejercicio.



■ SPO 002

TOALLA DEPORTIVA LUGA

Material: Poliéster
 Medida: 100 x 30 cm
 Área de Impresión: 10 x 12 cm
 Técnica de Impresión: Bordado / Serigrafía
 Colores: Gris

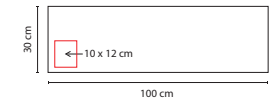
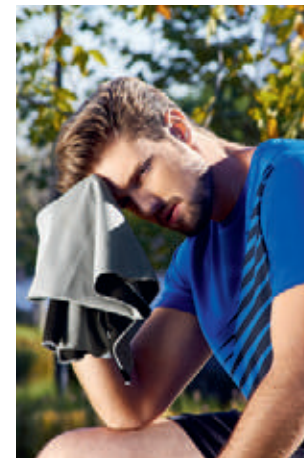

Sistema de enfriamiento instantáneo al contacto con agua.
 Incluye display.





ENTRETENIMIENTO



■ JM 011

JUEGO DE DOMINÓ HABANA

Material: Estuche Aluminio /
Fichas Plástico

Medida: 19 x 12 cm

Área de Impresión: 14 x 8 cm

Técnica de Impresión: Láser / Pantógrafo / Serigrafía
Colores: Plata

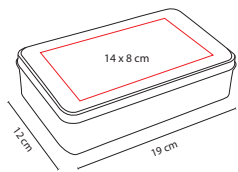

Incluye estuche de aluminio con 1 base central de inicio y 55 piezas.



■ JM 001

JUEGO DE DOMINÓ

Material: Estuche Aluminio /
Fichas Plástico

Medida: 19 x 12.5 cm

Área de Impresión: 13 x 1.5 cm

Técnica de Impresión: Láser / Pantógrafo / Serigrafía
Colores: Plata

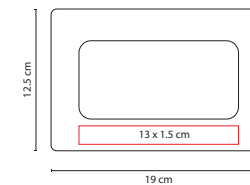

Incluye estuche de aluminio con 28 piezas.





■ JM 002

JUEGO DE DOMINÓ COMPACTO

Material: Estuche Aluminio / Fichas Plástico
Medida: 11.5 x 7.6 cm

Área de Impresión: 9 x 5 cm

Técnica de Impresión: Láser / Pantógrafo / Serigrafía

Colores: Plata

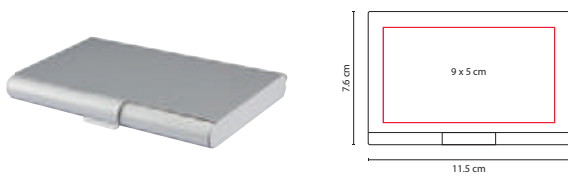

Incluye estuche de aluminio con 28 piezas.



■ JM 009

JUEGO DE CARTAS ROYAL

Material: Curpiel
Medida: 11 x 16 cm

Área de Impresión: 7 x 12 cm

Técnica de Impresión: Serigrafía

Colores: Negro



Estuche de curpiel con 2 barajas plastificadas, libreta y bolígrafo.



■ JM 045

DOMINÓ KATAVI

Material: Estuche Madera / Fichas Plástico
Medida: 18 x 6.1 cm

Área de Impresión: 13 x 3 cm

Técnica de Impresión: Láser / Serigrafía

Colores: Beige

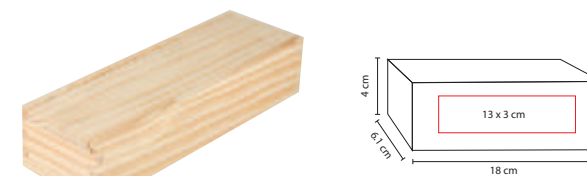

Incluye caja de madera con 28 piezas.



■ JM 050

JUEGO DE DOMINÓ Y CARTAS **ARUA**

Material: Estuche Madera / Fichas Plástico

Medida: 21.5 x 19 cm

Área de Impresión: 16 x 14 cm

Técnica de Impresión: Láser / Serigrafía

Colores: Negro

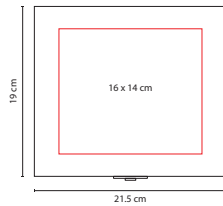

Incluye caja de madera, dominó con 28 piezas, 2 barajas y 5 dados.



■ JM 055

JUEGO DE DOMINÓ **MISURI**

Material: Estuche Curpiel / Fichas Plástico

Medida: 36 x 5.5 cm

Área de Impresión: 28 x 4 cm

Técnica de Impresión: Serigrafía

Colores: Negro

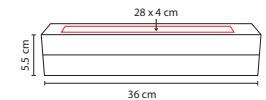

Incluye estuche de curpiel con 28 piezas.





■ JM 014

MINI MALETÍN DE POKER **LUCKY**

Material: Metal / Plástico

Medida: 22.5 x 12.5 cm

Área de Impresión: 4.5 x 3.5 cm

Técnica de Impresión: Láser / Pantógrafo / Serigrafía

Colores: Plata

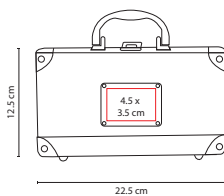

Incluye 50 fichas, 2 barajas plásticas, 1 ficha de dealer y llaves.



■ JM 004

MALETÍN DE POKER **BELLAGIO**

Material: Metal / Plástico

Medida: 30 x 21 cm

Área de Impresión: 8 x 6 cm

Técnica de Impresión: Láser / Pantógrafo / Serigrafía

Colores: Plata

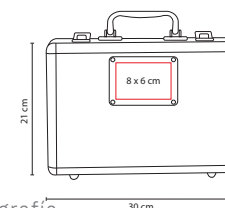

COMPARATIVO JM 004 CON JM 014

Incluye 200 fichas, 2 barajas plasticadas, 5 dados, 1 ficha de dealer y llaves.



■ JM 040

TORRE DE BLOQUES ZINDER

Material: Madera
 Medida: 7 x 1 cm Ficha
 Área de Impresión: 5 x 1.5 cm Ficha
 Técnica de Impresión: Láser / Serigrafía
 Colores: Beige

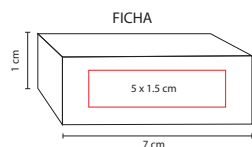

Incluye 60 piezas de madera.



■ JM 017

MALETÍN NAMIBIA

Material: Madera / Plástico
 Medida: 25 x 16.2 cm
 Área de Impresión: 17 x 10 cm
 Técnica de Impresión: Láser / Serigrafía
 Colores: Café

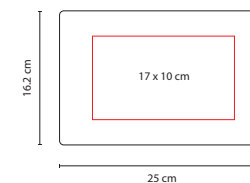

Estuche de madera. Incluye juego de ajedrez, backgammon, 2 barajas plastificadas y dominó.





■ JM 022

CUBILETE CON DESTAPADOR

Material: Plástico / Metal

Medida: 6.5 x 4.5 cm

Área de Impresión: 4 x 2 cm

Técnica de Impresión: Serigrafía / Tampografía

Colores: Negro

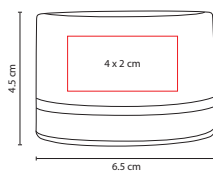

Incluye 5 dados y destapador.



■ JM 021

CUBILETE KENTAUR

Material: Curpiel

Medida: 7.5 x 8.7 cm

Área de Impresión: 4.5 x 4 cm

Técnica de Impresión: Serigrafía

Colores: Negro con Gris

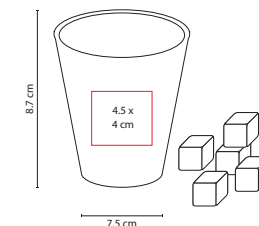

Incluye 5 dados.



■ JM 030

RULETA MONTECARLO

Material: Cristal / Plástico
 Medida: 71 x 46 cm
 Área de Impresión: 20 x 8 cm
 Técnica de Impresión: Serigrafía
 Colores: Negro

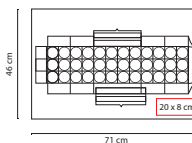
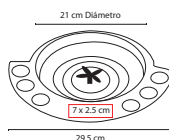

Incluye tapete, 6 vasos y 2 balines.



■ JM 065

MINI PONG JERICO

Material: Madera / Plástico
 Medida: 44.8 x 15.8 cm
 Área de Impresión: 10 x 3 cm
 Técnica de Impresión: Láser / Serigrafía
 Colores: Beige con Negro

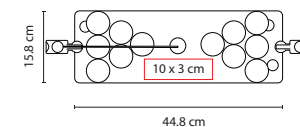

Base para mini beerpong con 12 vasos y pelota.



Rainbow®

Agencia de Comunicación

toSSH®

2drink.

ZEGNO®

STARTECHNO®

prisma®

ZEGNO®
ESCRITURA

XO-TOOL®

igni®

prakticasport®

Premec®
SWISS WITH PRIDE

erga
Italian works of art since 1948

Swissdigital®